



EXCEL
MACHINE TOOLS
'Always Excel'

metalkraft®

METAL WORKING MACHINERY



MAIN CATALOGUE 2019
OFFERS FOR TRADE CUSTOMERS

Table of contents

Drilling	
Magnetic drilling machines	
MB Series	9
Taps	14
Accessories	16
Deburring	
Edge deburrer	
KE Series	30
Metal grinding	
Satin finishing machine	
SM 100	36
Pipe sanding machine	
RSM 620	38
RSM 760	39
Brush deburring sander	
BEG 250 / BEG 250 S	40
Belt and disc sander	
BTS 51	41
Extraction units	
AS 1400, AS 1601	41
Combined sander	
KRBS 101	42
Belt sanders	
MBSM	44
Long belt sanding machine	
MBSM ESE	48
Sanding belts for MBSM series	
	50
Precision surface-grinding machine	
FSM	52
Cutting	
Rotary shears	
KS 1 (manual)	58
KS2 (motorised)	58
Manual guillotine shears	
BSS	58
Manual precision guillotine shears	
TBS	59
Manual guillotine shears	
TBS	60
Foot-operated guillotine shears	
FTBS 1050-10	61
Precision guillotine shears	
FTBS M	62
FTBS P	63

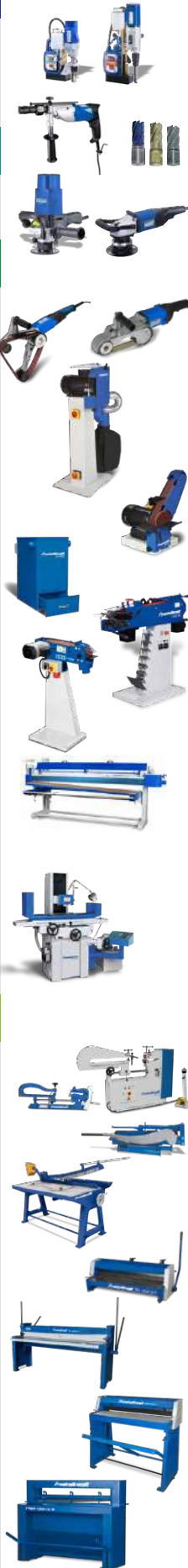

Motorised guillotine shears	
MTBS motorised	64
MTBS E	65
MTBS B	66
MTBS motorised (heavy duty version)	68
MTBS T	70
Hydraulic guillotine shears	
HTBS-T	72
HTBS-K	74
Notching & punching	
Manual pipe notcher	
MRA	78
Notching machines	
AKM 100 T	78
AKM P	79
AKM H	80
AKM V	81
Hydraulic section steel shears/ hole punches	
HPS	82
Hydraulic hole punches	
HLS	86
Punches and dies	
	87
Bending	
Pressing and stretching machine	
SSG	92
Angle bender	
WB 100	93
Hydraulic pipe bender	
HRB 10	93
Universal and pipe bending machines	
UB 10	94
UB 11	95
RB 30	96
RB 12	97
Hydraulic horizontal bending press	
Serie HBP New	98
Pipe bending machines without mandrels	
RB Series New	102
BM series	104
Ring bending machine	
PRM	107
PRM F Series	108
PRM FH Series	112
Bead bending machines	
SBM	123
SBM E	124
Plate rolling machines	
RBM	126
RBM E	128
RBM E PRO	130
RBM 4 HMS PRO	132
Combined bending/cutting machines	
SRWS KOMBI	134



Manual brake bending machines

HSBM	135
HSBM 3200-0.7	136
HSBM SB	138

Folding machines

MBM 1250	139
HSBM N	140
FSBM	142
HSBM	144
MSBM	146
MSBM PRO	148

Bending brakes

GBP-E	160
GBP-R	162
GBP-S	166

Presses

Table top workshop presses

WPP T	174
-------	-----

Workshop presses

WPP 175	
WPP BK	176

Workshop presses with electric pump

WPP M	177
-------	-----

Heavy duty workshop presses

WPP HBK	178
WPP VH	180
WPP RP	182
WPP RFP	183
WPP RT	184

All hydraulic tyre press

RPP	185
-----	-----

Universal frame presses

RP U	186
------	-----

Frame presses with unit to bend edges

RP A	187
------	-----

Hydraulic C rack presses

HP C	188
------	-----

Circular saws

Manual metal-cutting circular saws

HKS 230	196
---------	-----

Metal dry cutter

MTS 356	197
---------	-----

Metal-cutting circular saws

MKS N	198
MKS R	200
MKS	201
MKS H	201

Vertical metal-cutting circular saws

MKS V	202
MKS VH	203
MKS VA	204

Light alloy metal-cutting circular saws

LMS / LMS H / LMS P	206
LMS A	207

Underground light metal cutting circular saw

ULMS 	208
--	-----

Sliding table saws

minimax si 400es 26 ALU 2 	210
---	-----



Saw blades

Universal chassis	212
UF 300	214

Material supports

MS	214
----	-----

Roller conveyors

Roller and measuring tracks

MRB LC	215
Assembly adapter MRB LC	216
MRB Standard	217
Accessories	218

Metal-cutting band saws

Metal-cutting band saws

MBS	220
-----	-----

Vertical metal-cutting band saws

VMBS	222
------	-----

Explanation of controls

BMBS 220 x 250 H-G	232
--------------------	-----

BMBS 230 x 280 H-DG / HA-DG	234
-----------------------------	-----

BMBS 230 x 280 CNC-G	236
----------------------	-----

BMBS 250 x 315 H-DG / HA-DG	238
-----------------------------	-----

BMBS 300 x 320 H-DG	240
---------------------	-----

BMBS 300 x 320 HA-DG	242
----------------------	-----

BMBS 300 x 320 CNC-G	244
----------------------	-----

BMBS 360 x 500 CNC-G 	246
--	-----

BMBS 460 x 600 HA-DG	248
----------------------	-----

HMBS 340 CNC-DG-X	250
-------------------	-----

HMBS 500 x 750 HA-DG/ HA-DG X	252
-------------------------------	-----

HMBS 500 x 750 NC-DG X BC 2000 	254
--	-----

HMBS 300 x 300 CNC X	256
----------------------	-----

HMBS 400 CNC	258
--------------	-----

HMBS 400 x 400 CNC X	260
----------------------	-----

HMBS 510 x 510 CNC X	262
----------------------	-----

HMBS 5000 CNC X	264
-----------------	-----

HMBS 700 x 750 HA X	266
---------------------	-----

HMBS 700 x 750 CNC X	268
----------------------	-----

HMBS 850 x 1 000 CNC X	270
------------------------	-----

HMBS 1200 x 1400 HA X	272
-----------------------	-----

HVMS 850 x 1 000 Xtreme	274
-------------------------	-----

HVMS 1200 x 1600 Xtreme	276
-------------------------	-----

Saw bands

	280
--	-----





The solution for loose rivet nuts

Secure threaded connections for thin wall thicknesses

THERMADRILL®

Verbindungstechnik – Made in Germany

The Thermdrill® method

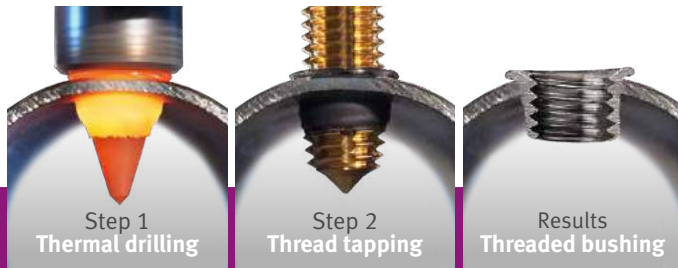

In thermal drilling, the friction heat from the existing material is used to create an anti-twist protected bushing without material removal in which a thread is then tapped.

- For aluminium, brass, copper, steel, stainless steel as of 1.0 mm wall thickness
- For use with milling cutters, CNC systems and post drills

www.thermdrill.de

- ✓ Cost savings
- ✓ Time savings
- ✓ Maximum safety

1 Thermal drill



- Suitable for aluminium, non-ferrous metal, steel and stainless steel
- Made of solid carbide with a special polygon grind

Size	Type	Max. material thickness [mm]	Art. no.	Max. material thickness [mm]	Art. no.
M4	short	1.5	3060104	2.0	3060164
	long	2.5	3060124	4.0	3060144
M5	short	2.0	3060105	3.0	3060165
	long	3.0	3060125	4.5	3060145
M6	short	2.0	3060106	3.0	3060166
	long	3.5	3060126	5.0	3060146
M8	short	2.5	3060108	4.0	3060168
	long	4.0	3060128	6.0	3060148
M10	short	2.5	3060110	4.0	3060170
	long	4.5	3060130	6.5	3060150
M12	short	2.5	3060112	4.0	3060172
	long	4.5	3060132	6.5	3060152

Other thread sizes available (also in metric fine and pipe threads)

2 Thread taper



- Legacy tool fittings can be used

Size	Art. no.
M4 x 0.7	3060184
M5 x 0.8	3060185
M6 x 1.0	3060186
M8 x 1.25	3060188
M10 x 1.25	3060190
M12 x 1.25	3060192

3 Basic equipment



Contains everything you need to get started with the THERMADRILL right away

Shank	Art. no.
MK 2	3060005

Contents:

- ▶ THERMADRILL Paste 100 g
- ▶ Thread tapping oil 100 ml
- ▶ Open-end wrench
- ▶ Hook wrench
- ▶ Tool holder with cooling ring MK 3
- ▶ Case
- ▶ Reduction sleeve MK 3 - MK 2
- ▶ Spring collets (Ø 6/8/10/12 mm)

Tool set = Thermal drill + thread taper

Type SHAPE				Type CUT	
Size	Type	Max. material thickness [mm]	Art. no.	Max. material thickness [mm]	Art. no.
M4	short	1.5	3060024	2.0	3060044
	long	2.5	3060034	4.0	3060054
M5	short	2.0	3060025	3.0	3060045
	long	3.0	3060035	4.5	3060055
M6	short	2.0	3060026	3.0	3060046
	long	3.5	3060036	5.0	3060056
M8	short	2.5	3060028	4.0	3060048
	long	4.0	3060038	6.0	3060058
M10	short	2.5	3060030	4.0	3060050
	long	4.5	3060040	6.5	3060060
M12	short	2.5	3060032	4.0	3060052
	long	4.5	3060042	6.5	3060062

Other thread sizes available (also in metric fine and pipe threads)

THERMADRILL Paste

Container	Art. no.
1 kg	3060090

For friction drilling including brush

Protects the thermal drill against excessive wear.

Thread tapping oil

Container	Art. no.
1 litre	3060092

Including brush

High-performance oil, specially suited for thread tapping in aluminium, copper, brass, steel, stainless steel,

Overview **metalkraft** Magnetic core drilling machines



MB 351



MB 502 E



MB 502



MB 754



RB 127



MB 351 F



MB 1204



MB 202 G

Magnetic drilling

Modell	MB 351	MB 502 E	MB 502	MB 754	MB 1204	RB 127	MB 351 F	MB 202 G
	Feed manual	Feed manual	Feed manual	Feed manual	Feed manual	Feed manual	Feed manual	Feed manual
Technical specifications								
Keyhole sawing max. Ø	-	-	-	-	-	127 mm	-	-
Max. drill Ø / Core drilling	35 mm	50 mm	50 mm	75 mm	120 mm	-	35 mm	35 mm
Max. drilling depth / Core drilling	50 mm	50 mm	75 mm	50 mm	75 mm	-	30 mm	50 mm
Max. drill bit Ø/Full drilling ¹	-	-	-	32 mm	32 mm	-	-	13 mm
Max. drilling depth/Full drilling ¹	-	-	-	150 mm	150 mm	-	-	110 mm
Max. drill bit Ø/Full drilling ²	13 mm	13 mm	16 mm	16 mm	16 mm	-	-	-
Max. drilling depth/Full drilling ²	140 mm	140 mm	110 mm	110 mm	110 mm	-	-	-
Spindle holder	M 27	Fixed	M 27	MK 3	MK 3	5/8"-16	Fixed	Fixed
Weldon shaft holder	19 mm	19 mm	19 mm	19 mm	19 mm	-	19 mm	19 mm
Speed under load in rpm	330	180/270	230/300	90/120/180/230	120/220/250/450	-	390	330
Motor output	1 100 Watts	1 100 Watts	2 000 Watts	2 000 Watts	2 000 Watts	1 100 Watts	1 100 Watts	1 100 Watts
Electrical connection	230 V/50 Hz	230 V/50 Hz	230 V/50 Hz	230 V/50 Hz	230 V/50 Hz	230 V/50 Hz	230 V/50 Hz	230 V/50 Hz
Magnetic foot dimensions	165 x 80 mm	180 x 90 mm	200 x 100 mm	200 x 100 mm	210 x 120 mm	-	165 x 80 mm	180 x 80 mm
Magnetic holding force	15 000 N	17 000 N	32 000 N	32 000 N	32 000 N	-	15 000 N	15 000 N

1) with directly mounted full drill 2) with mounted drill chuck adapter and drill chuck

More economical and faster drilling:

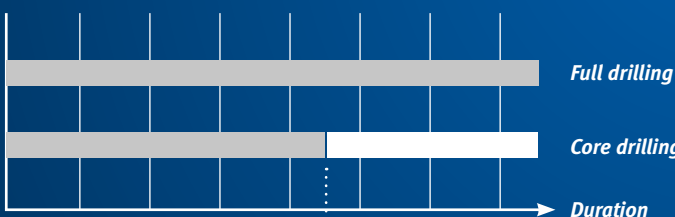

Up to 40% time and cost savings



Full drilling:

- Pre-drilling usually necessary
- Time-consuming tool changes for large drill Ø
- Large machining area
- High energy expenditure
- Poorer drill hole quality (burr)

Core drilling:

- No centring or preliminary drilling necessary
- The smaller machining area means you are much faster while needing less energy
- Drilling to max. 120 mm Ø, also overlapping
- Highest quality (burr, surface)
- Significantly more economical than full drilling
- Rapid tool change via "Lock & Load" system apart from MB 754/1204



- Fastening element**
Specially for the MB 754 magnetic drilling machine
- ▶ For fastening the machine on pipes with a diameter of 32 – 203 mm
 - ▶ Easy to install
 - ▶ Stable and reliable

Art no. 3867504
€205.00 plus VAT

MB 754



- Four speeds
 - 2 000 Watt motor
 - Max. magnetic holding force of 32 000 N
- Spindle holder MK 3
- Clockwise/Anti-clockwise rotation

MB 1204



- Four variable speed ranges
 - 2 000 Watt motor
 - Max. magnetic holding force of 32 000 N
- Spindle holder MK 3
- Clockwise/Anti-clockwise rotation



Various speeds adjustable with the following models MB 502, MB 502 E, MB 754 and 1204



Quick-release chuck (for MB 351 and MB 502)



Conversion from core to full drilling with just a few actions

Core drilling benefits

More economical and faster drilling:

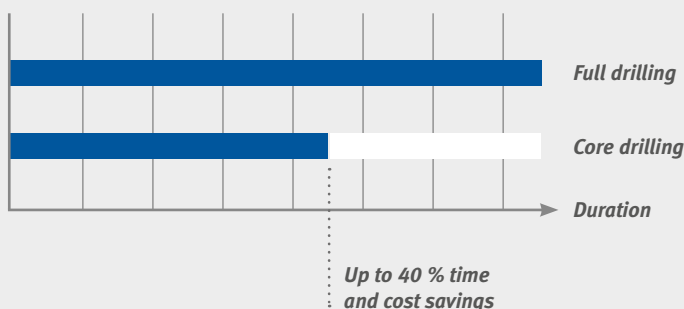

Full drilling:

- Pre-drilling usually necessary
- Time-consuming tool changes for large drill Ø
- Large machining area
- High energy expenditure
- Poorer drill hole quality (burr)

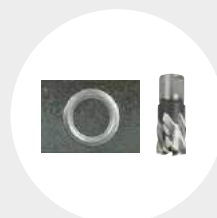

Core drilling:

- No centring or preliminary drilling necessary
- The smaller machining area means you are much faster while needing less energy
- Drilling to max. 120 mm Ø, also overlapping
- Highest quality (burr, surface)
- Significantly more economical than full drilling
- Rapid tool change via "Lock & Load" system apart from MB 754/1204

Magnetic drilling machines

MB – High-quality magnetic core drilling machines for versatile use.

RB – Pipe drilling machine with keyhole saw and low installation height.

- ▶ For core drills with 19 mm Weldon shaft (apart from RB 127)
- ▶ Stable drilling guidance thanks to long and particularly deep mounted spindle sleeve holder
- ▶ Device is earthed and double isolated, hence ideal for building sites

- ▶ High magnetic holding force (apart from RB 127)
- ▶ High-quality mechanical design
- ▶ The coolant is routed through the drill (apart from RB 127 and MB 351 F)
- ▶ Conversion from core to full drilling in just a few actions

Special features MB 202 G

- ▶ Integrated, automatic coolant supply
- ▶ Tapping drill direction of rotation can be changed without changing the direction or stopping of the motor
- ▶ 3 functions: Thread tapping, core drilling and full drilling

MB 202 G



- Integrated automatic coolant supply
- Tapping drill direction of rotation can be changed (without changing the direction or stopping of the motor)
- 3 functions: Thread tapping, core drilling and full drilling

RB 127



With integrated spirit level



- 1 Speed
- 1 100 Watt motor
- Integrated spirit level

Model	MB 202 G	RB 127	MB 351 F
Art. no.	3862000	3860127	3860350
	Feed manual	Feed manual	Feed manual
Technical specifications			
Keyhole sawing max. Ø	-	127 mm	-
Max. drill Ø / Core drilling	35 mm	-	35 mm
Max. drilling depth / Core drilling	50 mm	-	30 mm
Max. drill Ø / Full drilling ¹	13 mm	-	-
Max. drilling depth / Full drilling ¹	110 mm	-	-
Spindle holder	Fixed	5/8"-16	Fixed
Weldon shaft holder	19 mm	-	19 mm
Speed under load in rpm	330	-	390
Motor output	1 100 Watts	1 100 Watts	1 100 Watts
Electrical connection	230 V / 50 Hz	230 V / 50 Hz	230 V / 50 Hz
Magnetic foot dimensions	180 x 80 mm	-	165 x 80 mm
Magnetic holding force	15 000 N	-	15 000 N
Max. dimension in mm	280 x 205 x 395	319 x 270 x 302	285 x 101 x 200
Weight	13.7 kg	14.5 kg	10 kg

1) with mounted drill chuck adapter and drill chuck

Scope of delivery MB 202 G:

- > 1 coolant tank and coolant line
- > 1 Protection device
- > Operating tool
- > Plastic carrying case
- > Adapter, universal chuck for M5 to M22 taps and quick release system for core drill bits and taps

Scope of delivery RB 127, MB 351 F:

- > 1 Protection device
- > Operating tool
- > Plastic carrying case
- > Holder for pipes 32 - 203 mm (RB 127)
- > Integrated spirit level (RB 127)



RB 127
Holder for pipes 32 - 203 mm

Special features pipe drill RB 127

- ▶ Integrated spirit level
- ▶ Cutting holes up to 127 mm possible
- ▶ Horizontal and vertical working position possible
- ▶ Holder for pipes with simple quick-release system and chain
- ▶ Low installation height

Special features MB 351 F

- ▶ Balanced carrying comfort
- ▶ Operating lever can be used on both sides
- ▶ LED light for dark work areas
- ▶ Practical and lightweight
- ▶ Optimum use in cramped conditions

MB 351 F



With freely adjustable lever



LED light for 'dark work areas'



Flat version

- 1 Speed
- With quick-release chuck
- 1 100 Watt motor
- LED light for dark work areas
- Operating lever can be used on both sides

Core drilling benefits

More economical and faster drilling:

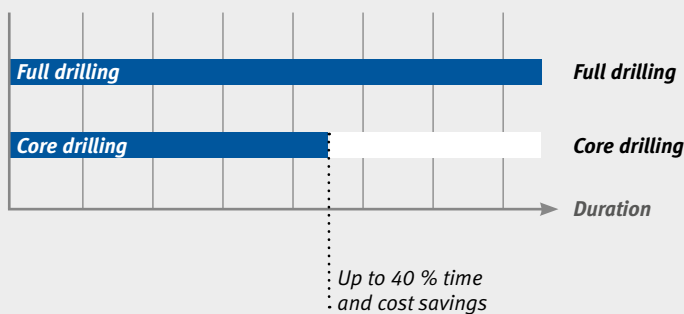

Full drilling:

- Pre-drilling usually necessary
- Time-consuming tool changes for large drill Ø
- Large machining area
- High energy expenditure
- Poorer drill hole quality (burr)

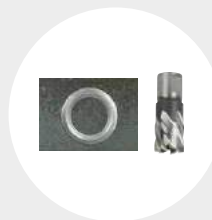

Core drilling:

- No centring or preliminary drilling necessary
- The smaller machining area means you are much faster while needing less energy
- **Drilling to max. 120 mm Ø, also overlapping**
- Highest quality (burr, surface)
- Significantly more economical than full drilling
- **Rapid tool change via "Lock & Load" system apart from MB 754/1204**

Electrical thread tap

GS 18 – Electric thread tap with reversing gear for time-saving, precise tapping of threads in drilled holes

- ▶ Reversing gear allows for very fast processing: pressure on the spindle starts slow clockwise action of the tool. Pulling back automatically enables quick reverse at 680 rpm
- ▶ Easy thread tapping in a single step thanks to high torque, low speed and excellent concentricity precision
- ▶ Additional handle allows for optimum and convenient tool guidance
- ▶ Compensates for cutting tool angular offset in the borehole thanks to an articulated coupling between the chuck adapter and threaded chuck
- ▶ For drilling blind holes

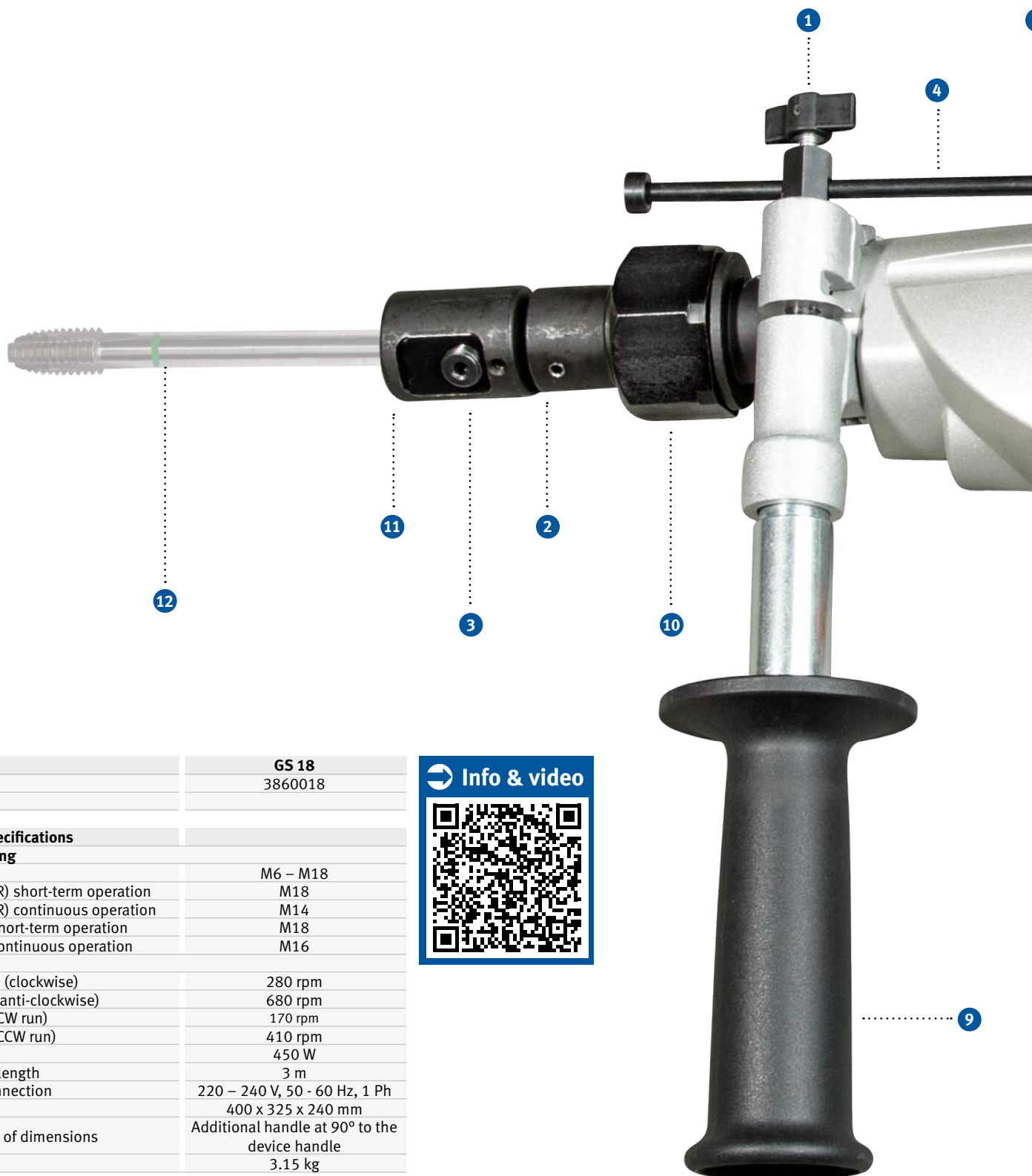

Model	GS 18
Art. no.	3860018
Technical specifications	
Thread tapping	
screw tap	M6 – M18
Steel (S235JR) short-term operation	M18
Steel (S235JR) continuous operation	M14
Aluminium short-term operation	M18
Aluminium continuous operation	M16
Speeds	
Idle forwards (clockwise)	280 rpm
Idle reverse (anti-clockwise)	680 rpm
Under load (CW run)	170 rpm
Under load (CCW run)	410 rpm
Rating	450 W
Power cable length	3 m
Electrical connection	220 – 240 V, 50 - 60 Hz, 1 Ph
Dimensions	400 x 325 x 240 mm
Explanations of dimensions	Additional handle at 90° to the device handle
Weight	3.15 kg



- › Reversing gear for fast and easy thread tapping
- › Precision thanks to high torque, low speed and excellent concentricity precision
- › Universal chuck with slip clutch for longer tool service life
- › Compensates for cutting tool angular offset thanks to articulated coupling

Scope of delivery GS 18:

- › Universal chuck M6 –M18 with slip clutch
- › Additional handle
- › 4 mm Allen key
- › Depth stop
- › Transport case



Transport case

- 1 Tightening screw
- 2 Rotating head
- 3 Tightening screw
- 4 Depth stop
- 5 Housing
- 6 Motor
- 7 Handle
- 8 On switch
- 9 Side handle
- 10 Safety slip clutch

- 11 Universal chuck
- 12 Thread tapper (not included in scope of delivery)



Magnetic drilling



Deburring

Reversing gear for short processing duration: pressure on the spindle starts slow clockwise action, reversing automatically enables fast action

Metal grinding



Cutting

Depth stop and universal chuck for standard thread tap from M6 to M18 included in scope of delivery

Notching & punching



Bending

Compensates for cutting tool angular offset in the borehole thanks to an articulated coupling between the chuck adapter and threaded chuck









Presses

Circular saws

Roller conveyors







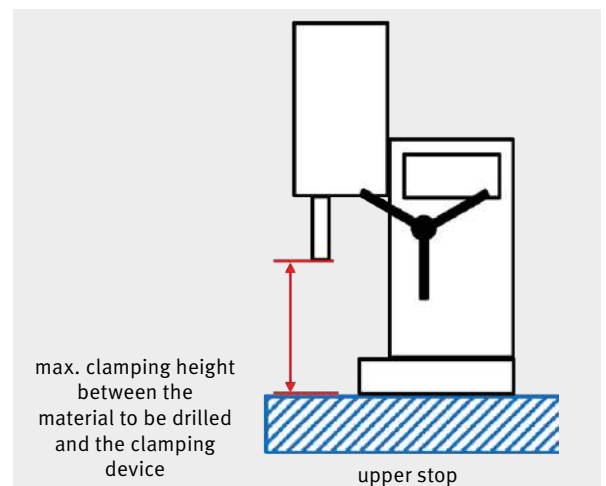

Metal-cutting band saws

Magnetic drilling machine adapters

Model	MB 202 G	MB 351	MB 502	
Art. no.	3862000	3860351	3860502	
Accessories used	<p>Core drill adapter (19 mm) (included with delivery)</p>  <p>Chuck adapter (included in scope of delivery)</p>  <p>Thread tapping adapter (included in scope of delivery)</p> 	<p>Quick-release chuck for core drill bit M 24 (Art. no.: 3877351)</p>  <p>Chuck 1.5 - 13 mm (Art.-No. 3876002)</p>  <p>Chuck adapter 1/2" x 15 OT (Art. no.: 3876001)</p> 	<p>Quick-release chuck for core drill bit M 24 (Art.-Nr. 3877502)</p>  <p>Chuck 1 - 16 mm (Art. no.: 3876005)</p>  <p>Chuck adapter 5/8" x 15 OT (Art. no. 3876004)</p> 	
Without adapter	Upper stop – lower stop = stroke length	205 mm – 58 mm = 147 mm	191 mm – 85 mm = 106 mm	245 mm – 120 mm = 125 mm
max. clamping height between the material to be drilled andcore drill adapter (19 mm)	145 mm	–	–
	...core drill adapter (32 mm)	–	–	–
	...quick release core drill adapter (19 mm)	–	63 mm	82 mm
	...Chuck adapter (jaws retracted/extended)	120 mm / 110 mm	–	–
	...Chuck adapter 13 mm (jaws retracted/extended)	–	120 mm / 107 mm	–
...Chuck adapter 16 mm (jaws retracted/extended)	–	–	121 mm / 105 mm	
...Thread tapping adapter	149 mm	–	–	

Please note that the drilling depths can vary depending on the adapters and drill bits used!



Model	MB 502 E	MB 754	MB 1204
Art. no.	3860500	3860754	3861204
Accessories used			
	Chuck 1.5 - 13 mm (Art.-No. 3876002) 	Chuck 1 - 16 mm (Art. no.: 3876005) 	Chuck 1 - 16 mm (Art. no.: 3876005) 
	Chuck adapter (Art.-No. 3876020) 	Chuck adapter MK 3 (Art. no.: 3876007) 	Chuck adapter MK 3 (Art. no.: 3876007) 
		Thread tapping chuck 19 mm (Art. 3876017) 31 mm (Art. no. 3876018) 	
		Quick change inserts M5 - M25 (Art. no. 3876009-16) 	
Without adapter	Upper stop – lower stop = stroke length	110 mm (variable drilling head adjustment)	210 mm – 55 mm = 155 mm
max. clamping height between the material to be drilled andcore drill adapter (19 mm)	–	90 mm
	...core drill adapter (32 mm)	–	–
	...quick release core drill adapter (19 mm)	225 mm	–
	...Chuck adapter (jaws retracted/extended)	–	–
	...Chuck adapter 13 mm (jaws retracted/extended)	160 mm / 147 mm	–
	...Chuck adapter 16 mm (jaws retracted/extended)	–	108 mm / 92 mm
...Thread tapping adapter	–	–	116 mm / 102 mm

Please note that the drilling depths can vary depending on the adapters and drill bits used!

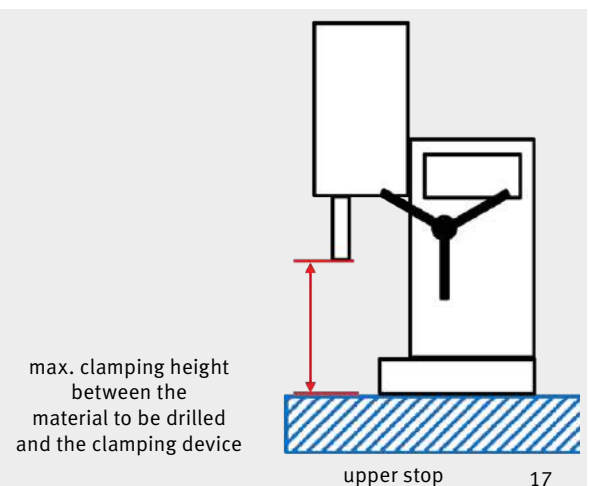

Magnetic drilling machines

Accessories for Metallkraft magnetic drilling machines

Accessories MB 351

Chuck adapter	
	Art. no.
Thread: 1/2" x 15 OT Shaft length: 27 mm Shank Ø 35 mm Chuck: M 24	3876001

Chuck · Including chuck key	
	Art. no.
1.5 - 13 mm	3876002

Quick-release chuck for core drill bit · Compatible with all core drill bit models in the Metallkraft main catalogue	
	Art. no.
M 24, short shank	3877351

Accessories MB 502

Chuck adapter	
	Art. no.
Thread: 5/8" x 15 OT Shaft length: 61 mm Shank Ø 35 mm Chuck: M 24	3876004

Chuck · Including chuck key	
	Art. no.
1 - 16 mm	3876005

Quick-release chuck for core drill bit · Compatible with all core drill bit models in the Metallkraft main catalogue	
	Art. no.
M 24, long shank	3877502

Accessories MB 754

Chuck adapter	
	Art. no.
MK 3	3876007

Chuck · Including chuck key	
	Art. no.
1 - 16 mm	3876005

Thread tapping chuck		
		
Morse cone	Chuck Ø	Art. no.
MK 3	19 mm	3876017
MK 3	31 mm	3876018

Accessories MB 502 E

Chuck adapter	
	Art. no.
Weldon 19 mm to 1/2" x 20 OT	3876020

Chuck · Including chuck key	
	Art. no.
1.5 - 13 mm	3876002

Quick change inserts		
		
Thread DIN376	Shank Ø	Art. no.
M5	19 mm	3876009
M6	19 mm	3876010
M8	31 mm	3876011
M10	31 mm	3876012
M12	31 mm	3876013
M16	31 mm	3876014
M20	31 mm	3876015
M25	31 mm	3876016



Core-drill set 6-part
in a practical plastic case
(Ø 12, 14, 16, 18, 20, 22 mm
Length: 25 mm)

Art no. 3873008

Now with 18 mm BLUE-LINE drill bit!



Test a core drill bit with universal chuck in our premium quality line **BLUE-LINE** with patented **Durablue coating** for extreme surface hardness and smoothness. For maximum service life also in dry drilling.

Chipmag swarf remover

For removing magnetic metal chips
For cleaning, e.g. the core drill inside surfaces
and collecting magnetic small parts
Art no. 3850010,



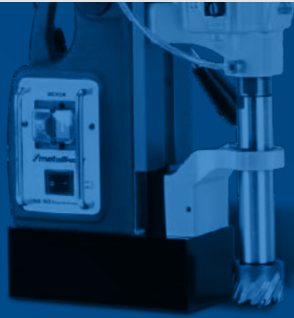

Product info Core bit qualities



Made of high-alloyed HSS-XE special steel. For extreme hardness at the tip of the tooth (up to 68 HRC). And thus for a long service life.



Made of ASP powder steel for drilling of difficult materials like railway tracks, stainless steels and exotic alloys. Deployable wherever maximum service life is needed.



Only a few manufacturers are capable of producing hardened HSS core drills. For Karnasch this is "standard". Only this helps us produce extremely hard tooth tips (68 HRC) but with a flexible core drill.

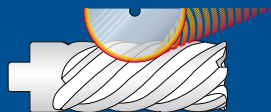

HSS-XE/ASP core drill bits ground from solid material. This finish increases the cutting ability while reducing friction at the same time. For a longer service life.

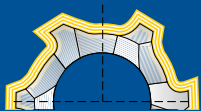

Gold-Tech surface treatment. The special treatment for a longer service life.

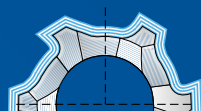

Our premium HSS-XE/ASP core drills + solid drills feature the unique and patented Durablue coating. Extreme surface hardness and smoothness guarantee an amazing service life even under less than optimum conditions like "overhead work", dry drilling, etc.

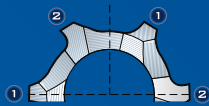

With HSS-XE/ASP core drills we are not happy with just one cutting edge geometry. Five geometries have been optimally adapted to the various diameters and cutting depths. You can always look forward to the perfect geometry.

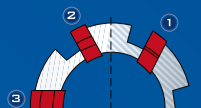

Karnasch carbide core drills (Hard-Line) are manufactured with an elaborate pre-/intermediate-/post-cutting geometry. This results in: low-vibration, quiet and easy cutting with longest service lives.

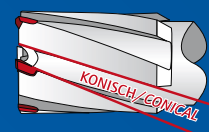

Karnasch carbide core drills (Hard-Line) are made with a conical helix for a clean chip flow and highest cutting ability even with difficult materials. (heavy duty cutting)



Karnasch carbide core drills (Hard-Line) are exclusively equipped with Sandvik carbide teeth. Our opinion is: Only the best carbide is good enough for Karnasch core drills.



SILVER-LINE



GOLD-LINE



BLUE-LINE



BLUE-LINE PRO



HARD-LINE

✓	✓	✓		
			✓	
✓	✓	✓	✓	
	✓	✓	✓	
	✓			
		✓	✓	
✓	✓	✓	✓	
				✓
				✓
				✓





Core bits

Variant	Ø	Applications
 <p>Ø 12 - 150 mm</p> <p>40, 55, 80, 110 mm Cutting depths</p> <p>HARD-LINE</p> <p>Carbide-tipped core drills The best performing core drill in our product range excellent for all steels up to 1400 N strength, and for all stainless steels.</p>		 Steel  stainless steel  Grey cast iron  Alu  Copper, brass, Tin
	<p>< 1 400 N > 900 N > 10% Si</p> <p>✓ ✓ ✓ ✓ ✓</p>	











Variant	Ø	Applications
 <p>Ø 12 - 36 mm</p> <p>30, 55 mm Cutting depths</p> <p>BLUE-LINE PRO</p> <p>Powder steel core drills with DURABLU coating. For the most difficult cutting tasks. Good for all steels up to 1 400 N strength, and for all stainless steels.</p>		 Steel  stainless steel  Grey cast iron  Alu  Copper, brass, Tin
	<p>< 1 400 N > 900 N > 10% Si</p> <p>✓ ✓ ✓ ✓ ✓</p>	

Variant	Ø	Applications
 <p>Ø 12 - 60 mm</p> <p>30, 55, 80, 110 mm Cutting depths</p> <p>BLUE-LINE</p> <p>Core drills made of HSS-XE special steel with DURABLU coating. The most popular coated core drill for all steels up to 1 100 N strength, and for all stainless steels.</p>		 Steel  stainless steel  Grey cast iron  Alu  Copper, brass, Tin
	<p>< 1 400 N > 900 N > 10% Si</p> <p>✓ ✓ ✓ ✓ ✓</p>	

Variant	Ø	Applications
 <p>Ø 12 - 60 mm</p> <p>30, 55, 80, 110 mm Cutting depths</p> <p>GOLD-LINE</p> <p>Core drills made of HSS-XE special steel with GOLD TECH treatment. The most popular non-coated core drill for all steels up to 900 N strength. Also suitable for stainless steel.</p>		 Steel  stainless steel  Alu
	<p>< 1 400 N > 900 N > 10% Si</p> <p>✓ ✓ ✓</p>	

Variant	Ø	Applications
 <p>Ø 12 - 60 mm</p> <p>25, 50 mm Cutting depths</p> <p>SILVER-LINE</p> <p>Core drills made of HSS-XE special steel with 7 different cutting geometries. For all steels up to 750 N strength.</p>		 Steel  Alu  Copper, brass, Tin
	<p>< 750 N > 10% Si</p> <p>✓ ✓ ✓</p>	

Feed mm/rev.

	Feed for HSS-XE/ASP Core drill: Silver-Line, Gold-Line, Blue-Line, Blue-Line Pro	Feed guide values for HM core drills: Hard-Line
 Steel < 500 N	0.15	0.10
 Steel < 750 N	0.18	0.10
 Steel < 900 N	0.16	0.10-0.12
 Steel < 1 200 N	0.16	0.10-0.15
 Steel < 1 400 N	0.17	0.16
 stainless steel	0.10	0.13
 Aluminium	0.25	0.24
 Grey cast iron	0.16	0.08-0.13
 Bronze	0.18	0.12
 Copper	0.21	0.12

Grey cast iron cutting cooling: dry/compressed air
Cutting oil is recommended for all other materials!

Instructions for use:

- Centre punching for core drills. For core drills with a diameter of 12-15 mm it is absolutely necessary to create a strong centre mark. Make sure that the tip of the ejector pin is positioned exactly in the middle of the centre mark. Highly recommendable also for all other diameters.
- Speeds for core drills. For HSS core bits 12 - 15 mm, a minimum speed of 450 rpm must be adhered to. For HM core bits, a minimum of approx. 600 rpm would be optimal. If this is not possible, you will need to work at half the recommended feed speed.
- Feed. Always initially drill slowly and carefully to a depth of 1 mm. You can then continue at the normal feed speed. Please take this advice to heart. It will significantly extend the drill's service life.
- Drilling. It may be necessary to repeatedly ventilate the drill depending on the chip flow. This applies in particular to cutting depths as of approx. 25 mm. If you feel more pronounced resistance or vibrations, please immediately proceed as follows:
 - Exit the borehole while drill is turning.
 - Clean the swarf off the drill and hole (e.g., with a blowgun)
 - Fill the hole with cooling and lubricating emulsion.
 - Insert the drill into the hole again while it is rotating. Do not change the position of the machine or the workpiece during the entire process.
 - This procedure may need to be repeated depending on the chip flow and drilling depth.
- Cooling. Use only high-performance cutting oils. As of approx. 35mm Ø only use Morse taper seats with automatic internal cooling.

Speeds

Speeds for HSS-XE/ASP core drills
Silver-Line, Gold-Line, Blue-Line, Blue-Line Pro



Ø	mm Inches	12-18	19-25	26-32	33-39	40-46	47-53	54-60	61-70	71-80	81-90	91-100	101-112	113-124	125-136	137-150
		7/16" - 11/16"	3/4" - 1"	1 1/16" - 1 1/4"	1 5/16" - 1 9/16"	1 5/8" - 1 13/16"	1 7/8" - 2 1/16"	2 1/8" - 2 3/8"	2 13/32" - 2 3/4"	2 51/64" - 3 5/32"	3 3/16" - 3 9/16"	3 19/32" - 3 15/16"	3 31/32" - 4 13/32"	4 15/32" - 4 7/8"	4 15/16" - 5 11/32"	5 13/32" - 5 29/32"
	Steel < 500 N	660	420	305	240	195	165	145	125	110	95	85	75	68	63	57
		440	320	250	200	170	150	130	115	100	90	80	70	65	58	50
	Steel < 750 N	530	340	245	195	160	135	115	163	87	77	68	62	55	50	45
		350	250	200	165	140	120	105	90	78	70	63	56	51	46	42
	Steel < 900 N	340	250	185	145	120	100	88	78	67	58	52	47	41	38	34
		265	190	150	125	105	90	80	68	59	53	48	42	39	35	31
	Steel < 1 200 N	265	165	125	95	79	67	58	52	44	39	34	31	27	25	22
		175	130	100	80	70	60	53	45	40	35	32	28	26	23	21
	Steel < 1 400 N	185	117	85	67	55	47	41	36	30	26	23	21	18	16	16
		125	90	70	57	48	42	37	31	27	24	22	19	17		14
	stainless steel	320	200	145	115	90	80	70	62	53	46	41	37	32	29	27
		210	150	120	95	85	72	63	54	47	42	38	33	30	28	25
	Aluminium	980	620	455	360	295	250	220	193	165	145	129	116	104	94	85
		655	470	370	305	255	225	195	170	150	130	117	105	95	86	78
	Grey cast iron	480	300	200	175	143	122	106	93	80	70	62	56	50	45	41
		320	230	180	147	125	108	95	81	71	63	57	51	46	42	38
	Bronze	660	420	305	240	195	165	145	125	110	95	85	75	68	63	57
		440	320	250	200	170	150	130	115	100	90	80	70	65	58	50
	Copper	1060	670	490	390	320	270	235	205	178	157	138	127	110	100	90
		700	510	400	330	280	240	210	180	160	140	130	115	105	95	85

Rotational speed guide values for HM core bits
Hard-Line



Ø	mm Inches	12-18	19-25	26-32	33-39	40-46	47-53	54-60	61-70	71-80	81-90	91-100	101-112	113-124	125-136	137-150
		7/16" - 11/16"	3/4" - 1"	1 1/16" - 1 1/4"	1 5/16" - 1 9/16"	1 5/8" - 1 13/16"	1 7/8" - 2 1/16"	2 1/8" - 2 3/8"	2 13/32" - 2 3/4"	2 51/64" - 3 5/32"	3 3/16" - 3 9/16"	3 19/32" - 3 15/16"	3 31/32" - 4 13/32"	4 15/32" - 4 7/8"	4 15/16" - 5 11/32"	5 13/32" - 5 29/32"
	Steel < 500 N	1060	670	490	390	320	270	235	205	178	157	138	127	110	100	90
		700	510	400	330	280	240	210	180	160	140	130	115	105	95	85
	Steel < 750 N	980	620	450	360	295	250	220	193	165	145	129	115	104	94	85
		655	470	370	300	260	225	195	170	150	130	120	105	95	87	78
	Steel < 900 N	930	590	430	335	280	239	205	182	155	137	122	108	98	89	80
		620	450	340	285	240	210	185	160	140	125	110	100	90	81	75
	Steel < 1 200 N	795	500	370	290	240	200	175	155	135	117	104	94	84	76	69
		530	380	300	245	265	180	160	135	120	105	95	85	77	70	63
	Steel < 1 400 N	660	420	305	240	195	165	145	125	110	95	85	75	68	63	57
		440	320	250	200	170	150	130	115	100	90	80	70	65	58	50
	stainless steel	530	340	245	195	160	135	115	103	87	77	68	62	55	56	45
		350	250	200	165	140	120	105	90	78	70	63	56	51	46	42
	Aluminium	2390	1510	1100	870	715	610	530	470	405	355	315	283	253	229	209
		1 590	1150	895	735	625	540	480	410	360	320	285	255	230	210	190
	Grey cast iron	930	590	430	335	280	239	205	182	155	137	122	108	98	89	80
		620	450	340	285	240	210	185	160	140	125	110	100	90	81	75
	Bronze	1325	840	615	490	400	340	295	260	225	195	174	157	140	127	116
		885	635	500	410	345	300	265	230	200	175	160	145	130	117	105
	Copper	930	590	430	335	280	239	205	182	155	137	122	108	98	89	80
		620	450	340	285	240	210	185	160	140	125	110	100	90	81	75

Magnetic drilling

Deburring

Metal grinding

Cutting

Notching & punching

Bending

Presses

Circular saws

Roller conveyors

Metal-cutting band saws

Core bits

**SILVER-
LINE**

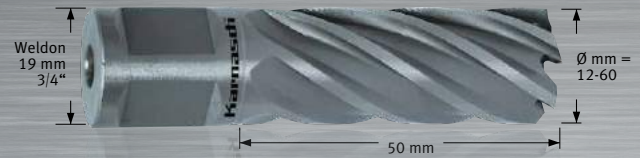
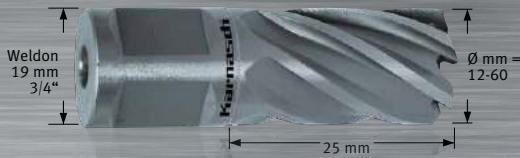

Ø mm	38720.1255		Ø mm	38720.1255	
12	38720.1255 12		37	38720.1255 37	
13	38720.1255 13		38	38720.1255 38	
14	38720.1255 14		39	38720.1255 39	
15	38720.1255 15		40	38720.1255 40	
16	38720.1255 16		41	38720.1255 41	
17	38720.1255 17		42	38720.1255 42	
18	38720.1255 18		43	38720.1255 43	
19	38720.1255 19		44	38720.1255 44	
20	38720.1255 20		45	38720.1255 45	
21	38720.1255 21		46	38720.1255 46	
22	38720.1255 22		47	38720.1255 47	
23	38720.1255 23		48	38720.1255 48	
24	38720.1255 24		49	38720.1255 49	
25	38720.1255 25		50	38720.1255 50	
26	38720.1255 26		51	38720.1255 51	
27	38720.1255 27		52	38720.1255 52	
28	38720.1255 28		53	38720.1255 53	
29	38720.1255 29		54	38720.1255 54	
30	38720.1255 30		55	38720.1255 55	
31	38720.1255 31		56	38720.1255 56	
32	38720.1255 32		57	38720.1255 57	
33	38720.1255 33		58	38720.1255 58	
34	38720.1255 34		59	38720.1255 59	
35	38720.1255 35		60	38720.1255 60	
36	38720.1255 36				

Ejector pin



38720.1261

Ø mm	38720.1265		Ø mm	38720.1265	
12	38720.1265 12		37	38720.1265 37	
13	38720.1265 13		38	38720.1265 38	
14	38720.1265 14		39	38720.1265 39	
15	38720.1265 15		40	38720.1265 40	
16	38720.1265 16		41	38720.1265 41	
17	38720.1265 17		42	38720.1265 42	
18	38720.1265 18		43	38720.1265 43	
19	38720.1265 19		44	38720.1265 44	
20	38720.1265 20		45	38720.1265 45	
21	38720.1265 21		46	38720.1265 46	
22	38720.1265 22		47	38720.1265 47	
23	38720.1265 23		48	38720.1265 48	
24	38720.1265 24		49	38720.1265 49	
25	38720.1265 25		50	38720.1265 50	
26	38720.1265 26		51	38720.1265 51	
27	38720.1265 27		52	38720.1265 52	
28	38720.1265 28		53	38720.1265 53	
29	38720.1265 29		54	38720.1265 54	
30	38720.1265 30		55	38720.1265 55	
31	38720.1265 31		56	38720.1265 56	
32	38720.1265 32		57	38720.1265 57	
33	38720.1265 33		58	38720.1265 58	
34	38720.1265 34		59	38720.1265 59	
35	38720.1265 35		60	38720.1265 60	
36	38720.1265 36				

Ejector pin

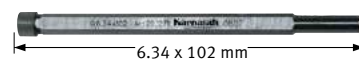

38720.1271

SILVER-LINE SET 25



Contents	Ø mm	
	14, 16, 18, 20, 22, 26	38720.1474
+ 2 ejector pins		

SILVER-LINE SET 50



Contents	Ø mm	
	14, 16, 18, 20, 22, 26	38720.1475
+ 2 ejector pins		

**Suitable
for core drilling
machines**

Metallkraft, Alfa-Rotabest + Alfa Rota-Quick, BDS + BDS Keyless, Bektop, Bux, Euroboor, Evolution, Hougen, Jancy, Magbroach, Magtron, Magnetor, Promag, Rotabroach, Ruko + Ruko Easy Lock, Universal...

GOLD-LINE

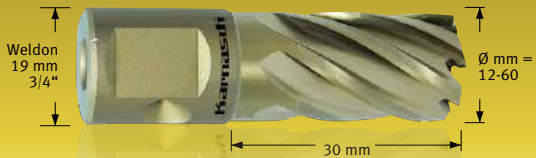

Ø mm	38720.1260U	Ø mm	38720.1260U
12	38720.1260U 12	37	38720.1260U 37
13	38720.1260U 13	38	38720.1260U 38
14	38720.1260U 14	39	38720.1260U 39
15	38720.1260U 15	40	38720.1260U 40
16	38720.1260U 16	41	38720.1260U 41
17	38720.1260U 17	42	38720.1260U 42
18	38720.1260U 18	43	38720.1260U 43
19	38720.1260U 19	44	38720.1260U 44
20	38720.1260U 20	45	38720.1260U 45
21	38720.1260U 21	46	38720.1260U 46
22	38720.1260U 22	47	38720.1260U 47
23	38720.1260U 23	48	38720.1260U 48
24	38720.1260U 24	49	38720.1260U 49
25	38720.1260U 25	50	38720.1260U 50
26	38720.1260U 26	51	38720.1260U 51
27	38720.1260U 27	52	38720.1260U 52
28	38720.1260U 28	53	38720.1260U 53
29	38720.1260U 29	54	38720.1260U 54
30	38720.1260U 30	55	38720.1260U 55
31	38720.1260U 31	56	38720.1260U 56
32	38720.1260U 32	57	38720.1260U 57
33	38720.1260U 33	58	38720.1260U 58
34	38720.1260U 34	59	38720.1260U 59
35	38720.1260U 35	60	38720.1260U 60
36	38720.1260U 36		

Ø mm	38720.1270U	Ø mm	38720.1270U
12	38720.1270U 12	37	38720.1270U 37
13	38720.1270U 13	38	38720.1270U 38
14	38720.1270U 14	39	38720.1270U 39
15	38720.1270U 15	40	38720.1270U 40
16	38720.1270U 16	41	38720.1270U 41
17	38720.1270U 17	42	38720.1270U 42
18	38720.1270U 18	43	38720.1270U 43
19	38720.1270U 19	44	38720.1270U 44
20	38720.1270U 20	45	38720.1270U 45
21	38720.1270U 21	46	38720.1270U 46
22	38720.1270U 22	47	38720.1270U 47
23	38720.1270U 23	48	38720.1270U 48
24	38720.1270U 24	49	38720.1270U 49
25	38720.1270U 25	50	38720.1270U 50
26	38720.1270U 26	51	38720.1270U 51
27	38720.1270U 27	52	38720.1270U 52
28	38720.1270U 28	53	38720.1270U 53
29	38720.1270U 29	54	38720.1270U 54
30	38720.1270U 30	55	38720.1270U 55
31	38720.1270U 31	56	38720.1270U 56
32	38720.1270U 32	57	38720.1270U 57
33	38720.1270U 33	58	38720.1270U 58
34	38720.1270U 34	59	38720.1270U 59
35	38720.1270U 35	60	38720.1270U 60
36	38720.1270U 36		

Ejector pin



38720.1261

Ejector pin

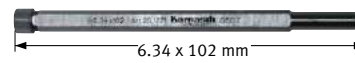

38720.1271

GOLD-LINE SET 30



Contents	Ø mm	
	14, 16, 18, 20, 22, 26	38720.1322
+ 2 ejector pins		

GOLD-LINE SET 55



Contents	Ø mm	
	14, 16, 18, 20, 22, 26	38720.1332
+ 2 ejector pins		

Core bits

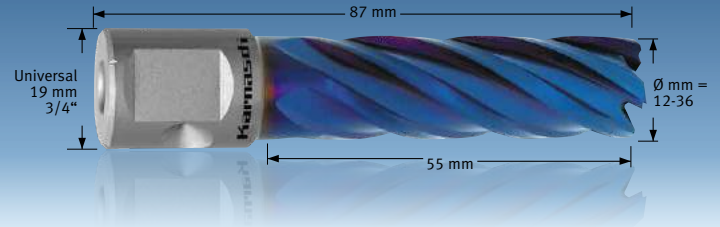
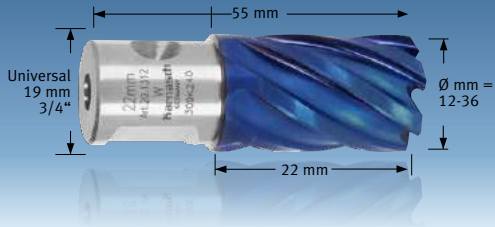

Ø mm	38720.1312	Ø mm	38720.1312
12	38720.1312 12	37	38720.1312 37
13	38720.1312 13	38	38720.1312 38
14	38720.1312 14	39	38720.1312 39
15	38720.1312 15	40	38720.1312 40
16	38720.1312 16	41	38720.1312 41
17	38720.1312 17	42	38720.1312 42
18	38720.1312 18	43	38720.1312 43
19	38720.1312 19	44	38720.1312 44
20	38720.1312 20	45	38720.1312 45
21	38720.1312 21	46	38720.1312 46
22	38720.1312 22	47	38720.1312 47
23	38720.1312 23	48	38720.1312 48
24	38720.1312 24	49	38720.1312 49
25	38720.1312 25	50	38720.1312 50
26	38720.1312 26	51	38720.1312 51
27	38720.1312 27	52	38720.1312 52
28	38720.1312 28	53	38720.1312 53
29	38720.1312 29	54	38720.1312 54
30	38720.1312 30	55	38720.1312 55
31	38720.1312 31	56	38720.1312 56
32	38720.1312 32	57	38720.1312 57
33	38720.1312 33	58	38720.1312 58
34	38720.1312 34	59	38720.1312 59
35	38720.1312 35	60	38720.1312 60
36	38720.1312 36		

Ø mm	38720.1313	Ø mm	38720.1313
12	38720.1313 12	37	38720.1313 37
13	38720.1313 13	38	38720.1313 38
14	38720.1313 14	39	38720.1313 39
15	38720.1313 15	40	38720.1313 40
16	38720.1313 16	41	38720.1313 41
17	38720.1313 17	42	38720.1313 42
18	38720.1313 18	43	38720.1313 43
19	38720.1313 19	44	38720.1313 44
20	38720.1313 20	45	38720.1313 45
21	38720.1313 21	46	38720.1313 46
22	38720.1313 22	47	38720.1313 47
23	38720.1313 23	48	38720.1313 48
24	38720.1313 24	49	38720.1313 49
25	38720.1313 25	50	38720.1313 50
26	38720.1313 26	51	38720.1313 51
27	38720.1313 27	52	38720.1313 52
28	38720.1313 28	53	38720.1313 53
29	38720.1313 29	54	38720.1313 54
30	38720.1313 30	55	38720.1313 55
31	38720.1313 31	56	38720.1313 56
32	38720.1313 32	57	38720.1313 57
33	38720.1313 33	58	38720.1313 58
34	38720.1313 34	59	38720.1313 59
35	38720.1313 35	60	38720.1313 60
36	38720.1313 36		

Ejector pin

38720.1261

Ejector pin

38720.1271

BLUE-LINE SET 30

Contents	Ø mm 14, 16, 18, 20, 22, 26	38720.1325
+ 2 ejector pins		

BLUE-LINE SET 55

Contents	Ø mm 14, 16, 18, 20, 22, 26	38720.1328
+ 2 ejector pins		

Suitable
for core drilling
machines

Metallkraft, Alfa-Rotabest + Alfa Rota-Quick, BDS + BDS Keyless,
Bektop, Bux, Euroboor, Evolution, Hougen, Jancy, Magbroach, Magtron,
Magnetor, Promag, Rotabroach, Ruko + Ruko Easy Lock, Universal...

**BLUE-
LINE
PRO**

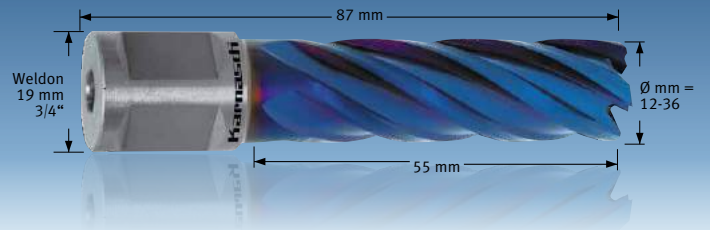
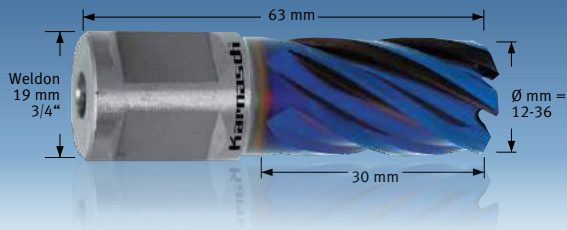

Ø mm	38720.1284		Ø mm	38720.1284	
12	38720.1284 12		25	38720.1284 25	
13	38720.1284 13		26	38720.1284 26	
14	38720.1284 14		27	38720.1284 27	
15	38720.1284 15		28	38720.1284 28	
16	38720.1284 16		29	38720.1284 29	
17	38720.1284 17		30	38720.1284 30	
18	38720.1284 18		31	38720.1284 31	
19	38720.1284 19		32	38720.1284 32	
20	38720.1284 20		33	38720.1284 33	
21	38720.1284 21		34	38720.1284 34	
22	38720.1284 22		35	38720.1284 35	
23	38720.1284 23		36	38720.1284 36	
24	38720.1284 24				

Ø mm	38720.1317		Ø mm	38720.1317	
12	38720.1317 12		25	38720.1317 25	
13	38720.1317 13		26	38720.1317 26	
14	38720.1317 14		27	38720.1317 27	
15	38720.1317 15		28	38720.1317 28	
16	38720.1317 16		29	38720.1317 29	
17	38720.1317 17		30	38720.1317 30	
18	38720.1317 18		31	38720.1317 31	
19	38720.1317 19		32	38720.1317 32	
20	38720.1317 20		33	38720.1317 33	
21	38720.1317 21		34	38720.1317 34	
22	38720.1317 22		35	38720.1317 35	
23	38720.1317 23		36	38720.1317 36	
24	38720.1317 24				

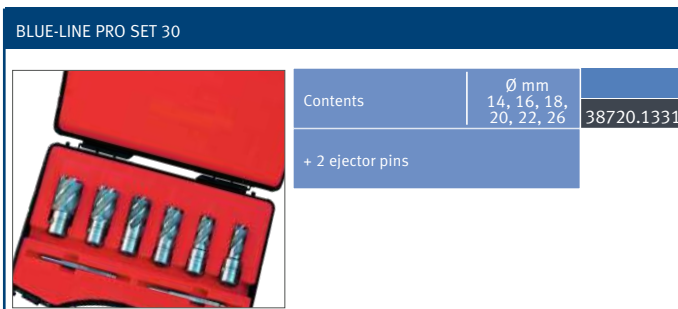

Suitable
for core drilling
machines

Metalkraft, Alfa-Rotabest + Alfa Rota-Quick, BDS + BDS Keyless, Bektop, Bux, Euroboor, Evolution, Hougen, Jancy, Magbroach, Magtron, Magnetor, Promag, Rotabroach, Ruko + Ruko Easy Lock, Universal...

Core bits

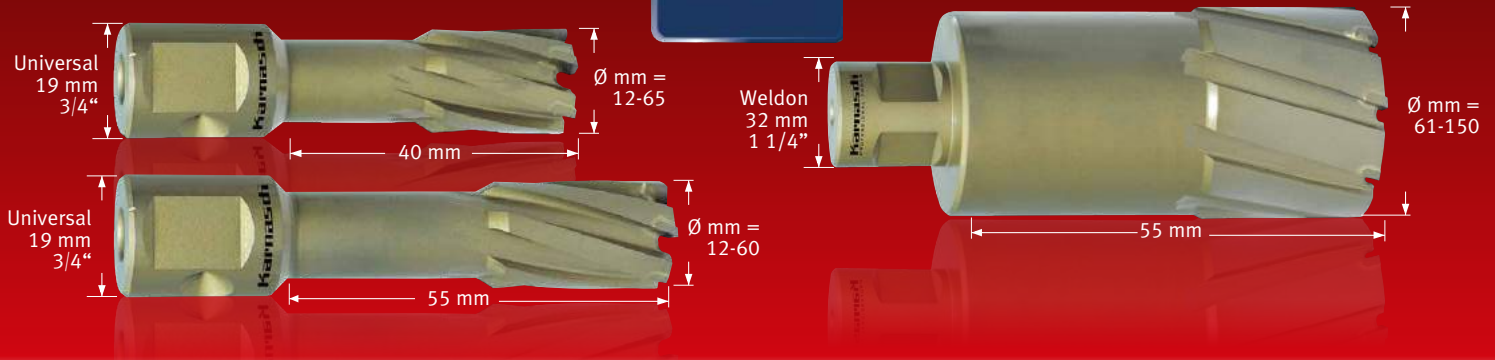

Ø mm	38720.1315	Ø mm	38720.1315	Ø mm	38720.1315	Ø mm	38720.1316	Ø mm	38720.1316	Ø mm	38720.1316
12	38720.1315 12	38	38720.1315 38	64	38720.1315 64	12	38720.1316 12	41	38720.1316 41	74	38720.1316 74
13	38720.1315 13	39	38720.1315 39	65	38720.1315 65	13	38720.1316 13	42	38720.1316 42	75	38720.1316 75
14	38720.1315 14	40	38720.1315 40	66*	38720.1315 66	14	38720.1316 14	43	38720.1316 43	76	38720.1316 76
15	38720.1315 15	41	38720.1315 41	67*	38720.1315 67	15	38720.1316 15	44	38720.1316 44	77	38720.1316 77
16	38720.1315 16	42	38720.1315 42	68*	38720.1315 68	16	38720.1316 16	45	38720.1316 45	78	38720.1316 78
17	38720.1315 17	43	38720.1315 43	69*	38720.1315 69	17	38720.1316 17	46	38720.1316 46	79	38720.1316 79
18	38720.1315 18	44	38720.1315 44	70*	38720.1315 70	17.5	38720.1316 17,5	47	38720.1316 47	80	38720.1316 80
19	38720.1315 19	45	38720.1315 45	71*	38720.1315 71	18	38720.1316 18	48	38720.1316 48	82	38720.1316 82
20	38720.1315 20	46	38720.1315 46	72*	38720.1315 72	19	38720.1316 19	49	38720.1316 49	83	38720.1316 83
21	38720.1315 21	47	38720.1315 47	73*	38720.1315 73	20	38720.1316 20	50	38720.1316 50	84	38720.1316 84
22	38720.1315 22	48	38720.1315 48	74*	38720.1315 74	21	38720.1316 21	51	38720.1316 51	85	38720.1316 85
23	38720.1315 23	49	38720.1315 49	75*	38720.1315 75	21.5	38720.1316 21,5	52	38720.1316 52	88	38720.1316 88
24	38720.1315 24	50	38720.1315 50	76*	38720.1315 76	22	38720.1316 22	53	38720.1316 53	90	38720.1316 90
25	38720.1315 25	51	38720.1315 51	77*	38720.1315 77	23	38720.1316 23	54	38720.1316 54	92	38720.1316 92
26	38720.1315 26	52	38720.1315 52	78*	38720.1315 78	23.5	38720.1316 23,5	55	38720.1316 55	95	38720.1316 95
27	38720.1315 27	53	38720.1315 53	79*	38720.1315 79	24	38720.1316 24	56	38720.1316 56	100	38720.1316 100
28	38720.1315 28	54	38720.1315 54	80*	38720.1315 80	25	38720.1316 25	57	38720.1316 57	103	38720.1316 103
29	38720.1315 29	55	38720.1315 55	85*	38720.1315 85	25.5	38720.1316 25,5	58	38720.1316 58	104	38720.1316 104
30	38720.1315 30	56	38720.1315 56	90*	38720.1315 90	26	38720.1316 26	59	38720.1316 59	105	38720.1316 105
31	38720.1315 31	57	38720.1315 57	95*	38720.1315 95	27	38720.1316 27	60	38720.1316 60	106	38720.1316 106
32	38720.1315 32	58	38720.1315 58	100*	38720.1315 100	28	38720.1316 28	61	38720.1316 61	108	38720.1316 108
33	38720.1315 33	59	38720.1315 59	105*	38720.1315 105	29	38720.1316 29	62	38720.1316 62	110	38720.1316 110
34	38720.1315 34	60	38720.1315 60	110*	38720.1315 110	30	38720.1316 30	63	38720.1316 63	115	38720.1316 115
35	38720.1315 35	61	38720.1315 61	115*	38720.1315 115	31	38720.1316 31	64	38720.1316 64	120	38720.1316 120
36	38720.1315 36	62	38720.1315 62	120*	38720.1315 120	32	38720.1316 32	65	38720.1316 65	125	38720.1316 125
37	38720.1315 37	63	38720.1315 63			33	38720.1316 33	66	38720.1316 66	130	38720.1316 130
						34	38720.1316 34	67	38720.1316 67	135	38720.1316 135
						35	38720.1316 35	68	38720.1316 68	140	38720.1316 140
						36	38720.1316 36	69	38720.1316 69	145	38720.1316 145
						37	38720.1316 37	70	38720.1316 70	150	38720.1316 150
						38	38720.1316 38	71	38720.1316 71		
						39	38720.1316 39	72	38720.1316 72		
						40	38720.1316 40	73	38720.1316 73		

* as of Ø 66 mm the Weldon 32 mm seat is required

Ejector pin

	Ø 12-17 mm	38720.1149
	Ø 18-65 mm	38720.1151
	Ø 66-120 mm	38720.1273

Ejector pin

	Ø 12-17 mm	38720.1271
	Ø 18-60 mm	38720.1273
	Ø 61-150 mm	38720.1272

HARD-LINE SET 40

	Contents	Ø mm 14, 16, 18, 20, 22, 26	38720.1336
	+ 2 ejector pins		

HARD-LINE SET 55

	Contents	Ø mm 14, 16, 18, 20, 22, 26	38720.1339
	+ 2 ejector pins		

Suitable for core drilling machines
 Metallkraft, Alfa-Rotabest + Alfa Rota-Quick, BDS + BDS Keyless, Bektop, Bux, Euroboor, Evolution, Hougen, Jancy, Magbroach, Magtron, Magnetor, Promag, Rotabroach, Ruko + Ruko Easy Lock, Universal...

HARD-LINE

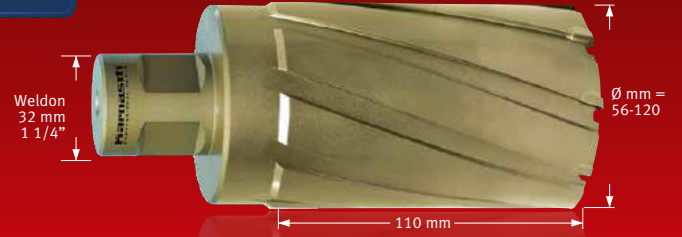
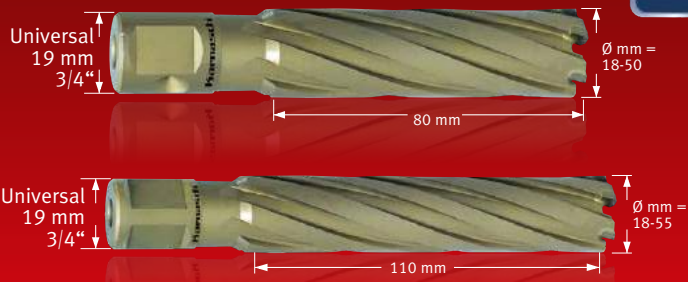

Ø mm	38720.1650	Ø mm	38720.1650	Ø mm	38720.1650	Ø mm	38720.1660	Ø mm	38720.1660	Ø mm	38720.1660
18	38720.1650 18	43	38720.1650 43	68	38720.1650 68	18	38720.1660 18	43	38720.1660 43	68	38720.1660 68
19	38720.1650 19	44	38720.1650 44	69	38720.1650 69	19	38720.1660 19	44	38720.1660 44	69	38720.1660 69
20	38720.1650 20	45	38720.1650 45	70	38720.1650 70	20	38720.1660 20	45	38720.1660 45	70	38720.1660 70
21	38720.1650 21	46	38720.1650 46	72	38720.1650 72	21	38720.1660 21	46	38720.1660 46	72	38720.1660 72
22	38720.1650 22	47	38720.1650 47	73	38720.1650 73	22	38720.1660 22	47	38720.1660 47	73	38720.1660 73
23	38720.1650 23	48	38720.1650 48	74	38720.1650 74	23	38720.1660 23	48	38720.1660 48	74	38720.1660 74
24	38720.1650 24	49	38720.1650 49	75	38720.1650 75	24	38720.1660 24	49	38720.1660 49	75	38720.1660 75
25	38720.1650 25	50	38720.1650 50	76	38720.1650 76	25	38720.1660 25	50	38720.1660 50	76	38720.1660 76
26	38720.1650 26	51	38720.1650 51	78	38720.1650 78	26	38720.1660 26	51	38720.1660 51	78	38720.1660 78
27	38720.1650 27	52	38720.1650 52	80	38720.1650 80	27	38720.1660 27	52	38720.1660 52	80	38720.1660 80
28	38720.1650 28	53	38720.1650 53	82	38720.1650 82	28	38720.1660 28	53	38720.1660 53	82	38720.1660 82
29	38720.1650 29	54	38720.1650 54	85	38720.1650 85	29	38720.1660 29	54	38720.1660 54	85	38720.1660 85
30	38720.1650 30	55	38720.1650 55	90	38720.1650 90	30	38720.1660 30	55	38720.1660 55	90	38720.1660 90
31	38720.1650 31	56	38720.1650 56	95	38720.1650 95	31	38720.1660 31	56	38720.1660 56	95	38720.1660 95
32	38720.1650 32	57	38720.1650 57	100	38720.1650 100	32	38720.1660 32	57	38720.1660 57	100	38720.1660 100
33	38720.1650 33	58	38720.1650 58	103	38720.1650 103	33	38720.1660 33	58	38720.1660 58	103	38720.1660 103
34	38720.1650 34	59	38720.1650 59	104	38720.1650 104	34	38720.1660 34	59	38720.1660 59	104	38720.1660 104
35	38720.1650 35	60	38720.1650 60	105	38720.1650 105	35	38720.1660 35	60	38720.1660 60	105	38720.1660 105
36	38720.1650 36	61	38720.1650 61	106	38720.1650 106	36	38720.1660 36	61	38720.1660 61	106	38720.1660 106
37	38720.1650 37	62	38720.1650 62	108	38720.1650 108	37	38720.1660 37	62	38720.1660 62	108	38720.1660 108
38	38720.1650 38	63	38720.1650 63	110	38720.1650 110	38	38720.1660 38	63	38720.1660 63	110	38720.1660 110
39	38720.1650 39	64	38720.1650 64	115	38720.1650 115	39	38720.1660 39	64	38720.1660 64	115	38720.1660 115
40	38720.1650 40	65	38720.1650 65	120	38720.1650 120	40	38720.1660 40	65	38720.1660 65	120	38720.1660 120
41	38720.1650 41	66	38720.1650 66			41	38720.1660 41	66	38720.1660 66		
42	38720.1650 42	67	38720.1650 67			42	38720.1660 42	67	38720.1660 67		

Ejector pin, 2-piece



APPLICATION
Insert part 1 into the core drill shank.
Push part 2 onto part 1. Drill to a cutting depth of approx. 50 mm. Then remove part 2 and continue drilling.

Ejector pin, 1-piece



This one-piece ejector pin can be used in combination with adapter seat Art no. 38720.1291. Drilling depths up to 110 mm in a single work step without changing. Robust and simple.

Ejector pin, 2-piece

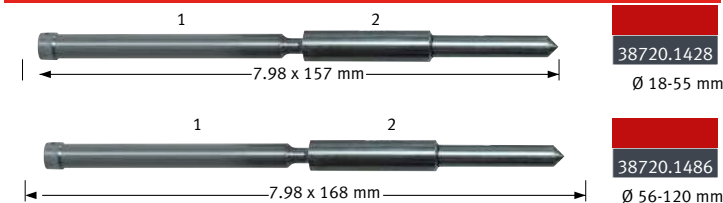

APPLICATION
Insert part 1 into the core drill shank.
Push part 2 onto part 1. Drill to a cutting depth of approx. 50 mm. Then remove part 2 and continue drilling.

Ejector pin



This one-piece ejector pin can be used in combination with adapter seat Art no. 38720.1291. Drilling depths up to 110 mm in a single work step without changing. Robust and simple.

Suitable for core drilling machines
Metalkraft, Alfra-Rotabest + Alfra Rota-Quick, BDS + BDS Keyless, Bektop, Bux, Euroboor, Evolution, Hougen, Jancy, Magbroach, Magtron, Magnetor, Promag, Rotabroach, Ruko + Ruko Easy Lock, Universal...

Magnetic drilling
Deburring
Metal grinding
Cutting
Notching & punching
Bending
Presses
Circular saws
Roller conveyors
Metal-cutting band saws

Seat holders core bits/lubricants

Seat holder



Quick-Change seat holder **with** automatic internal cooling. Suitable for all core drills with Weldon shank/universal shank 19 mm (3/4").

Seat holder **with** automatic internal cooling. Suitable for all core drills with Weldon shank/universal shank 19 mm (3/4").

Lubricants + cutting oil

Heavy-duty cutting oil "MECUTOIL 100". For mixing with water 5% oil = for normal construction steels as well as all NF metals, 10% oil = for steels of higher strength, incl. stainless steels. For difficult machining problems up to 50% oil can be admixed with water. Ideal oil for any machining work. For filling, e.g., into Karnasch cooling pressure cylinders

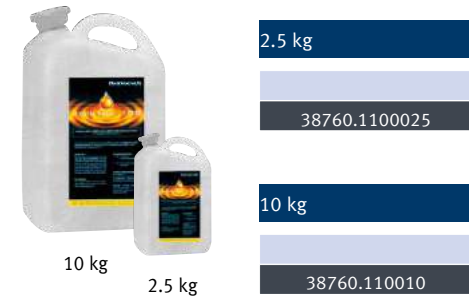

MORSE KONUS 2
Morse taper 2

Core drill change within seconds without any tools



38720.1303

MORSE KONUS 2
Morse taper 2



38720.1287

MORSE KONUS 3
Morse taper 3

Core drill change within seconds without any tools

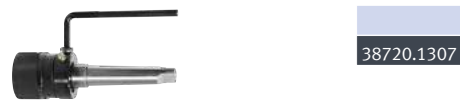

38720.1307

MORSE KONUS 3
Morse taper 3



38720.1289

Quick-Change seat holder **without** automatic internal cooling. Suitable for all core drills with Weldon shank/universal shank 19 mm (3/4") core bits.

Seat holder **with** automatic internal cooling. Suitable for all core drills with Weldon shank/universal shank 32 mm (1 1/4").

Heavy-duty cutting spray "MECUTSPRAY". Propellant-free thanks to manual pump mechanism. Content 500 ml. The ideal spray for machining work on all steel grades and non-ferrous metals. Biodegradable as per CC-L-33-T82.



MORSE KONUS 2
Morse taper 2

Core drill change within seconds without any tools



38720.1301

MORSE KONUS 3
Morse taper 3



38720.1290

MORSE KONUS 3
Morse taper 3

Core drill change within seconds without any tools



38720.1437

MORSE KONUS 4
Morse taper 4



38720.1292

MORSE KONUS 3
Morse taper 3

Extra long seat holder with automatic coolant supply especially for all extra long core drills such as the following series: Gold-Line 80+110, Blue-Line 80+110, Hard-Line 80+110 with universal shank 19 mm (3/4"). With this seat holder you don't need to change the two-piece ejector pins. You can drill as deep as 110 mm in a single work step.

Seat holder **without** automatic internal cooling. Suitable for all core drills with Weldon shank/universal shank 19 mm (3/4").

Universal cutting paste. Paste clings on the tool. Ideal for work under difficult conditions, e.g., overhead work. For machining work with various steel grades and non-ferrous metals. Free from chlorine.

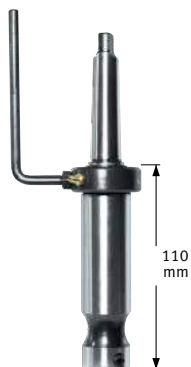

38720.1291

MORSE KONUS 2
Morse taper 2



38720.1283

Seat holder **without** automatic internal cooling. Suitable for all core drills with Weldon shank/universal shank 32 mm (1 1/4").

Special cutting wax: Especially for non-ferrous metals like aluminium, copper, brass. Wax sticks to the tool, making it ideal for, e.g., overhead work. Free from chlorine.



MORSE KONUS 3
Morse taper 3



38720.1286



38720.1293



Deburring



Deburring

KE 6-2 – Edge deburrer for radii, drill holes, inside and outside edges

- ▶ Ideal for creating clean visible edges
- ▶ Handy and powerful device
- ▶ Setting the chamfering height without tool
- ▶ For machining steel and aluminium
- ▶ For deburring radii and drill holes from 20 mm diameter
- ▶ With 3-fold turnover plate holder
- ▶ Manual feed
- ▶ Speed from 3 000 to 6 000 rpm continuously variable

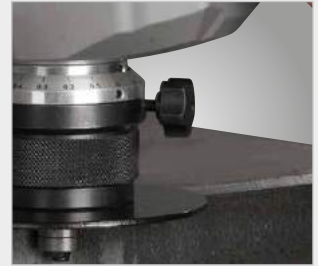

▶ For creating clean visible edges, e.g. on steel girders

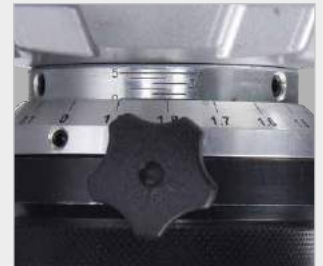

▶ Chamfer width from 0 to 6 mm continuously variable
▶ Convenient and exact setting of the chamfer width thanks to easy-to-read scale



▶ 3-fold turnover plate holder



KE 6-2 with mounted side handle

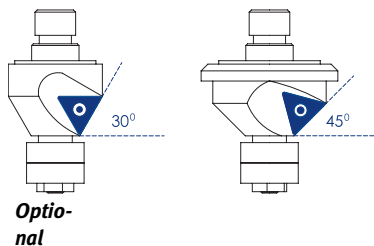

Model	KE 6-2
Art. no.	3990007

Technical specifications	
Chamfer angle	45° (optional 30°)
Chamfer width at 45°	0 - 6 mm
Electrical connection	230 V/50 Hz
Services	1 100 Watts
Speed (continuously variable)	3 000 - 6 000 rpm
Dimensions (L x W x H)	308 x 344 x 273 mm
Weight	4.7 kg

Scope of delivery:

- > Plastic case
- > 3-fold turnover plate holder 45°
- > 1x Cutting plate set consisting of three 4x indexing inserts
- > 1x Tool kit
- > 1x Side handle

Accessories KE 6-2		Art. no.
1	30° tool holder	3990020
2	45° tool holder	3990021
3	Cutting plate set (10 pcs.)	3990022
4	Guide roller 45°	3990023
5	Guide roller 30°	3990024

KE 10-2 – Edge deburrer for radii, drill holes, inside and outside edges, up to 10.6 mm chamfer width

- ▶ Ideal for ensuring clean visible edges and preparing welds
- ▶ Handy and powerful device
- ▶ Setting the chamfering height without tool
- ▶ For machining steel and aluminium
- ▶ For deburring radii and drill holes from 30 mm

- diameter
- ▶ With 6-fold turnover plate holder
 - ▶ Manual feed
 - ▶ Speed from 2,300 to 6,500 rpm continuously variable



▶ 6-fold turnover plate holder



- ▶ Chamfer width from 0 to 10.6 mm continuously variable
- ▶ Exact setting of the chamfer width thanks to easy-to-read scale
- ▶ 3 chamfer angles 30° / 37.5° / 45°



KE 10-2 with mounted handle

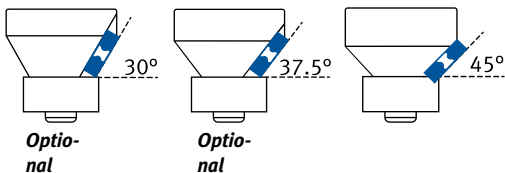

Model	KE 10-2
Art. no.	3990012

Technical specifications	
Chamfer angle	45° (optional 30° / 37.5°)
Chamfer width at 45°	0 - 10.6 mm
Electrical connection	230 V/50 Hz
Services	1 800 Watts
Speed (continuously variable)	2 300 - 6 500 rpm
Dimensions (L x W x H)	485 x 192 x 150 mm
Weight	6.5 kg

Scope of delivery:

- › Plastic case
- › 6-fold cutting plate holder 45°
- › 1x Cutting plate set consisting of 6 cutting plates
- › 1x Tool kit
- › 1x Front handle



Accessories KE 10-2

	Art. no.
1 Cutting plate set (6 pieces)	3991110
2 Milling head & guide roller 45°	3991111
3 Milling head & guide roller 30°	3991112
4 Milling head & guide roller 37.5°	3991113

Deburring

KE 100 – Edge deburrer for exterior edges, for mobile and stationary use

- ▶ For creating clean visible edges and preparing welds
- ▶ Device for stationary or mobile use
- ▶ Easy and quick change-over from stationary to mobile use with wing nuts and removable foot
- ▶ Tool-free setting of the chamfer depth
- ▶ Standard angle settings at 15°, 30° and 45°
- ▶ Manual feed
- ▶ Patented technology
- ▶ Handy and powerful device
- ▶ For machining steel, non-ferrous metals and plastics
- ▶ Functional arrangement of the handles allows for safe guiding of the device in mobile operation
- ▶ Guide plate equipped with adjustable ball heads for smooth running of the workpiece
- ▶ Automatic safety shutoff in case of overheating



Mobile use

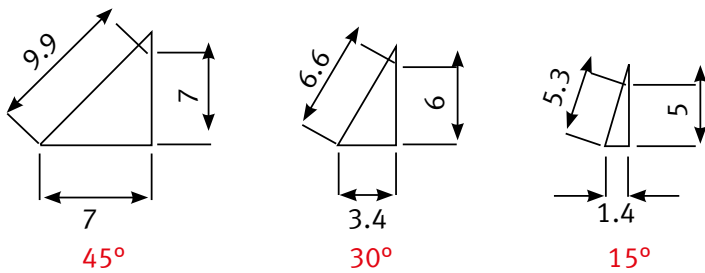

1



2



Model	KE 100
Art. no.	3992000

Technical specifications	
Chamfer angle	15° / 30° / 45°
Chamfer width at 15°	approx. 5 mm
Chamfer width at 30°	approx. 6 mm
Chamfer width at 45°	approx. 7 mm
Electrical connection	230 V
Services	750 W
Speed (continuously variable)	2 000 - 5 000 rpm
Dimensions (L x W x H max.)	360 x 230 x 280 mm
Weight	10.5 kg

Scope of delivery:

- › Edge deburring device KE 100
- › Milling head with cutting plates
- › 3 rubber feet
- › Workpiece slide

Accessories	Art. no.
① Milling head	3992005
② Cutting plate set	3992006

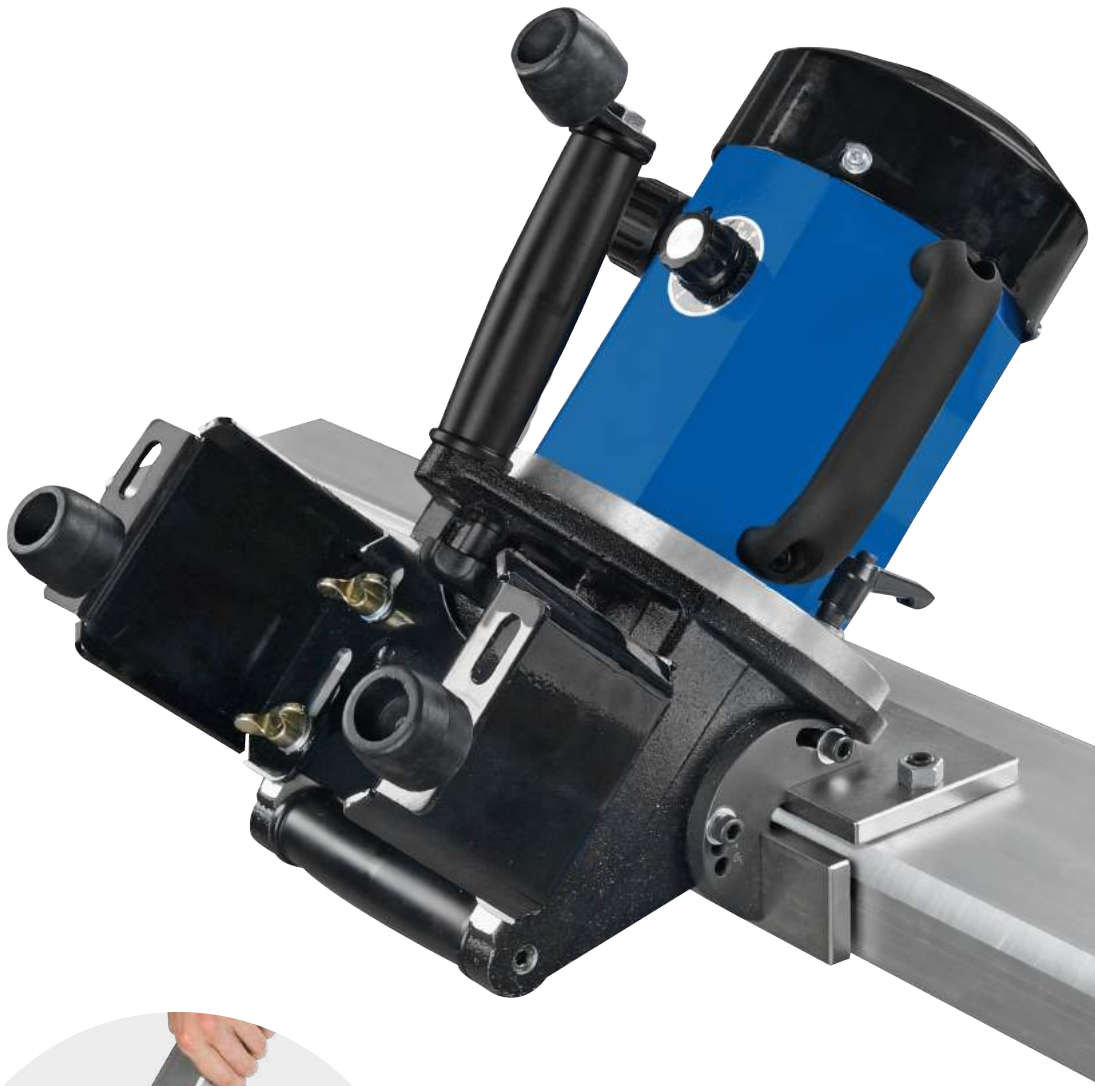

Stationary use

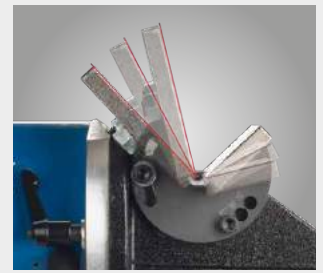

▶ 3 different standard angle settings
15°, 30° and 45°



▶ Chamfer width between
5 and 7 mm



▶ Continuously adjustable
speed control supports
machining of various
materials



▶ Continuously adjustable
chamfer depth setting
without tools supported

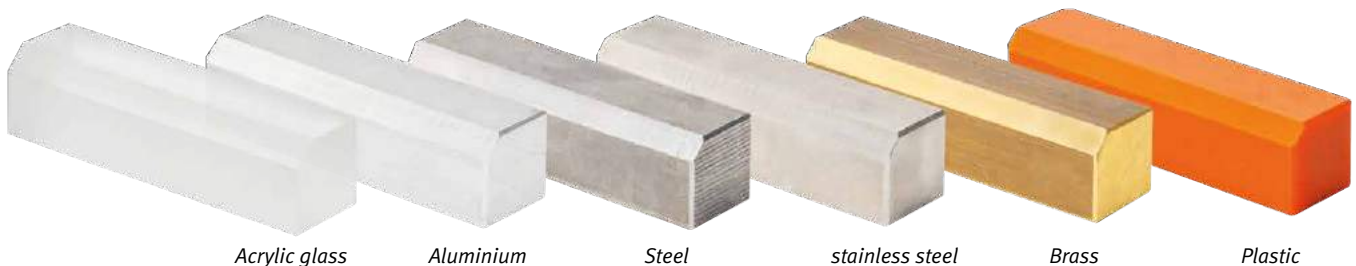

Acrylic glass

Aluminium

Steel

stainless steel

Brass

Plastic

Suitable for machining metals and plastics.

Magnetic drilling

Deburring

Metal grinding

Cutting

Notching & punching

Bending

Presses

Circular saws

Roller conveyors

Metal-cutting band saws

KE 16-2 – Edge deburrer for visible edges and weld seam preparation with continuous angle adjustment from 15 to 60°. Also suitable for deburring pipes thanks to adjustable guide rollers on the mounting table

- ▶ Ideal for creating clean visible edges and weld preparation
- ▶ For machining steel and aluminium
- ▶ Handy and powerful device
- ▶ Setting the chamfering height without tool
- ▶ Also suitable for deburring pipes of 150-350 mm diameter (optionally 300–600 mm) thanks to adjustable guide rollers on the support table
- ▶ Continuously adjustable angle adjustment from 0° - 60°
- ▶ With two 6-fold turnover plate holders
- ▶ Manual feed



KE 16-2 with mounted handle

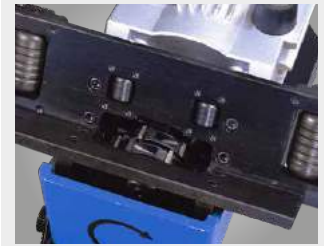

▶ With two 6-fold turnover plate holders



▶ Continuously adjustable angle adjustment from 0° - 60°

▶ With two rollers for easier feeding



▶ Deburring of pipes possible

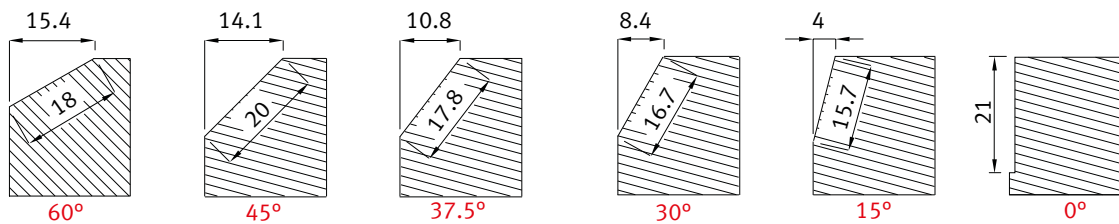

Model	KE 16-2
Art. no.	3990017
Technical specifications	
Chamfer angle	0 / 15 / 30 / 37.5 / 45 / 60°
Chamfer width at 0°	21 mm
Chamfer width at 15°	15.7 mm
Chamfer width at 30°	16.7 mm
Chamfer width at 37.5°	17.8 mm
Chamfer width at 45°	20 mm
Chamfer width at 60°	18 mm
Pipe diameter	150-350 mm (Optionally 300-600 mm)
Electrical connection	230 V/50 Hz
Services	1 100 Watts
Speed	3 000 rpm
Dimensions (L x W x H)	503 x 350 x 248 mm
Weight	20.1 kg

Scope of delivery:

- ▶ Plastic case
- ▶ 2x 6-fold cutting plate holder
- ▶ 1x Cutting plate set consisting of 12 cutting plates
- ▶ 1x Tool kit
- ▶ 1x Front handle



Accessories KE 16-2	Art. no.
1 Milling head	3991605
2 Cutting plate set (12 pieces)	3991606
3 Support plate for pipe Ø 300-600 mm	3991607



Metal grinding

Satin finishing machine



Satin finishing of flat material



Satin finishing of round steel with Velcro non-woven also for e.g. installed stainless steel railings



Easy fixing of the grinding sleeve by pumping up the rubber air roller

SM 100 – Satin finishing machine for grinding, polishing, satin finishing, structuring, and for cleaning soiled surfaces, or removing paint residues

- ▶ For processing stainless steel, cast iron, aluminium, non-ferrous metals, plastics, etc.
- ▶ Highly resilient motor with soft start and overload protection
- ▶ With constant electronics for constant speed, even under load
- ▶ Adapts perfectly to the workpiece by continuously variable speed adjustment
- ▶ Speed can be set conveniently via thumbwheel on rubberised handle
- ▶ Very robust gear housing
- ▶ Tire-free work thanks to ergonomic two-handed operation
- ▶ With hook and loop fastener for reworking of assembled stainless steel railings



Model	SM 100
Art. no.	3990100

Technical specifications	
Max. tool diameter	100 mm
Tool width min./max.	30 / 100 mm
Shaft seating	Ø 19 mm x 100 mm
Idle speed	1 000-2 400 rpm
Output	1 200 W
Electrical connection	230 V / 50 Hz
Weight approx.	4.8 kg

Scope of delivery:

- › Plastic case
- › Pneumatic rubber roller
- › Air pump for pneumatic rubber roller
- › Grinding sleeve non-woven coarse (Ø 90 x 100 mm)
- › Grinding sleeve 60 grain (100 x 292 mm)
- › Grinding sleeve 100 grain (100 x 292 mm)
- › Grinding sleeve K 180 (100 x 292 mm)
- › Drive roll for sanding belts
- › Velcro non-woven (40 x 60 mm)
- › Velcro sanding belt 120 grain (40 x 600 mm)
- › Velcro drive belt (30 x 700 mm)
- › Non-woven roller fine (105 x 100 x 19 mm)
- › Spacer ring set 10-part (40 x 19 x 5 mm)



SM 100 with mounted fine non-woven roller

Accessories

Accessories	Dimensions in mm	Grit size	Art. no.	PQ
1 Non-woven roller	105 x 100 x 19.1	Coarse	3726700	5
Non-woven roller	105 x 100 x 19.1	Medium	3726701	5
Non-woven roller	105 x 100 x 19.1	Fine	3726702	5
Non-woven roller	105 x 100 x 19.1	Very fine	3726703	5
Woven/Non-woven combination	104 x 100 x 19.1	40 grain	3726710	5
Woven/Non-woven combination	104 x 100 x 19.1	60 grain	3726711	5
Woven/Non-woven combination	104 x 100 x 19.1	80 grain	3726712	5
Woven/Non-woven combination	104 x 100 x 19.1	100 grain	3726713	5
Woven/Non-woven combination	104 x 100 x 19.1	120 grain	3726714	5
Woven/Non-woven combination	104 x 100 x 19.1	150 grain	3726715	5
Brush sander	100 x 100 x 19.1	40 grain	3726720	5
Brush sander	100 x 100 x 19.1	60 grain	3726721	5
Brush sander	100 x 100 x 19.1	80 grain	3726722	5
Brush sander	100 x 100 x 19.1	120 grain	3726723	5
Brush sander	100 x 100 x 19.1	240 grain	3726724	5
Inflatable				
2 Expansion roller	90 x 90		3726809	1
3 Expansion roller	90 x 90 x 19.1		3726735	1
Air pump			3726810	1
Zircon grinding sleeve	90 x 100	180 grain	3726740	10
Zircon grinding sleeve	90 x 100	220 grain	3726741	10
4 Zircon grinding sleeve	90 x 100	40 grain	3726845	10
Zircon grinding sleeve	90 x 100	60 grain	3726846	10
Zircon grinding sleeve	90 x 100	80 grain	3726847	10
Zircon grinding sleeve	90 x 100	120 grain	3726848	10
5 Non-woven sleeve, coarse	90 x 100	80 grain	3726750	10
Non-woven sleeve, medium	90 x 100	120 grain	3726751	10
Non-woven sleeve, ultra-fine	90 x 100	240 grain	3726752	10
Trizact sleeve	90 x 100	A16	3726760	10
Trizact sleeve	90 x 100	A30	3726761	10
Trizact sleeve	90 x 100	A45	3726762	10
Trizact sleeve	90 x 100	A65	3726763	10
Trizact sleeve	90 x 100	A100	3726764	10
Trizact band	618 x 40	A16	3726855	10
Trizact band	618 x 40	A30	3726856	10
Trizact band	618 x 40	A45	3726857	10
Trizact band	618 x 40	A65	3726858	10
Trizact band	618 x 40	A100	3726859	10

Accessories	Dimensions in mm	Grit size	Art. no.	PQ
Grit-permeated Nylon coarse non-woven	100 x 100 x 19.1		3726770	1
Steel strand brush Ø 0.3 mm	100 x 100 x 19.1		3726776	1
VA wire brush Ø 0.2 mm	100 x 100 x 19.1		3726777	1
Plastic brush (grain)	100 x 100 x 19.1	80 grain	3726778	1
Plastic brush (grain)	100 x 100 x 19.1	46 grain	3726779	1
Polishing disc normal	100 x 19.1		3726780	7
Polishing disc, gloss	100 x 19.1		3726781	10
Granular rubber wheel	104 x 100 x 19.1	16 grain	3726785	1
Granular rubber wheel	104 x 100 x 19.1	46 grain	3726786	1
Granular rubber wheel	104 x 100 x 19.1	120 grain	3726787	1
6 Roller for sanding belts	65 x 100 x 19.1		3726791	1
Woven fabric sanding belt (open)	600 x 40	60 grain	3726795	10
Woven fabric sanding belt (open)	600 x 40	80 grain	3726796	10
Woven fabric sanding belt (open)	600 x 40	120 grain	3726797	10
Sanding belt for surface machining (open)	600 x 40	Coarse	3726803	10
Sanding belt for surface machining (open)	600 x 40	Medium	3726804	10
Sanding belt for surface machining (open)	600 x 40	Fine	3726805	10
Felt sanding belt (open)	600 x 40		3726806	10
7 Velcro closure for open bands	500 x 30		3726807	1
Abrasive roller KIT			3726808	1
8 Non-woven band	618 x 40	80	3726850	10
Non-woven band	618 x 40	120	3726851	10
Non-woven band	618 x 40	240	3726852	10
Zircon corundum band	618 x 40	40	3726860	10
Zircon corundum band	618 x 40	60	3726861	10
Zircon corundum band	618 x 40	80	3726862	10
Zircon corundum band	618 x 40	120	3726863	10

Pipe sanding machine

RSM 620 – Pipe grinding machine with pivoting grinding arm

- ▶ With continuously variable setting of the belt speed for optimum adjustment for various applications
- ▶ Pivoting grinding arm for optimum adjustment to the required grinding position
- ▶ Tire-free work thanks to ergonomic two-handed operation
- ▶ Handle can be screwed in at various positions for optimised handling
- ▶ Weld grinding on flat surfaces without tilting or ripple thanks to large contact roller
- ▶ Ideal for grinding of stainless steel welds without blue discolouration due to heat dissipation via the sanding belt
- ▶ Highly resilient motor with soft start and overload protection
- ▶ With constant electronics for constant belt speed, even under load
- ▶ Easy sanding belt replacement without tools
- ▶ Speed can be set conveniently via thumbwheel on the handle

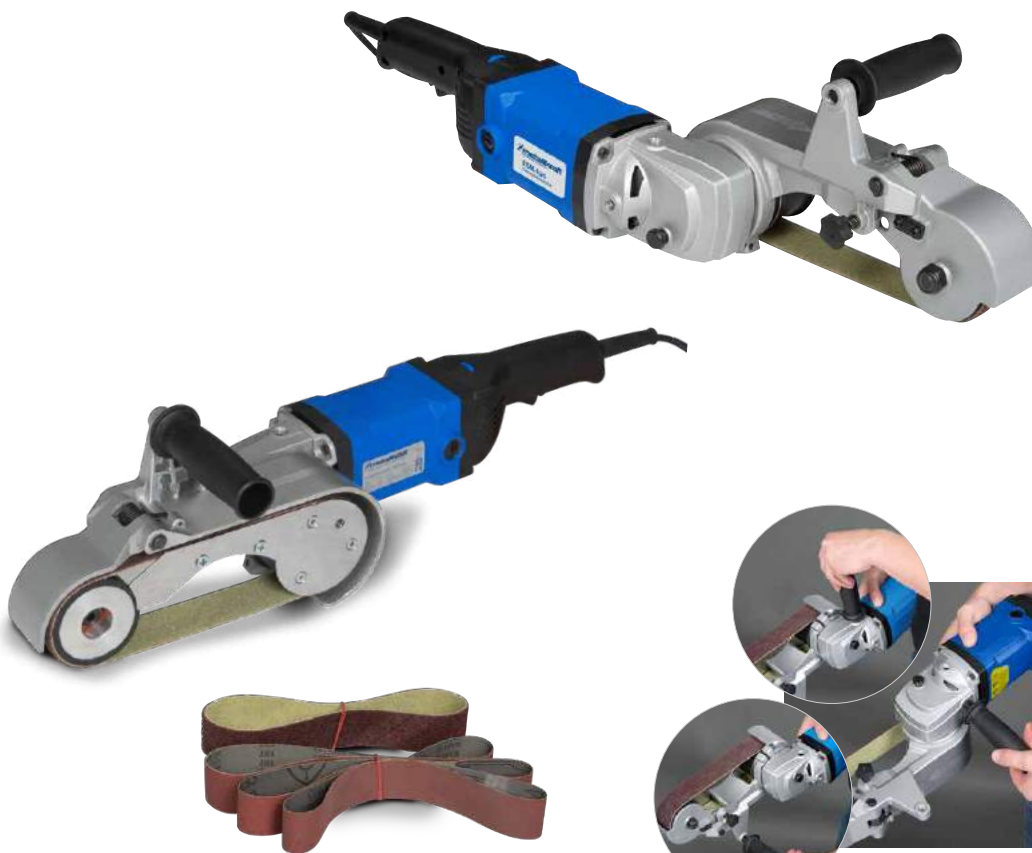

Abrasive for RSM 620 - bands shown included in the scope of delivery

Handle can be screwed in at three different positions



Flat material grinding



Satin finishing of vertical round material



Satin finishing of horizontal round material



Pivoting grinding arm for optimum adjustment to the required grinding position

Model	RSM 620
Art. no.	3990620
Technical specifications	
Belt length	620 mm
Belt width	40 mm
Pipe Ø min.	15 mm
Belt speed	15 - 28 m/sec.
Idle speed	2 300/6 500 rpm
Services	1 500 W
Electrical connection	230 V / 50 Hz
Weight approx.	5.3 kg

Scope of delivery:

- › Handle
- › Sanding belt 60 grain (40 x 620 mm)
- › Sanding belt 100 grain (40 x 620 mm)
- › Sanding belt 180 grain (40 x 620 mm)
- › Grinding pad coarse (40 x 620 mm)

Accessories	Dimensions	Grit size	Art. no.	PQ
Trizact band	618 x 40 mm	A16	3726855	10
Trizact band	618 x 40 mm	A30	3726856	10
Trizact band	618 x 40 mm	A45	3726857	10
Trizact band	618 x 40 mm	A65	3726858	10
Trizact band	618 x 40 mm	A100	3726859	10
Non-woven band	618 x 40 mm	80	3726850	10
Non-woven band	618 x 40 mm	120	3726851	10
Non-woven band	618 x 40 mm	240	3726852	10
Zircon corundum band	618 x 40 mm	40	3726860	10
Zircon corundum band	618 x 40 mm	60	3726861	10
Zircon corundum band	618 x 40 mm	80	3726862	10
Zircon corundum band	618 x 40 mm	120	3726863	10

RSM 760 – Pipe grinding device for handy and flexible use for grinding, polishing and satin finishing work

- ▶ Pipe grinding device for handy and flexible use for metalworking, steel construction work and railing construction
- ▶ Designed for grinding and polishing pipe constructions
- ▶ Specially suited for grinding, satin finishing and high-gloss polishing of installed railings
- ▶ Ideal for working in cramped conditions, as the handle rotates through 180°
- ▶ Highly resilient motor with soft start and overload protection
- ▶ With constant electronics for constant belt speed, even under load
- ▶ With continuously variable setting of the belt speed for optimum adjustment for various applications
- ▶ Speed can be set conveniently via thumbwheel on the handle
- ▶ Easy sanding belt replacement without tools
- ▶ 360° circumferential grinding in just two steps
- ▶ Premium 270° grinding arm made of lightweight metal with 2 deflection rollers
- ▶ Handle can be screwed in at various positions for optimised handling



Fig. shows complete scope of delivery of RSM 760



Handle for ergonomic work can be screwed in at various positions



Perfect for grinding and polishing pipe constructions



Only two work steps necessary for 360° circumference grinding



Especially suitable for processing installed railings

Model	RSM 760
Art. no.	3990760
Technical specifications	
Max. belt length	760 mm
Belt width	40 mm/20 mm
Pipe Ø min.	15 mm
Belt speed	3 - 12 m/sec.
Idle speed	1 600/3 200 rpm
Services	1 200 W
Electrical connection	230 V / 50 Hz
Weight approx.	3.4 kg

Scope of delivery:

- > Plastic case
- > Grinding pad coarse (40 x 760 mm)
- > 5 pieces sanding belt 120 grain (40 x 760 mm)
- > 5 pieces sanding belt 220 grain (40 x 760 mm)

Accessories	Dimensions	Grit size	Art. no.	PQ
Non-woven band	760 x 40 mm	80	3726865	10
Non-woven band	760 x 40 mm	120	3726866	10
Non-woven band	760 x 40 mm	240	3726867	10
Non-woven band	760 x 40 mm	400	3726868	10
Trizact band	760 x 40 mm	A16	3726870	10
Trizact band	760 x 40 mm	A30	3726871	10
Trizact band	760 x 40 mm	A45	3726872	10
Trizact band	760 x 40 mm	A65	3726873	10
Trizact band	760 x 40 mm	A100	3726874	10
Zircon corundum band	760 x 40 mm	40	3726880	10
Zircon corundum band	760 x 40 mm	60	3726881	10
Zircon corundum band	760 x 40 mm	80	3726882	10
Zircon corundum band	760 x 40 mm	120	3726883	10
Zircon corundum band	760 x 40 mm	220	3726884	10

Brush deburring grinder/belt and disc grinders

BEG – Universal brush deburring device



- ▶ With shaft-mounted round brush as standard (250 x 40 x 24 mm with 0.5 mm Ø wire) for processing steel
- ▶ Adjustable prism workpiece support

- ▶ Large sight protection glass for protection against sparks and flying swarf
- ▶ S version including extraction unit with separate motor and filter bar



Large sight protection glass



Adjustable prism workpiece support



BEG 250

Emergency off switch foot-operable



BEG 250 S

Filter bag in scope of delivery (BEG 250 S)

Model	BEG 250	BEG 250 S
Art. no.	3730250	3730251
Technical specifications		
Brush dimensions	Ø 250 x 40 mm	Ø 250 x 40 mm
Brush bore hole	Ø 24 mm	Ø 24 mm
Brush speed	3 000 rpm	3 000 rpm
Motor output	2.2 kW	2.2 kW
Electrical connection	400 V / 50 Hz	400 V / 50 Hz
Extraction performance	-	8.5 m ³ /min
Dimensions (L x W x H)	420 x 500 x 1 120 mm	440 x 600 x 1120 mm
Weight	50 kg	60 kg

Accessories	Art. no.
Round brush 250 x 30mm Wire Ø 0.2 mm for steel	3730260
Round brush 250 x 30mm Wire Ø 0.3 mm for steel	3730261
Round brush 250 x 30mm Wire Ø 0.2 mm for stainless steel	3730264
Round brush 250 x 30mm Wire Ø 0.3 mm for stainless steel	3730265
Replacement filter bag (for BEG 250 S only)	3722150

BTS 51 – Combined belt and disc grinding machine with swivelling grinding arm

- ▶ Pneumatic sanding belt tension manually adjustable
- ▶ Fine adjustment for parallel belt run
- ▶ 2 sanding tables, swivelling via clamping lever
- ▶ With sanding belt (80 grain) and sanding disc (80 grain) as standard
- ▶ Powerful motor
- ▶ With extraction port on spark trap as standard
- ▶ Sanding belt changed within seconds thanks to simple operation
- ▶ Can easily be fixed on the workbench

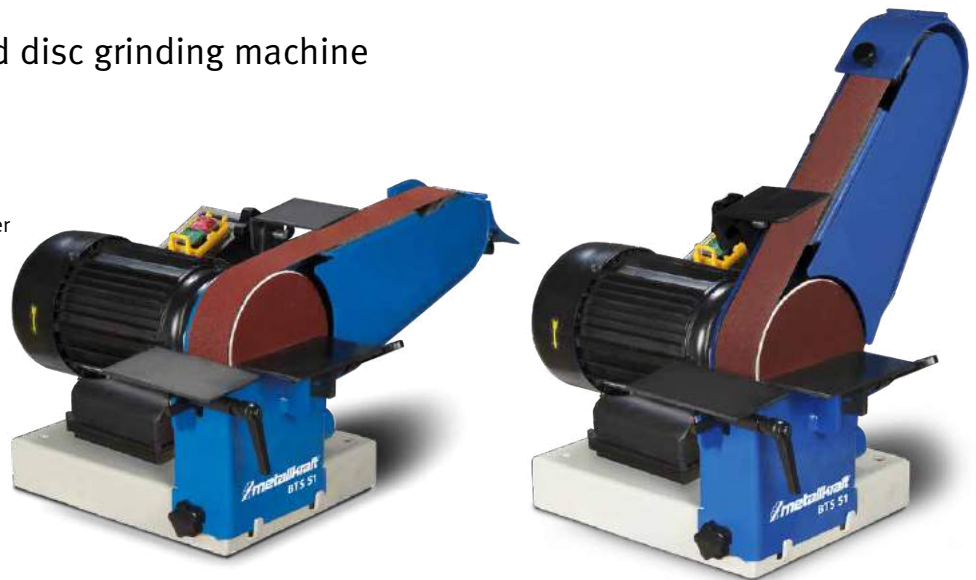

Model	BTS 51
Art. no.	3700051
Technical specifications	
Sanding belt dimensions	50 x 1 000 mm
Sanding disc Ø	150 mm
Belt speed	22 m/sec.
Drive wheel Ø	152 mm
Contact wheel Ø	75 mm
Dimensions graphite support	160 x 60 x 1.5 mm
Motor output	750 W
Electrical connection	230 V / 50 Hz
Dimensions in mm	375 x 230 x 620
Weight	20 kg

Accessories	Art. no.	PQ
Graphite support BTS 51	3721001	10
Sanding belt 1 000 x 50 mm 40 grain	3721004	10
Sanding belt 1 000 x 50 mm 60 grain	3721006	10
Sanding belt 1 000 x 50 mm 80 grain	3721008	10
Sanding belt 1 000 x 50 mm 100 grain	3721010	10
Velcro support Ø 150 mm	5911001	10
Sanding disc Velcro Ø 150 mm 60 grain	5911506	10
Sanding disc Velcro Ø 150 mm 80 grain	5911508	10
Sanding disc Velcro Ø 150 mm 100 grain	5911510	10
Sanding disc Velcro Ø 150 mm 120 grain	5911512	10
Sanding disc Velcro Ø 150 mm 150 grain	5911515	10
Sanding disc Velcro Ø 150 mm 180 grain	5911518	10

AS 1400 – Extractor set suitable for MBSM 100-130 and MBSM 100-130-2

AS 1601 – Extractor set suitable for MBSM 75-200-2 and MBSM 150-200-2

- ▶ Fast and easy filter replacement
- ▶ Large catchment container with fast access via drawer
- ▶ Compact and stable housing
- ▶ High-capacity interior
- ▶ Effective extraction

- AS 1601**
- ▶ Including dust bag



AS 1400

Scope of supply AS 1400:

- > 4x hose clamp Ø70 - 90 mm
- > 1x extraction hose Ø 75 mm/ 1 m
- > 1x extraction hose Ø 75 mm/ 2 m

Scope of supply AS 1601:

- > 1x Dust bag
- > 4x hose clamps 100 - 120 mm
- > 1x extraction hose Ø 100 mm/ 1 m
- > 1x extraction hose Ø 100 mm/ 2 m



AS 1601

Model	AS 1400	AS 1601
Art. no.	3922011	3922006
Technical specifications		
Motor output	0.55 kW	0.75 kW
Electrical connection	230 V / 50 Hz	400 V / 50 Hz
Extraction duct	2 x Ø 75 mm	2 x Ø 100 mm
Suction performance without dust bag/hoses	840 m³/h	1,100 m³/h
Dimensions without dust bag	920 x 590 x 850 mm	560 x 840 x 1 180 mm
Weight	58 kg	36 kg

Accessories AS 1400	Art. no.
1 m extraction hose Ø 75 mm	3922012
2 m extraction hose Ø 75 mm	3922013
Replacement filter	3922014

Accessories AS 1601	Art. no.
1 m extraction hose Ø 100 mm	3922003
2 m extraction hose Ø 100 mm	3922004
Dust collection bag	3922002

Combined pipe and section grinder

KRBS 101 – Combined pipe, section and belt grinding machine

- ▶ Convenient operation thanks to easily adjustable clamping device
- ▶ The rotating clamping jaws on the clamping device allow for safe clamping of square tubes, round tubes and flat steel
- ▶ Adjustable grinding angle from 30 - 90° and from 0° - 60°
- ▶ Thanks to the optimised quick-release holder, the tension pulley can be easily and quickly replaced without tools
- ▶ Long service life thanks to larger and improved roller bearing
- ▶ Practical grinding roller holders integrated in substructure
- ▶ Comprehensive range of grinding rollers for grinding various pipe diameters available as accessories
- ▶ Fast change-over between pipe grinding and belt grinding possible
- ▶ Powerful motor
- ▶ Almost all settings can be made without tools (operating tool included in scope of delivery)
- ▶ Large, folding protection pane with optimised view field
- ▶ Optimum adjustment to material in question thanks to 2 belt speeds (15 m/s perfect for stainless steel and aluminium, 30 m/s perfect for steel)
- ▶ With two easily removable swarf catchment containers
- ▶ Extraction port (Ø 70 mm) available for extraction systems



Fig. shows rear side for deburring grinding with a practical workpiece support and swarf catchment container

Model	KRBS 101
Art. no.	3921001
Technical specifications	
Belt dimensions	100 x 2 000 mm
Motor output	2.5 kW/3.3 kW
Electrical connection	400 V / 50 Hz
Motor speed	1 400/2 800 rpm
Belt speed	15–30 m/s
Grindable diameter	20 - 76 mm
Adjustable grinding angle	30 - 90° (0° - 60°)
Extraction duct nominal width outside	2 x 74 mm
Dimensions L x W x H	1 250 x 750 x 1 140 mm
Weight	159 kg

- Scope of supply KRBS 101:**
- > 1 x Standard grinding belt 36 grain
 - > 2 x Swarf catchment containers
 - > 1 x Spanner
 - > 1 x Grinding roll 42 mm

Accessories	Art. no.
Roller for 3/8" pipe	3723050
Roller for 1/2" pipe	3723051
Roller for 22 mm pipe	3723052
Roller for 3/4" pipe	3723053
Roller for 28 mm pipe	3723054
Roller for 1" pipe	3723055
Roller for 34 mm pipe	3723056
Roller for 1 1/4" pipe	3723057
Roller for 44 mm pipe	3723058
Roller for 1 1/2" pipe	3723059
Roller for 50 mm pipe	3723060
Roller for 2" pipe	3723061
Roller for 62 mm pipe	3723062
Roller for 2 1/2" pipe	3723063
Roller for 78 mm pipe	3723064



▶ Large flat grinding surface with tool stop

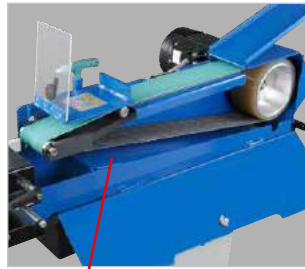

▶ The baffle guides the grinding dust optimally to the rear swarf discharge point

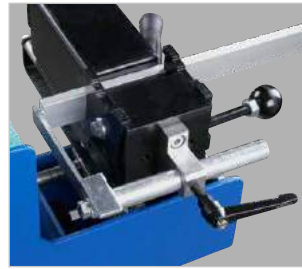

▶ Cross-cut fence adjustable without tools (only for 90°)

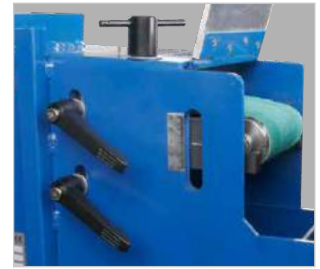

▶ Easy height adjustment of grinding belt without tools

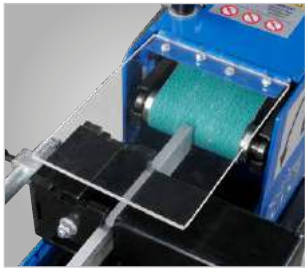

▶ Large, folding protection pane with optimised view field

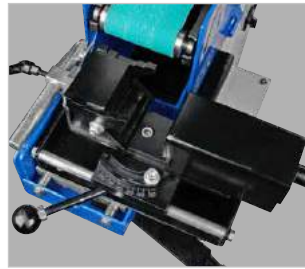

▶ Safe and easy workpiece guidance thanks to easily adjustable clamping device

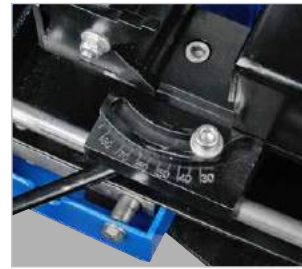

▶ Grinding angle of 30-90° adjustable based on scale



▶ With integrated grinding roller holder for optionally available grinding rollers with various diameters

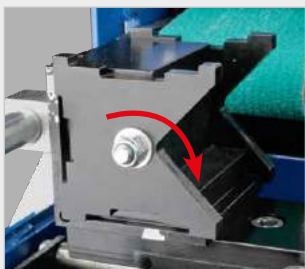

- The rotating clamping jaws on the clamping device allow for safe clamping of square tubes, round tubes and flat steel
- The prism jaws allow for clamping of round tubes and square tubes.
- The additional clamping sections allow for precise clamping of workpieces such as flat steel or square tubes

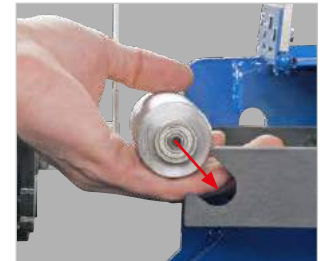
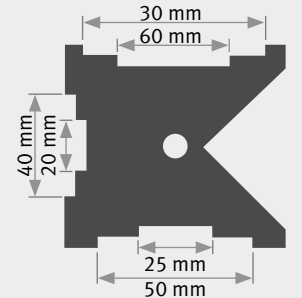

▶ Thanks to the optimised quick-release holder, the grinding roller can be easily and quickly replaced without tools



▶ Both swarf catchment containers are easily removable



Optional extraction unit AS 1400 (see page 41)

Grinding belt 2 000 x 100 mm		Art. no.	PQ
40 grain	Grinding aluminium	3724740	10
60 grain	Grinding aluminium	3724760	10
100 grain	Grinding aluminium	3724710	10
120 grain	Grinding aluminium	3724712	10
40 grain	Grinding stainless steel	3724840	10
60 grain	Grinding stainless steel	3724860	10
100 grain	Grinding stainless steel	3724810	10
120 grain	Grinding stainless steel	3724812	10

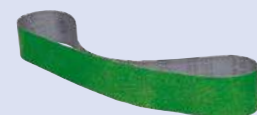

Belt sanders

MBSM - Belt grinding machines

- ▶ Metal belt grinders for grinding surfaces, edges, and for rounding
- ▶ Powerful motors and vibration-free action for best grinding results
- ▶ Protective screen folds away
- ▶ Grinding belt changed within seconds thanks to quick-release system
- ▶ Large surface grinding area as upper grinding belt cover can be folded away
- ▶ Usable with or without extraction unit
- ▶ With extraction ports directly on the spark box and rear idler

- ▶ Continuous planing surface after removing attachment parts - allows for grinding of long workpieces
- ▶ Easy adjustment of belt action thanks to adjustment screw
- ▶ Automatic re-tensioning of the grinding belt thanks to spring-supported belt tensioning system

MBSM 100-130 and MBSM 100-130-2

- ▶ Can be used as a workbench and upright model (using the optional chassis)

MBSM 100-130-2, 75-200-2 and 150-200-2

- ▶ With two belt speeds - for grinding steel and stainless steel

MBSM 75-200 and MBSM 150-200-2

- ▶ Continuously variable grinding unit



MBSM 100-130-2
With optional chassis



MBSM 100-130

- ▶ 230 Volt model with a single belt speed
- ▶ Standard scope of supply for use as a desktop model

- ▶ For all models, continuous planing surface thanks to removable attachment parts
- ▶ Allows for grinding of long workpieces

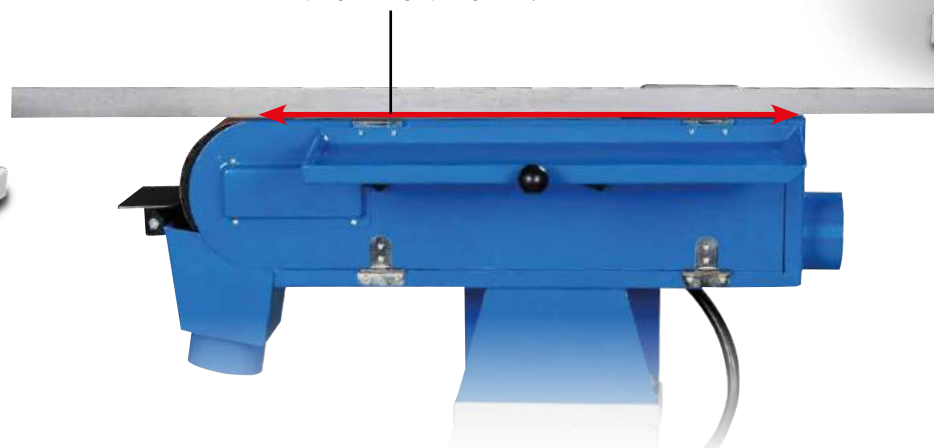

Model	MBSM 100-130	MBSM 100-130-2	MBSM 75-200-1 (230 V)	MBSM 75-200-1 (400 V)	MBSM 75-200-2	MBSM 150-200-2
Art. no.	3921226	3921225	3922070	3922071	3922075	3922150
Technical specifications						
Grinding width	100 mm	100 mm	75 mm	75 mm	75 mm	150 mm
Belt speed	19 m/s	9.5–19 m/s	29 m/s	29 m/s	14.5–29 m/s	14.5–29 m/s
Motor output	1.5 kW	1.5 kW	3 kW	3 kW	1.5-2.2 kW	2.2-2.8 kW
Electrical connection	230 V / 50 Hz	400 V / 50 Hz	230 V / 50 Hz	400 V / 50 Hz	400 V / 50 Hz	400 V / 50 Hz
Grinding belt dimensions	100 x 1 220 mm	100 x 1 220 mm	75 x 2 000 mm	75 x 2 000 mm	75 x 2 000 mm	150 x 2 000 mm
Contact wheel Ø	130 mm	130 mm	200 mm	200 mm	200 mm	200 mm
Extraction duct nominal width outside	2 x 75 mm	2 x 75 mm	2 x 100 mm	2 x 100 mm	2 x 100 mm	2 x 100 mm
Dimensions in mm (L x W x H)	690 x 390 x 360	690 x 390 x 360	1 070 x 340 x 950	1 070 x 340 x 950	1 070 x 340 x 950	1 070 x 415 x 950
Weight	37 kg	37 kg	72 kg	72 kg	72 kg	90 kg



MBSM 150-200-2

MBSM 75-200-2

Matching extraction units
on Page 41



Fast grinding belt replacement thanks to quick-clamping system (Fig. MBSM 150-200-2)



Extraction port Ø 100 mm (Fig. MBSM 150-200-2)



Generously dimensioned contact and drive wheels (Fig. MBSM 150-200-2)

Accessories MBSM 100-130 / MBSM 100-130-2	Art. no.	PQ
Optional chassis	3921227	1
Contact wheel	3921222	1
Graphite support	3921230	1
Grinding belts 100 x 1 220 mm		
40 grain	3726040	10
60 grain	3726060	10
80 grain	3726080	10
120 grain	3726120	10
Standard set 100 x 1220	3726000	1
consisting of: 3x40 grain, 4x80 grain, 3x 120 grain		
Grinding belts 100 x 1 220 mm for extreme spot load		
40 grain	3727040	10
60 grain	3727060	10
80 grain	3727080	10
100 grain	3727120	10
Woven fabric set 100 x 1 220	3726001	1
consisting of: 3x 40 grain, 4x 80 grain, 3x 120 grain		

Accessories MBSM 75-200-2	Art. no.	PQ
Contact wheel	3922076	1
Graphite support	3921231	1
Grinding belts 75 x 2 000 mm		
40 grain	3722004	10
60 grain	3722006	10
80 grain	3722008	10
120 grain	3722009	10
Standard set 75 x 2000	3722000	1
consisting of: 3x40 grain, 4x 80 grain, 3x 120 grain		
Grinding belts 75 x 2 000 mm for extreme spot load		
24 grain	3722022	10
36 grain	3722023	10
40 grain	3722024	10
60 grain	3722026	10
Woven fabric set 75 x 2 000	3722001	1
consisting of: 4x 24 grain, 3x 40 grain, 3x 60 grain		

Accessories MBSM 150-200-2	Art. no.	PQ
Contact wheel	3922151	1
Graphite support	3921232	1
Grinding belts 150 x 2 000 mm		
40 grain	3722014	10
60 grain	3722016	10
80 grain	3722018	10
120 grain	3722019	10
Standard set 150 x 2000	3722010	1
consisting of: 3x40 grain, 4x 80 grain, 3x 120 grain		
Grinding belts 150 x 2 000 mm for extreme spot load		
24 grain	3723022	10
36 grain	3723023	10
40 grain	3723024	10
50 grain	3723025	10
60 grain	3723026	10
Woven fabric set 150 x 2 000	3722011	1
consisting of: 4x 24 grain, 3x 40 grain, 3x 60 grain		

Magnetic drilling
Deburring
Metal grinding
Cutting
Notching & punching
Bending
Presses
Circular saws
Roller conveyors
Metal-cutting band saws

MBSM series – Metal belt grinders with integrated extraction unit

- ▶ Metal belt grinders for grinding surfaces, edges, and for rounding
- ▶ Powerful motors with vibration-free action to achieve the best possible grinding results
- ▶ Protective screen folds away
- ▶ Grinding belt changed within seconds thanks to quick-release system
- ▶ With 2 extraction ports - one directly on the

- ▶ spark box and one on the rear roller
- ▶ Continuous surface grinding area
- ▶ Easy adjustment of belt action thanks to adjustment screw
- ▶ Features motor brake, adjustable working height, protective screen, angle stop and motor circuit breaker as standard
- ▶ Continuously variable grinding unit

MBSM 75-20 AS and MBSM 150-20 AS

- ▶ With 2 integrated extraction units - one directly on the spark box and one on the rear roller



MBSM 75-20



MBSM 75-20 AS

Model	MBSM 75-20	MBSM 75-20 AS	MBSM 150-20	MBSM 150-20 AS
Art. no.	3712075	3712076	3712150	3712151
Technical specifications				
Integrated extraction unit	No	Yes	No	Yes
Grinding width	75 mm	75 mm	150 mm	150 mm
Belt speed	34 m/s	34 m/s	34 m/s	34 m/s
Motor output	3 kW	3.5 kW	3.5 kW	3.5 kW
Electrical connection	3 x 400 V/ 50 Hz	3 x 400 V/ 50 Hz	3 x 400 V/ 50 Hz	3 x 400 V/ 50 Hz
Grinding belt dimensions	75 x 2 000 mm	75 x 2 000 mm	150 x 2 000 mm	150 x 2 000 mm
Contact wheel Ø	200 x 75 x 24 mm	200 x 75 x 24 mm	200 x 150 x 28 mm	200 x 150 x 28 mm
Extraction duct nominal width outside	2 x 100 mm	2 x 100 mm	2 x 100 mm	2 x 100 mm
Intake capacity	–	630 m³/h	–	630 m³/h
Dimensions (L x W x H)	1 025 x 500 x 1 000 mm	1 025 x 500 x 1 000 mm	1 025 x 600 x 1 000 mm	1 025 x 600 x 1 000 mm
Weight	90 kg	91 kg	100 kg	114 kg



MBSM 150-20 AS



Tension/relieve belt via lever



Simple belt tracking adjustment



With 2 extraction ducts

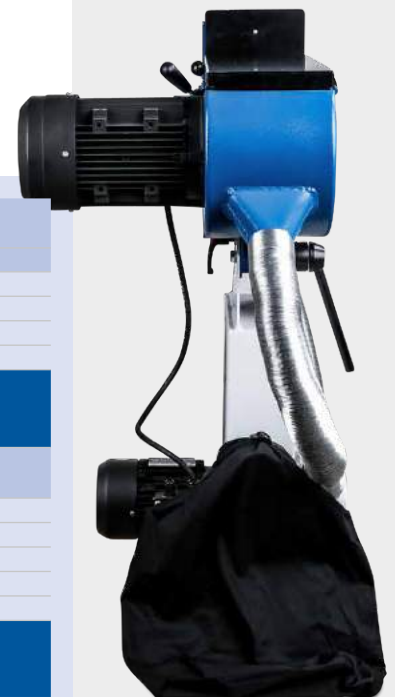

Accessories MBSM 75-20	Art. no.	PQ
Grinding belts 75 x 2 000 mm		
40 grain	3722004	10
60 grain	3722006	10
80 grain	3722008	10
120 grain	3722009	10
Standard set 75 x 2000	3722000	1
<i>consisting of: 3x 40 grain, 4x 80 grain, 3x 120 grain</i>		
Grinding belts 75 x 2 000 mm for extreme spot load		
24 grain	3722022	10
36 grain	3722023	10
40 grain	3722024	10
60 grain	3722026	10
Woven fabric set 75 x 2 000	3722001	1
<i>consisting of: 4x 24 grain, 3x 40 grain, 3x 60 grain</i>		

Accessories MBSM 150-20	Art. no.	PQ
Grinding belts 150 x 2 000 mm		
40 grain	3722014	10
60 grain	3722016	10
80 grain	3722018	10
120 grain	3722019	10
Standard set 150 x 2000	3722010	1
<i>consisting of: 3x 40 grain, 4x 80 grain, 3x 120 grain</i>		
Grinding belts 150 x 2 000 mm for extreme spot load		
24 grain	3723022	10
36 grain	3723023	10
40 grain	3723024	10
50 grain	3723025	10
60 grain	3723026	10
Woven fabric set 150 x 2 000	3722011	1
<i>consisting of: 4x 24 grain, 3x 40 grain, 3x 60 grain</i>		

Magnetic drilling

Deburring

Metal grinding

Cutting

Notching & punching

Bending

Presses

Circular saws

Roller conveyors

Metal-cutting band saws

Long belt sanding machine

MBSM ESE – Long belt grinding machine with pivoting grinding unit for surface grinding and edge grinding of long workpieces

- ▶ For use in the metalworking industry for grinding, structuring and polishing tasks, especially with stainless steel
- ▶ 225 mm, balanced belt rollers for optimum, low-vibration drive action
- ▶ Continuously variable band speed 4.5 – 27 m/s thanks to frequency inverter
- ▶ With electrical table height adjustment
- ▶ With fold-up table, drawer grinding unit and integrated work table lighting
- ▶ Easy action grinding table also under load
- ▶ Easy adjustment of sanding belt
- ▶ Roller grinding shoe for less annealing discolouration during grinding
- ▶ CW/CCW sense of direction as standard

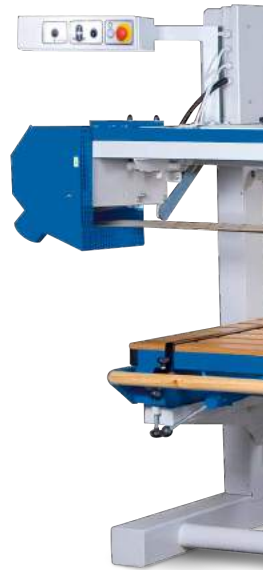

Converts from surface to edge grinding within seconds and without tools!

MBSM 2505 ESE

With pivoted grinding unit for edge grinding

Model	MBSM 1505 ESE	MBSM 2505 ESE	MBSM 3005 ESE
Art. no.	3704015	3704025	3704030
Technical data			
Work table dimensions	1 500 x 800 mm	2 500 x 800 mm	3 000 x 800 mm
Work table height adjustment	540 mm	540 mm	540 mm
Work table transverse stroke	700 mm	700 mm	700 mm
Table load max.	100 kg	100 kg	100 kg
Grinding shoe dimensions	270 x 150 mm	270 x 150 mm	270 x 150 mm
Continuously variable belt speed	4.5–27 m/s	4.5–27 m/s	4.5–27 m/s
Motor output	3 kW (4.0 PS)	3 kW (4.0 PS)	3 kW (4.0 PS)
Electrical connection	400 V / 50 Hz / P 2	400 V / 50 Hz / P 2	400 V / 50 Hz / P 2
Drive roller diameter	225 mm	225 mm	225 mm
Grinding belt dimensions	5 020 x 150 mm	7 000 x 150 mm	8 000 x 150 mm
Machine dimensions	2 500 x 1 300 x 1 450 mm	4 000 x 1 300 x 1 450 mm	4 500 x 1 300 x 1 450 mm
Weight	470 kg	516 kg	530 kg
Extraction duct nominal width outside	160 mm	160 mm	160 mm



Quality
made in
Europe



MBSM 2505 ESE
Can be used as a long belt grinding machine

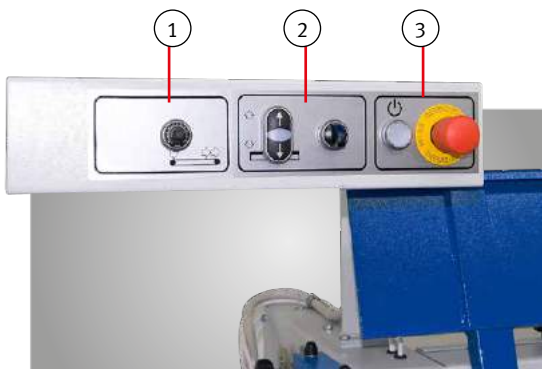

- ▶ Ergonomic control panel at eye level
- ▶ Easy operation from the front
- ▶ With emergency stop switch (3), electrical table height adjustment (2) and potentiometer for continuously variable belt speed (1)

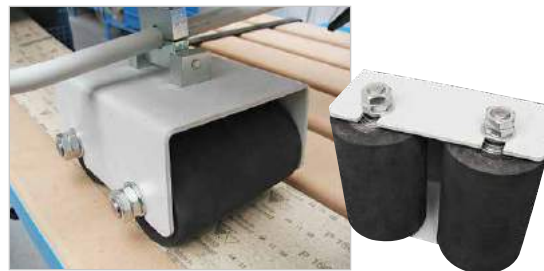

- ▶ Grinding shoe with two large rubber rollers for less friction warming (annealing colour)
- ▶ Also suitable for workpieces with bevelled edges due to pivoting grinding shoe bearing



Application grinding stainless steel
grinding belt deployed 120 grain for surface structuring

Applications

- ▶ For processing aluminium*, steel and stainless steel
- ▶ Structuring finishing of metal surfaces
- ▶ Silk matt or silky lustre finishing with non-woven fabric belt
- ▶ Grinding of long welds
- ▶ Cleaning of surfaces with annealing discolouration after welding

Important notice

***Note the high risk of deflagration for aluminium grinding!**



Matching grinding agents are listed after the two-belt grinding machines.

Accessories	Art. no.
Sliding shoe with graphite support	0532PER33000

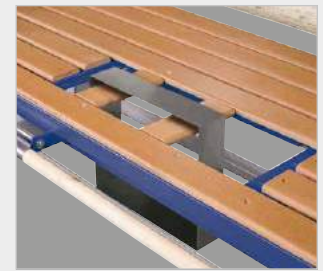

- ▶ with drawer sanding unit as factory standard
- ▶ With folding table for special edge grinding applications



- ▶ Grinding table with stop rail as standard



- ▶ Pivoting unit with quick-release clamping system
- ▶ 3.0 kW motor



- ▶ 225 mm, balanced belt rollers for optimum, low-vibration drive action



with graphite support, specially for fine grinding,
Art. no. 0532PER33000

Grinding belts for MBSM MBSM ESE / MBSM ZB

Grinding and non-woven fabric belts for metal long belt grinding machines MBSM ESE



Grinding belts for MBSM 1505 ESE Dimensions: 150 x 5020 mm			Grinding belts for MBSM 2505 ESE Dimensions: 150 x 7000 mm			Grinding belts for MBSM 3005 ESE Dimensions: 150 x 8 000 mm			Non-woven fabric belts for MBSM 1505 ESE Dimensions: 150 x 5020 mm		
Grit size	Art. no.	PQ	Grit size	Art. no.	PQ	Grit size	Art. no.	PQ	Grit size	Art. no.	PQ
for aluminium grinding*			for aluminium grinding*			for aluminium grinding*			For all materials*		
80	3721180	5	80	3725080	5	80	3724080	5	Coarse	3721701	1
100	3721110	5	100	3725010	5	100	3724010	5	Medium	3721702	1
120	3721112	5	120	3725012	5	120	3724012	5	Fine	3721703	1
150	3721115	5	150	3725015	5	150	3724015	5	Non-woven fabric belts for MBSM 2505 ESE Dimensions: 150 x 7000 mm		
180	3721118	5	180	3725018	5	180	3724018	5	Grit size Art. no. PQ		
220	3721122	5	220	3725022	5	220	3724022	5	For all materials*		
240	3721124	5	240	3725024	5	240	3724024	5	Coarse	3723301	1
For stainless steel and steel grinding			For stainless steel and steel grinding			For stainless steel and steel grinding			Medium	3723302	1
80	3721280	5	40	3723040	5	80	3724180	5	Fine	3723303	1
100	3721210	5	80	3723080	5	100	3724110	5	Non-woven fabric belts for MBSM 3005 ESE Dimensions: 150 x 8 000 mm		
120	3721212	5	100	3723010	5	120	3724112	5	Grit size Art. no. PQ		
150	3721215	5	120	3723012	5	150	3724115	5	For all materials*		
180	3721218	5	150	3723015	5	180	3724118	5	Coarse	3724401	1
220	3721222	5	180	3723018	5	220	3724122	5	Medium	3724402	1
240	3721224	5	220	3723032	5	240	3724124	5	Fine	3724403	1
For stainless steel pre-grinding**			For stainless steel pre-grinding**			For stainless steel pre-grinding**			Non-woven fabric belts for MBSM 1505 ESE Dimensions: 150 x 5020 mm		
80	3721380	5	80	3723180	5	80	3724280	5	Grit size Art. no. PQ		
120	3721412	5	120	3723112	5	120	3724212	5	For all materials*		
150	3721515	5	For stainless steel pre-grinding***			For stainless steel pre-grinding***			Coarse	3724401	1
For stainless steel pre-grinding***			For stainless steel pre-grinding***			For stainless steel pre-grinding***			Medium	3724402	1
80	3721680	5	40	3723240	5	80	3724380	5	Fine	3724403	1
100	3721610	5	80	3723280	5	100	3724310	5	Specially for steel grinding		
120	3721612	5	100	3723210	5	120	3724312	5	80	3724680	5
150	3721615	5	120	3723212	5	150	3724315	5	100	3724610	5
180	3721618	5	150	3723215	5	180	3724318	5	120	3724612	5
Specially for steel grinding			180	3723218	5	Specially for steel grinding			150	3724615	5
80	3721880	5	Specially for steel grinding			80	3724680	5	180	3724618	5
100	3721810	5	80	3723580	5	100	3724610	5	220	3724622	5
120	3721812	5	100	3723510	5	120	3724612	5	240	3724624	5
150	3721815	5	120	3723512	5	150	3724615	5			
180	3721818	5	150	3723515	5	180	3724618	5			
220	3721822	5	180	3723518	5	220	3724622	5			
240	3721824	5	220	3723522	5	240	3724624	5			
			240	3723524	5						

* Due to the high risk of deflagration, ensure that only wet grinding is performed on aluminium!

** With polyester support, perfectly suited if the contact pressure for grinding is very high, or for wet grinding

*** With softer woven support made of cotton

FINANCING THROUGH LEASING

Leasing offers companies a number of advantages over purchase or credit financing. The most important aspects are:

Tax benefits

Leasing instalments are fully tax deductible as operating expenses if the leased object is assigned to the lessor for tax purposes.

Balance sheet neutral

Leasing objects do not appear in the lessee's balance sheet. Only the leasing instalments are recorded as operating expenses in the profit and loss account. The equity ratio and the debt ratio do not change. The lessor capitalises the leased asset as fixed assets or leased assets. (Off-balance-sheet financing)

Calculation basis

The leasing rate is not influenced by changes in interest rates or ratings, even in the long term, and thus serves as a reliable basis for calculation.

Liquidity

Since the leasing company is responsible for financing the object, the lessee has more financial leeway for future decisions. Additionally, dependency on banks is reduced.

"Pay as you earn" considerations

As the leasing instalments are due parallel to the use of the object, the leasing object more or less finances itself (effect/cost congruity). Financing costs are spread over the duration of use and thus also over the period in which income is generated from the object. Advance financing is thus avoided.

Planning reliability

The amount of the leasing instalments and contract term are fixed from the start.

Individual contract design

The individual contract design with regard to term, amortisation and payment flow, and method of payment makes it possible to adapt to different needs.



Please ask us for your personal quotation!

Talk to your retailer or request information by email **free of charge and without obligation** at leasing@stma.de.



Precision surface grinders

FSM – Precision grinding machines with NC controlled vertical feed

- ▶ For precision surface grinding work in industrial applications
- ▶ Maximum stiffness and stability thanks to stress-free tempered and hardened cast iron design
- ▶ IP65-protected halogen lighting
- ▶ With automatic centralised lubrication system for all guide rails and spindles
- ▶ Electro-magnetic clamping plate for holding the workpiece incl. automatic degaussing function
- ▶ Premium spindle with precision taper roller bearings (roundness precision 2 µm)
- ▶ Flat V guides, hand-shaved and coated "Turcite-B" guarantee extremely uniform, low-friction movement and maximum precision
- ▶ Second grinding wheel flange

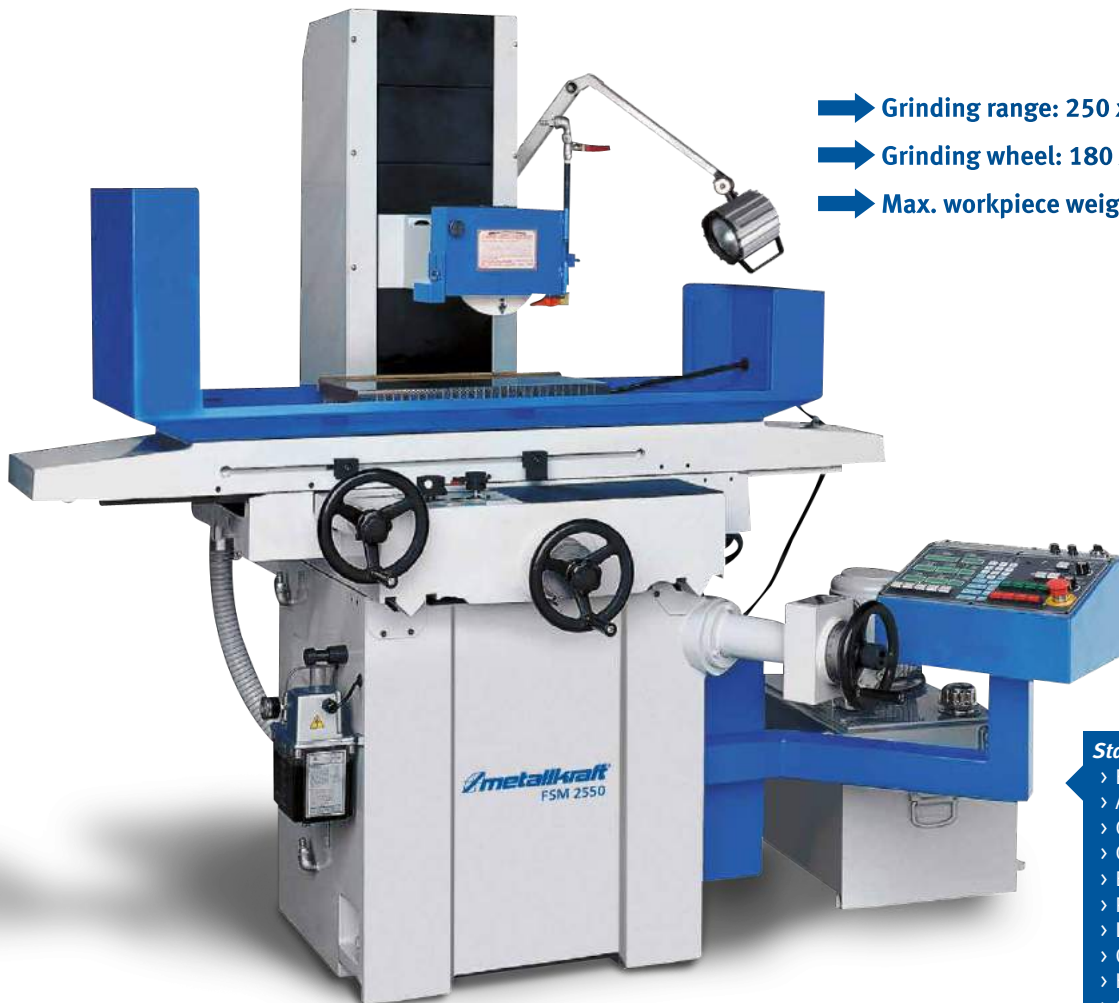

- ➔ Grinding range: 250 x 500 mm
- ➔ Grinding wheel: 180 x 13 x 31.7 mm
- ➔ Max. workpiece weight: 190 kg

FSM 2550

Standard equipment

- › Electro-magnetic clamping plate
- › Automatic degaussing unit
- › Grinding wheel flange
- › Grinding wheel
- › Balancing mandrel
- › Parallel dressing unit
- › Levelling feet
- › Operating tool
- › Halogen work lamp (IP65)
- › Coolant equipment

Model	FSM 1545	FSM 2045	FSM 2550
Art. no.	3931545	3932045	3932550
Technical specifications			
Size of clamping plate	150 x 450 mm	200 x 450 mm	250 x 500 mm
max. distance between distance and table	450 mm	450 mm	500 mm
Traversing speed of table	5 - 25 m/min.	5 - 25 m/min.	5 - 25 m/min.
Max. workpiece weight	110 kg	110 kg	190 kg
Spindle speed	2 900 rpm	2 900 rpm	2 900 rpm
Size of grinding wheel	180 x 13 x 31.7	180 x 13 x 31.7 mm	180 x 13 x 31.7 mm
Spindle motor output	1.5 kW	1.5 kW	1.5 kW
Hydraulic pump motor output	0.75 kW	0.75 kW	0.75 kW
Electrical connection	400 V / 50 Hz	400 V / 50 Hz	400 V / 50 Hz
Dimensions (L x W x H)	1 900 x 1 300 x 1 700 mm	2 080 x 1 200 x 1 800 mm	2 250 x 1 400 x 1 800 mm
Weight	900 kg	950 kg	1 350 kg

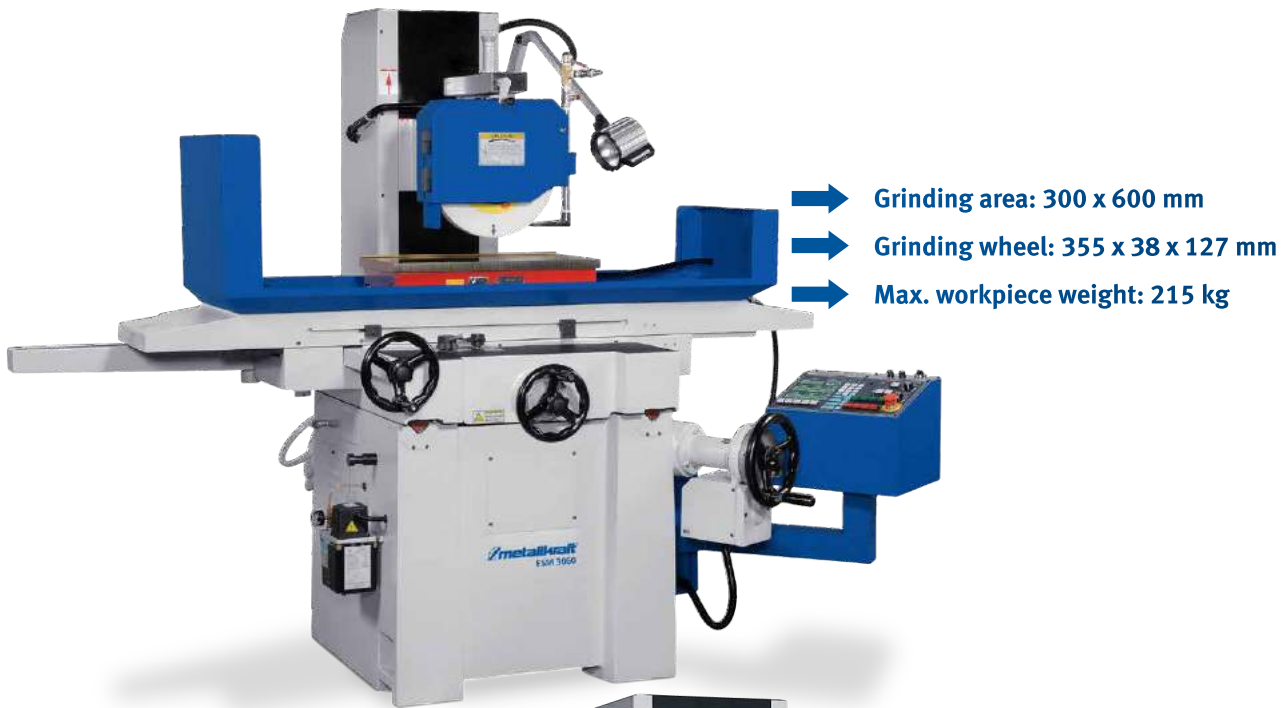

FSM 3060



Layout and function

1. Halogen work lamp
2. Coolant nozzle
3. Electromagnetic clamping plate
4. Adjustable cams longitudinal feed
5. Control panel
6. Hand wheel grinding wheel Y axis
7. Hydraulic power unit
8. Transverse carriage
9. Hand wheel carriage Z axis
10. Base
11. Hand wheel table X axis
12. Coolant return line
13. Table
14. Grinding disc
15. Splash guard
16. Cover for grinding wheel
17. Column

Model	FSM 3060	FSM 4080
Art. no.	3933060	3934080
€ plus VAT	27.800,00	38.990,00
Technical specifications		
Size of clamping plate	300 x 600 mm	400 x 800 mm
max. distance between distance and table	500 mm	550 mm
Traversing speed of table	5-25 m/min.	5-25 m/min.
Max. workpiece weight	215 kg	250 kg
Spindle speed	1 450 rpm	1 450 rpm
Size of grinding wheel	355 x 38 x 127 mm	406 x 50 x 127 mm
Spindle motor output	3.75 kW	3.75 kW
Hydraulic pump motor output	0.75 kW	1.5 kW
Electrical connection	400 V / 50 Hz	400 V / 50 Hz
Dimensions (L x W x H)	2 650 x 1 550 x 1 800 mm	3 450 x 2 050 x 1 900 mm
Weight	1 700 kg	3 250 kg

Precision surface grinders

FSM – Precision grinding machines with NC controlled vertical feed



- ➔ Grinding area: 500 x 1 000 mm
- ➔ Grinding wheel: 405 x 50 x 127 mm
- ➔ Max. workpiece weight: 515 kg

FSM 50100



- ➔ Grinding area: 600 x 1 500 mm
- ➔ Grinding wheel: 405 x 50 x 127 mm
- ➔ Max. workpiece weight: 880 kg













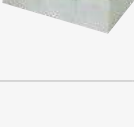

FSM 60150

More models on request!

Model	FSM 50100	FSM 60150	FSM 70200
Art. no.	3935010	3936015	3937020
Technical specifications			
Size of clamping plate	500 x 1 000 mm	600 x 1 500 mm	700 x 2 000 mm
max. distance between distance and table	600 mm	600 mm	600 mm
Traversing speed of table	5-25m/min	5-25 m/min.	5-25 m/min.
Max. workpiece weight	515 kg	880 kg	880 kg
Spindle speed	1 450 rpm	1 450 rpm	1 450 rpm
Size of grinding wheel	405 x 50 x 127 mm	405 x 50 x 127 mm	405 x 50 x 127 mm
Spindle motor output	7.46 kW	7.46 kW	7.46 kW
Hydraulic pump motor output	2.24 kW	3.73 kW	3.73 kW
Electrical connection	400 V / 50 Hz	400 V / 50 Hz	400 V / 50 Hz
Dimensions (L x W x H)	4 600 x 2 300 x 2 040 mm	4 800 x 2 450 x 2 040 mm	6 000 x 2 550 x 2 040 mm
Weight	6 000 kg	7 500 kg	9 000 kg

* Please turn over for descriptions of the packaging surcharges, data on TPFR excluding VAT.

Accessories for precision surface grinders FSM

	FSM 2550 Art no. 3932550	FSM 3060 Art no. 3933060	FSM 4080 Art no. 3934080		FSM 2550 Art no. 3932550	FSM 3060 Art no. 3933060	FSM 4080 Art no. 3934080
 Extraction unit Art no. 3939012	•			 Angle dresser Art no. 3939020			
Extraction mechanism and cooling system Art no. 3939013	•			 Angle dresser Art no. 3939118			
 Extraction mechanism and cooling system Art no. 3939111		•		 Angle dresser Art no. 3939217			
Magnetic separator and cooling system Art no. 3939014	•			Radius dresser Art no. 3939021	•		
 Magnetic separator and cooling system Art no. 3939112		•		 Radius dresser Art no. 3939119		•	
Magnetic separator and cooling system Art no. 3939211			•	 Radius dresser Art no. 3939218			•
Automatic paper belt filter and cooling system Art no. 3939015	•			Toolmaker's vice Art no. 3939022	•		
 Automatic paper belt filter and cooling system Art no. 3939113		•		 Toolmaker's vice Art no. 3939120		•	
Automatic paper belt filter and cooling system Art no. 3939212			•	Toolmaker's vice Art no. 3939219			•
Automatic paper belt filter with magnetic separator and cooling system Art no. 3939016	•			Sinus grinding machine vice Art no. 3939023	•		
 Automatic paper belt filter with magnetic separator and cooling system Art no. 3939114				 Sinus grinding machine vice Art no. 3939121		•	
Automatic paper belt filter with magnetic separator and cooling system Art no. 3939213				Sinus grinding machine vice Art no. 3939121			•
				Shape dresser Art no. 3939024	•		
				 Shape dresser Art no. 3939122		•	
				 Shape dresser Art no. 3939221			•

The FSM series models are equipped with automatic feed control (AD 5). Various grinding cycles are available – see diagram on right. The grinding wheel feed can be individually configured to match the workpiece. The overall grinding dimension is divided into rough and fine feed areas; the feed steps can be freely entered with a minimum resolution of up to 0.001 mm depending on the application. The ability to program idle movements after a certain number of feed steps, and cycles for surface finishing after reaching the grinding dimension guarantees excellent grinding results.

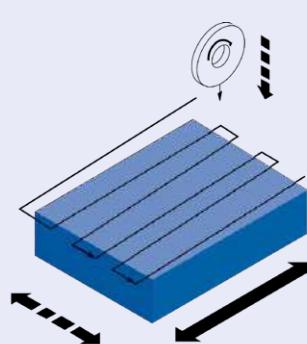

Surface grinding with feed at start point

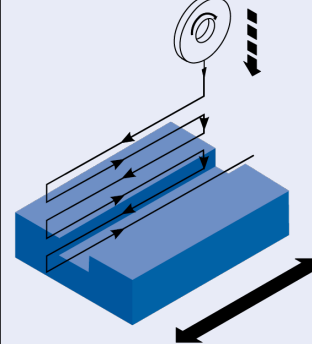



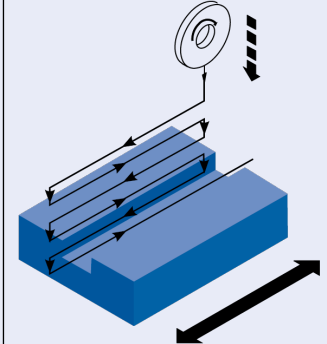





Groove grinding with feed at start point



Groove grinding with feed at start and end point

Precision surface grinders

Accessories for FSM precision surface grinders (ex works only)

Model	FSM 2550 Art no. 3932550	FSM 3060 Art no. 3933060	FSM 4080 Art no. 3934080	Model	FSM 2550 Art no. 3932550	FSM 3060 Art no. 3933060	FSM 4080 Art no. 3934080
Permanent magnet clamping plate 250 x 500 mm Art no. 3939001	•			Ball screw for transverse feed Art no. 3939104 €535.00 plus VAT		•	
Electro-magnetic clamping plate Fine pol. 250 x 500 mm Art no. 3939002	•			Fine adjustment for vertical feed Art no. 3939007 €749.00 plus VAT	•		
 Electro-magnetic clamping plate Fine pol. 300 x 600 mm Art no. 3939101		•		Fine adjustment for vertical feed Art no. 3939106		•	
Electro-magnetic clamping plate Fine pol. 400 x 800 mm Art no. 3939201			•	Fine adjustment for vertical feed Art no. 3939206			•
NC controlled parallel dressing and equalising unit Art no. 3939003	•			Vertical rapid motion Art no. 3939008	•		
NC controlled parallel dressing and equalising unit Art no. 3939102		•		 Vertical rapid motion Art no. 3939107		•	
NC controlled parallel dressing and equalising unit Art no. 3939203			•	Vertical rapid motion Art no. 3939207			•
Parallel dressing unit hydraulic Art no. 3939202			•	Rear splash guard Art no. 3939009	•		
Automatic adjustment of transverse feed Art no. 3939004	•			 Rear splash guard Art no. 3939108		•	
 Automatic adjustment of transverse feed Art no. 3939103		•		Rear splash guard Art no. 3939208 €945.00 plus VAT			•
Automatic adjustment of transverse feed Art no. 3939204			•	Splash guard front and sides Art no. 3939010 €859.00 plus VAT	•		
Fine adjustment for transverse feed Art no. 3939006	•			 Splash guard front and sides Art no. 3939109		•	
Fine adjustment for transverse feed Art no. 3939105		•		Splash guard front and sides Art no. 3939209			•
Fine adjustment for transverse feed Art no. 3939205			•	Full splash guard Art no. 3939018	•		
				 Full splash guard Art no. 3939116		•	
				Full splash guard Art no. 3939215			•
				 Automatic balancing device Art no. 3939117		•	
				 Automatic balancing device Art no. 3939216			•

More accessories on request.



Cutting/shears

Circular shears/Guillotine shears

KS – circular shears for steel up to 2.0 mm

- ▶ Suitable for cutting metals, cardboard and other materials
- ▶ Extremely stable and rugged design made of cast iron
- ▶ Knives made of cold-worked steel K2379, bronze bearings
- ▶ Hardened, regrindable knives

- KS 2**
- ▶ motorised
 - ▶ Motor brake
 - ▶ Central lubrication
 - ▶ Inner diameter cutting system
 - ▶ Mobile control panel with foot pedal



KS 1



KS 2

Model	KS 1	KS 2
Art. no.	3811001	3811002
Technical specifications		
Max. cutting diameter	1 000 mm	1 000 mm
Max. cutting thickness	1.0 mm	2 mm
Cutting speed	-	7.5 m/min.
Motor output	-	1.1 kW
Electrical connection	-	400 V / 50 Hz
Throat depth	600 mm	700 mm
Throat	200 mm	280 mm
Weight	45 kg	350 kg
Dimensions (L x W x H)	1 200 x 200 x 350 mm	1 400 x 400 x 1 150 mm

Performance data for material with tensile strength of 400 N/mm²

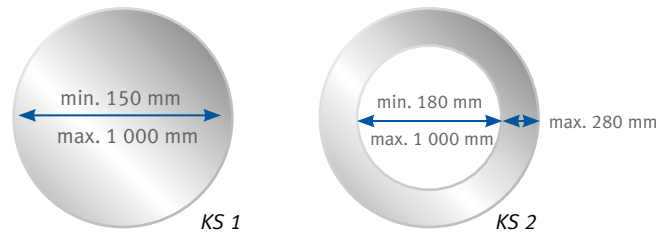

KS 1

KS 2

Accessories KS 1	Art. no.
Set of spare blades	3880150

Accessories KS 2	Art. no.
Set of spare blades	3880156

BSS 1000 – Guillotine shears for sheet metal, paper and other materials, foldable chassis

- ▶ Ideal for craftsmen on the road
- ▶ Stable and robust design
- ▶ Compact dimensions due to foldable chassis
- ▶ Easy to transport
- ▶ For steel sheet up to 1.2 mm and rolls with a width of up to 1 020 mm
- ▶ The standard blank holder ensures good cutting results
- ▶ Optimal price-performance ratio



BSS 1000
with foldable chassis



Model	BSS 1000
Art. no.	3741100

Technical specifications	
Max. cutting width	1 020 mm
Max. sheet thickness*	1.20 mm
Dimensions (L x W x H)	1 830 x 550 x 1 225 mm
Weight	97 kg

*Performance data for material with tensile strength of 400 N/mm²

Accessories	Art. no.
Lateral stop BSS 1000	3760110
Replacement knife BSS 1000	3760111

BSS – Manual guillotine shears, heavy-duty type

- ▶ For steel sheet up to 1.5 mm and rolls with a width of up to 1 250 mm
- ▶ Extremely stable and heavy design made of cast iron
- ▶ Open construction type
- ▶ Large cast work table
- ▶ Standard blank holder ensures good cutting results
- ▶ Removable mitre stop on work table
- ▶ Lateral stop adjustable via crank
- ▶ Optimal price-performance ratio



BSS
Manual guillotine shears

Model	BSS 1020 E	BSS 1250 E
Art. no.	3816001	3816002
Technical specifications		
Max. cutting width	1 050 mm	1 250 mm
Max. sheet thickness*	1.50 mm	1.50 mm
Stop area	0 - 600 mm	0 - 600 mm
Rear stop width	790 mm	790 mm
Work table	600 x 1280	600 x 1 530
Dimensions in mm	2 000 x 850 x 1 500	2 450 x 1 000 x 1 820
Weight	435 kg	490 kg

*Performance data for material with tensile strength of 400 N/mm²

Accessories	Art. no.
Replacement knife BSS 1020	3880300
Replacement knife BSS 1250	3880301

TBS – Manual precision sheet metal shears

- ▶ For cutting metals, paper, plastic and other materials
- ▶ Mitre stop on front
- ▶ Tempered knife
- ▶ Rear stop with scale

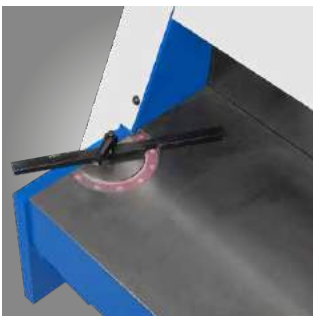

TBS
Manual precision guillotine shears

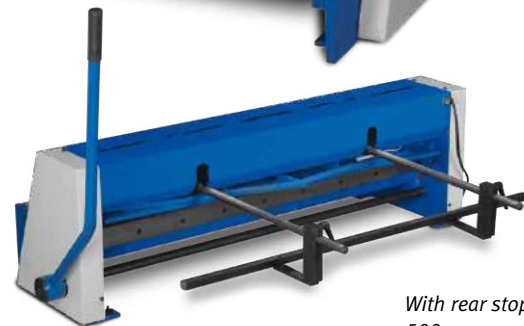

With rear stop
500 mm as standard

Model	TBS 650-12 T	TBS 1050-10 T
Art. no.	3776165	3776111
Technical specifications		
Max. working width	650 mm	1 050 mm
Max. sheet thickness*	1.25 mm	1.00 mm
Rear stop area	0 - 500 mm	0 - 500 mm
Weight	100 kg	160 kg
Dimensions (L x W x H)	970 x 470 x 540 mm	1 370x 480 x 580 mm

*Performance data for material with tensile strength of 400 N/mm²

Accessories	Art. no.
Standard knife TBS 650-12 T	3760065
Standard knife TBS 1050-10 T	3761050

Guillotine shears

Manual sheet metal shears TBS – suitable for cutting steel, non-ferrous metals and plastics

- ▶ Suitable for cutting steel, aluminium and copper
- ▶ Premium knife made of steel with a hardness of HRC55-60
- ▶ Equipped with two operating handles
- ▶ Front support surface with scale
- ▶ Rear stop adjustable up to 300 mm



Features

- > Rear stop
- > Two control handles

Model		TBS 1501-15	TBS 2001-12
Art. no.		3746015	3746020

Technical specifications			
Max. working width	mm	1 500	2000
Sheet thickness (400 N/mm ²) max.*	mm	1.5	1.25
Sheet thickness (700 N/mm ²) max.	mm	0.75	0.62
Rear stop adjustment range up to	mm	300	
Rear stop width	mm	485	
Table height	mm	800	
Length x width x height	mm	1 950 x 1 100 x 1 050	2 450 x 1 100 x 1 050
Weight	kg	445	511

Accessories	Art. no.
Replacement knife set TBS 1501-15	3746910
Replacement knife set TBS 2001-12	3746911
Special knife set for cutting stainless steel TBS 1501-15	3746915
Special knife set for cutting stainless steel TBS 2001-12	3746916

Sheet metal shears with foot pedal FTBS 1050-10 – suitable for cutting metals and non-ferrous metals

- ▶ Stable and rugged welded design
- ▶ Foot operation means that both hands are free for feeding in the material
- ▶ Premium knife
- ▶ Angle-adjustable side stop with millimetre scale
- ▶ Maximum safety thanks to hold down unit which also protects the fingers.
- ▶ Rear stop adjustable up to 500 mm

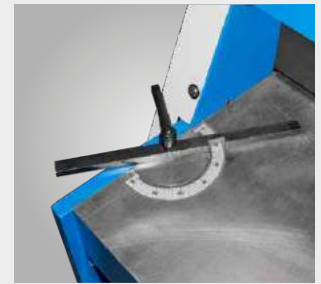

▶ Angle-adjustable side stop with millimetre scale

Features

- > Rear stop
- > Angle-adjustable side stop with millimetre scale
- > Foot pedal

Model		FTBS 1050-10
Art. no.		3772910

Technical specifications		
Working width	mm	1 050
Sheet thickness (400 N/mm ²) max.	mm	1.00
Rear stop adjustment range up to	mm	500
Length x width x height	mm	1 160 x 730 x 930
Weight	kg	175

Accessories	Art. no.
Replacement knife FTBS 1050-10	3772911

Guillotine shears

FTBS M – Manually supported sheet metal shears with foot operation.
Universally deployable in industrial and trade applications



- ▶ Stable, rugged welded design
- ▶ Suitable for cutting metals and non-ferrous metals
- ▶ Foot operation means that both hands are free for feeding in the material
- ▶ Generously dimensioned Plexiglas view window
- ▶ Premium steel blade bar
- ▶ Slotted guide system
- ▶ Easy adjustment of the knife via eight screws
- ▶ Angle-adjustable side stop with millimetre scale
- ▶ Cutting line lighting as standard
- ▶ Optimal price-performance ratio



▶ Angle-adjustable side stop (included in scope of supply)

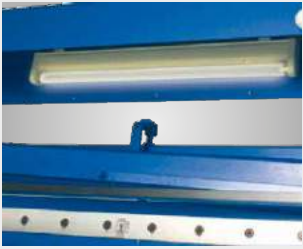

▶ With cutting line lighting as standard



▶ With rear stop as standard



FTBS 1300-12 M

FTBS M - Manual foot-operated guillotine shears

Model	FTBS 1050-12 M	FTBS 1300-12 M
Art. no.	3753012	3753013
Technical specifications		
Max. working width	1 030 mm	1 300 mm
Max. sheet thickness*	1.25 mm	1.25 mm
Cutting angle	3°	3°
Rear stop	550 mm	550 mm
Lateral stop	200 mm	200 mm
Cuts per min.	-	-
Weight	148 kg	200 kg
Dimensions L x W x H	1 380 x 880 x 1 300	1 790 x 510 x 1 290

*Performance data for material with tensile strength of 400 N/mm²

Accessories	Art. no.
Replacement knife FTBS 1050-12 M	3760312
Replacement knife FTBS 1300-12 M	3760313

FTBS P – Pneumatic sheet metal shears

Universally deployable in industrial and trade applications



- ▶ P version with 2 pneumatic servo-cylinders and footswitch
- ▶ Stable and rugged welded design
- ▶ Suitable for cutting metals and non-ferrous metals
- ▶ Foot operation means that both hands are free for feeding in the material
- ▶ generously dimensioned Plexiglas view window
- ▶ Premium steel knife
- ▶ Slotted guide system
- ▶ Easy adjustment of the knife via eight screws
- ▶ Angle-adjustable side stop with millimetre scale
- ▶ Cutting line lighting as standard
- ▶ Optimal price-performance ratio



FTBS 1050-15 P

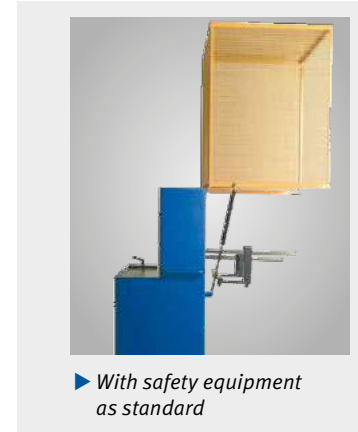

FTBS P - pneumatic foot-operated guillotine shears

Model	FTBS 1050-15 P	FTBS 1050-20 P	FTBS 1300-15 P	FTBS 1300-20 P
Art. no.	3754015	3754020	3755015	3755020
Technical specifications				
Max. working width	1 030 mm	1 030 mm	1 330 mm	1 330 mm
Max. sheet thickness*	1.50 mm	2.00 mm	1.50 mm	2.00 mm
Cutting angle	3°	3°	3°	3°
Rear stop	550 mm	550 mm	550 mm	550 mm
Lateral stop	200 mm	200 mm	200 mm	200 mm
Cuts per min.	22	15	21	14
Weight	270 kg	280 kg	300 kg	310 kg
Dimensions L x W x H	1 490 x 1 250 x 1 290	1 490 x 1 250 x 1 290	1 790 x 1 250 x 1 290	1 790 x 1 250 x 1 290

*Performance data for material with tensile strength of 400 N/mm² **Please turn over for descriptions of the transport surcharges. Price TPFR plus VAT

Accessories	Art. no.
Replacement blade FTBS 1050	3760312
Replacement blade FTBS 1300	3760313
Replacement blade FTBS 2000	3760314

Motorised guillotine shears

MTBS – Motorised guillotine shears

- ▶ Stable and rugged welded design
- ▶ Suitable for cutting metals and non-ferrous metals
- ▶ Premium blades
- ▶ Angle-adjustable side stop with millimetre scale
- ▶ Maximum safety thanks to hold down unit which also protects the fingers.
- ▶ 500 mm rear stop



Angle-adjustable side stop with millimetre scale



MTBS 1050-10
With optional chassis



Scope of delivery:

- › Rear stop 0 - 500 mm
- › Angle stop with millimetre scale
- › Protective grille

Model	MTBS 1050-10
Art. no.	3772915

Technical specifications	
Working width	1 050 mm
Max. sheet thickness*	1.00 mm
Rear stop	500 mm
Strokes per minute	55
Motor output	0.75 kW
Electrical connection	400 V / 50 Hz
Dimensions	1 400 x 65 x 650 mm
Weight	238 kg

*Performance data for material with tensile strength of 400 N/mm²

Accessories	Art. no.
Replacement knife MTBS 1050-10	3772916
Chassis MTBS 1050-10	3772917

MTBS E – Motorised guillotine shears

- ▶ Heavy-duty, stress-free welded steel design
- ▶ Premium knife
- ▶ Two long sheet support arms for large workpieces
- ▶ Manual rear stop 630 mm with adjustment option with millimetre precision
- ▶ Cutting line lighting and slots in upper cover plate for an optimum view of the cutting edge and for cutting along marks
- ▶ Light barrier for rear stop area
- ▶ Foot operation means that both hands are free for feeding in the material



MTBS 1255-30 E

Scope of delivery:

- › Sheet support arms
- › Lateral stop
- › Manual rear stop
- › Foot-operated

Model	MTBS 1255-30 E	MTBS 1255-40 E	MTBS 2055-30 E	Replacement blade	Art. no.
Art. no.	3757013	3757014	3757023	MTBS 1255-30 E	3757910
				MTBS 1255-40 E	3757911
				MTBS 2055-30 E	3757912
Technical specifications				Special knife set for cutting stainless steel	Art. no.
Working width	1 250 mm	1 250 mm	2 050 mm	MTBS 1255-30 E	3757920
Sheet thickness (400 N/mm ²) max.*	3 mm	4 mm	3 mm	MTBS 1255-40 E	3757921
Sheet thickness (700 N/mm ²) max.	1.5 mm	2 mm	1.5 mm	MTBS 2055-30 E	3757922
Cutting angle	2°	2.4°	2°		
Number of sheet support arms	2 units	2 units	3 units		
Rear stop adjustment range up to	630 mm	630 mm	630 mm		
Strokes per min.	30	30	30		
Motor output 400 V / 50 Hz	3 kW	4 kW	4 kW		
Weight	850 kg	1 185 kg	1 520 kg		
Dimensions (L x W x H) mm	1 682 x 1 477 x 1 100	1 712 x 1 605 x 1 190	2 495 x 1 610 x 1 190		

*Performance data for material with tensile strength of 400 N/mm²; cutting capacity stainless: factor 0.5

Technical and visual changes reserved



Motorised guillotine shears

MTBS B – Motorised sheet metal shears with NC-controlled rear stop

- ▶ Heavy-duty, rugged welded design
- ▶ Slot-guided top beam with adjustable flat guides
- ▶ Manual cutting kerf adjustment
- ▶ LED cutting line lighting and slots in upper cover for an optimum view of the cutting edge and for cutting along marks
- ▶ Transfer roller bearings on support table for convenient material handling
- ▶ Solid 90° lateral stop with length of 1 000 mm, T-slot, tilting cam and scale
- ▶ Two solid sheet support arms with T-slots and tilting cams
- ▶ Motorised, NC-controlled rear stop, 750 mm travel range
- ▶ Rear stop drive with frequency inverter, brake motor and ball screws
- ▶ Premium rotatable knife, suitable for cutting stainless steel
- ▶ Heavy hold-down bar with rubber inserts to protect the material
- ▶ Rear area protected by light curtain
- ▶ Operated via mobile foot pedal console with emergency stop



- Electrical adjustment of rear stop
- Motor on
- Emergency stop switch
- Selector switch for setup or normal operation
- Setup operation blade beam up
- Warning light for light barrier
- Setup operation blade beam down
- Work lamp on/off
- Main switch



MTBS 1350-30 B
(with optional small parts chute and drawer)

Technical specifications	MTBS 1350-30 B	MTBS 1540-40 B	MTBS 2100-40 B	MTBS 2550-40 B	MTBS 3130-30 B
Art. no.	3815513	3815515	3815520	3815525	3815530
Max. working width	1 350 mm	1 540 mm	2 050 mm	2 550 mm	3 050 mm
Sheet thickness (400 N/mm ²)	3.0 mm	4.0 mm	4.0 mm	4.0 mm	3.0 mm
Sheet thickness (700 N/mm ²)	1.5 mm	2.5 mm	2.5 mm	2.5 mm	1.5 mm
Rear stop	750 mm	750 mm	750 mm	750 mm	750 mm
Cutting angle	2.2°	2.0°	1.8°	1.8°	1.5°
Cuts per min.	40	40	38	38	38
Motor output 400 V / 50 Hz	3 kW	5.5 kW	7.5 kW	7.5 kW	7.5 kW
Weight	1 150 kg	2 200 kg	2 600 kg	3 000 kg	3 600 kg
Dimensions (L x W x H) mm	1 920 x 1 920 x 1 110	2 170 x 2 160 x 1 280	2 730 x 2 160 x 1 280	3 170 x 2 160 x 1 280	3 760 x 2 160 x 1 280



MTBS 2100-40 B
(with optional small parts chute and drawer)



MTBS 2100-40 B (with optional thin sheet holding device)

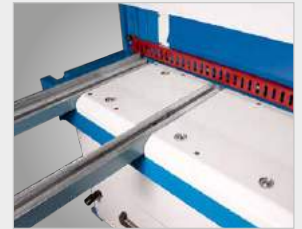

Work table with support arms and transfer roller bearings



Cutting line lighting and view slots



Drawer



Pneumatic thin sheet support device



Small parts chute

Options (only available ex works)	Art. no.
Small parts flap for discharge towards front with drawer (max. 300 x 300 mm)	3887200
Pneumatic thin sheet support device	3887201
Central lubrication via manual pump	3887210
Extension of motorised rear stop from 750 mm to 1 000 mm	3887211

Accessories	Art. no.
Adjustable angle stop 0-180°	3887220

Replacement blade kit	Art. no.
Replacement knife set MTBS 1350-30 B	3887240
Replacement knife set MTBS 1540-40 B	3887241
Replacement knife set MTBS 2100-40 B	3887242
Replacement knife set MTBS 2550-40 B	3887243
Replacement knife set MTBS 3130-30 B	3887244

Motorised sheet metal shears

MTBS – Motorised sheet metal shears, heavy-duty type, foot-operated

Standard type

- ▶ Heavy-duty, stress-free welded steel design
- ▶ Low-noise cutting operation thanks to brake motor and gear unit
- ▶ Motorised rear stop 750 mm (MTBS-D)
- ▶ Rear stop drive with play-free ball screws and linear guides (MTBS-D)
- ▶ Manual rear stop 550 mm (MTBS)
- ▶ All moving parts with low-maintenance bearings
- ▶ Premium rotatable knife, suitable for cutting stainless steel
- ▶ Digital position display for motorised rear stop (MTBS-D)
- ▶ Cutting kerf adjustment on the front of the machine (MTBS-D)
- ▶ Slot guided upper beam
- ▶ Operated via mobile foot switch with emergency stop switch
- ▶ Rear stop area safeguarded by light barrier
- ▶ Hold-down bar with plastic inserts
- ▶ Lateral stop with scale and 2 sheet support arms



- Electrical adjustment of rear stop
- Selector switch for setup or normal operation
- Motor on
- Motor off
- Mains power indicator
- Main switch

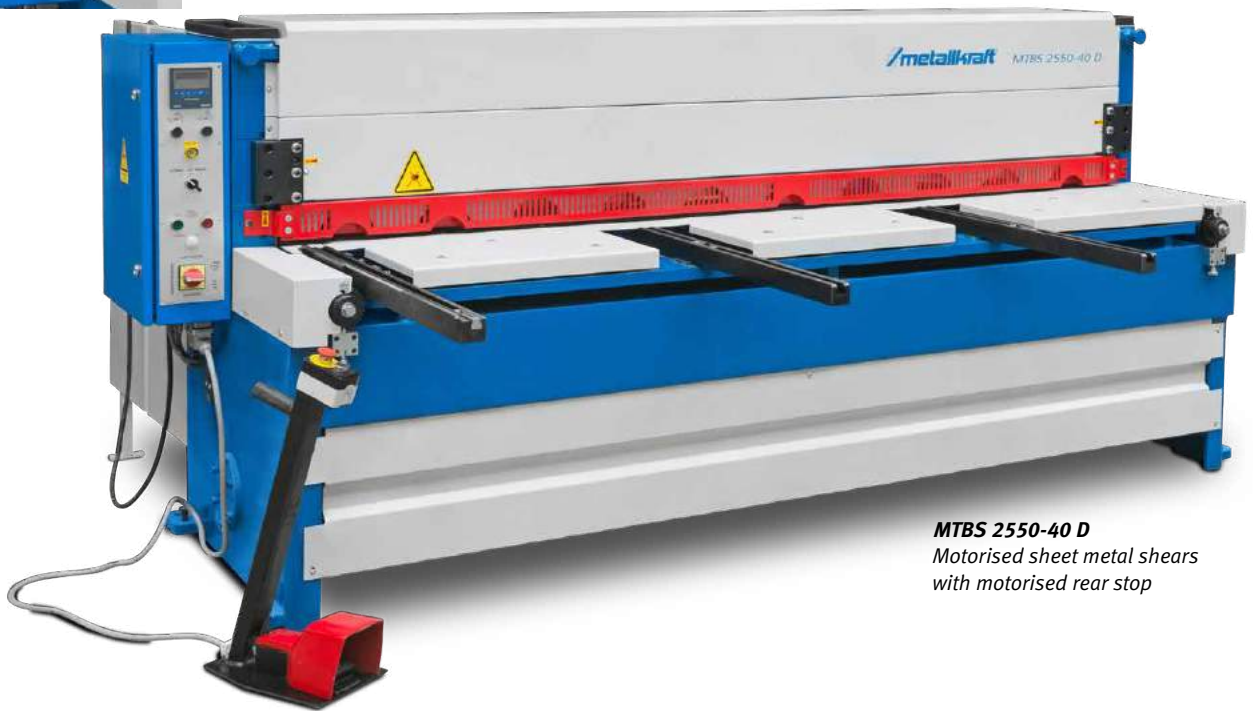

MTBS 2550-40 D
Motorised sheet metal shears
with motorised rear stop

MTBS - motorised sheet metal shears with manual rear stop

Technical specifications	Max. working width	Max. sheet thickness*	Cutting angle	Rear stop	Cuts per min.	Motor output	Weight	Dimensions LxWxH	Art. no.
MTBS 1350-30	1 350 mm	3.0 mm	2° 30'	550 mm	35	3.0 kW	1 100 kg	1 920 x 1 350 x 1 200	3815101
MTBS 2050-30	2 050 mm	3.0 mm	2° 12'	550 mm	35	3.0 kW	1 300 kg	2 400 x 1 350 x 1 200	3815102
MTBS 2550-25	2 550 mm	2.5 mm	1° 30'	550 mm	35	3.0 kW	1 400 kg	2 860 x 1 350 x 1 200	3815103

MTBS D - motorised guillotine shears with motorised rear stop

Technical specifications	Max. working width	Max. sheet thickness*	Cutting angle	Rear stop	Cuts per min.	Motor output	Weight	Dimensions LxWxH	Art. no.
MTBS 2050-40 D	2 050 mm	4.0 mm	1° 30'	750 mm	42	7.5 kW	2 800 kg	2 550 x 2 260 x 1 330	3815201
MTBS 2550-40 D	2 550 mm	4.0 mm	1° 30'	750 mm	42	7.5 kW	3 230 kg	3 050 x 2 260 x 1 330	3815202
MTBS 3100-40 D	3 100 mm	4.0 mm	1° 30'	750 mm	42	7.5 kW	3 730 kg	3 650 x 2 260 x 1 330	3815203

*Performance data for material with tensile strength of 400 N/mm²

Custom accessor

- ▶ Pneumatic thin sheet support device
- ▶ Motorised rear stop (standard with MTBS-D)
- ▶ NC control for motorised rear stop (MTBS-D)
- ▶ Motorised rear stop 1 000 mm
- ▶ Cutting line lighting (MTBS-D)
- ▶ Mitre stop
- ▶ Extended lateral stop with sheet support arms



Option *

NC controller D-Touch 7 for MTBS

- ▶ Unlimited program and single cut definitions
- ▶ Automatic machine stop on reaching the programmed cuts
- ▶ Display of completed and programmed steps



MTBS 2050-30
Motorised guillotine shears with manual rear stop

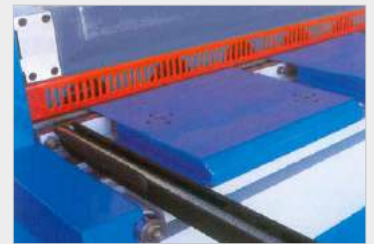

- ▶ Support table with ball transfer units ensure easy feeding that is gentle on the material (MTBS-D)

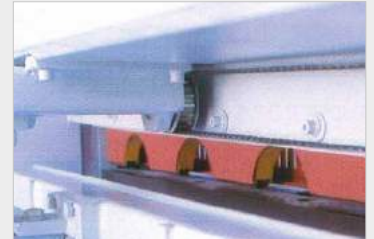

- ▶ Motorised rear stop 750 mm (optionally also with 1 000 mm MTBS-D)



- ▶ The pneumatic thin sheet support device prevents the sheet bending after the cutting edge when cutting thin material and thus guarantees maximum stop precision (optional)



- ▶ Manual rear stop with adjustment option with millimetre precision (MTBS)

Accessories	Art. no.
Replacement knife MTBS 1350-30	3880036
Replacement knife MTBS 2050-30	3880037
Replacement knife MTBS 2550-25	3880038
Replacement blade MTBS 2050-40 D	3880046
Replacement blade MTBS 2550-40 D	3880047
Replacement blade MTBS 3100-40 D	3880048

Accessories for MTBS 2050-40 D, MTBS 2550-40 D, MTBS 3100-40 D	Art. no.
Lateral stop with T grooves, scale and tilt stop 2 000 mm	3880001
Lateral stop with T grooves, scale and tilt stop 3 000 mm	3880002
Side stop extension 2 000 mm	3880003
Side stop extension 3 000 mm	3880004
Angle-adjustable side stop 0-180°	3880005

Surcharge for optional equipment	Art. no.
Pneumatic thin sheet support device for	
MTBS 1350	3880006
MTBS 2050/ MTBS 2050 D	3880007
MTBS 2550/ MTBS 2550 D	3880008
MTBS 3100/ MTBS 3100 D	3880009
Motorised rear stop 750 mm with digital display MTBS	3880010
Cutting line lighting for D models (only for 3815201, 3815202 and 3815203)	3880044
Motorised rear stop 1 000 mm for	
for MTBS	3880013
for MTBS D	3880014
NC controller D-Touch 7 for MTBS	3880000

*Optional equipment is not retrofittable

Motorised sheet metal shears

MTBS-T – Motorised sheet metal shears with NC-controlled rear stop, sheet metal discharge at front and rear and manual cutting kerf adjustment

- ▶ Rear stop guided on round shafts, driven via play-free ball screws
- ▶ Positioning control of rear stop Maper HT071 with digital dimension display
- ▶ Heavy and robust welded steel construction
- ▶ Constant, low cutting angle for optimal cutting results
- ▶ Lateral stop 1 000 mm with scale and T-slot
- ▶ 2 material support arms 500 mm with T-slot
- ▶ Balls in support table for easier material transport
- ▶ Cutting kerf adjustment by means of vernier scale rings
- ▶ Premium blade, suitable for stainless steel
- ▶ LED lighting of the cutting area
- ▶ Finger protection device throughout
- ▶ Mobile foot pedal with EMERGENCY OFF switch
- ▶ All moving parts with low-maintenance bearings
- ▶ Electrics by "Siemens" and "Schneider"
- ▶ Operating instructions with CE Declaration of Conformity



scope of delivery MTBS
LED cutting line lighting
Transfer roller bearings on support table
Solid 90° lateral stop with length of 1 000 mm, T-slot, tilting cam and scale
Motorised, NC-controlled rear stop, 750 mm travel range

Technical specifications	MTBS 1350-30 T	MTBS 1540-40 T	MTBS 2100-40 T	MTBS 2550-40 T	MTBS 3130-30 T	MTBS 3130-40 T
Art. no.	3815613	3815615	3815620	3815625	3815630	3815631
Working width	1 320 mm	1 530 mm	2 090 mm	2 530 mm	3 100 mm	3 080 mm
Sheet thickness (450 N/mm ²)	3 mm	4 mm	4 mm	4 mm	3 mm	4 mm
Sheet thickness (700 N/mm ²)	1.5 mm	2.5 mm	2.5 mm	2.5 mm	1.5 mm	2.5 mm
Rear stop travel range	600 mm	750 mm	750 mm	750 mm	750 mm	750 mm
Rear stop speed	28 mm/s	28 mm/s	28 mm/s	28 mm/s	28 mm/s	28 mm/s
Side stop length	1 000 mm	1 000 mm	1 000 mm	1 000 mm	1 000 mm	1 000 mm
Cutting angle	2.2°	2°	1.8°	1.8°	1.5°	1.5°
Cuts per min.	40	40	38	38	38	38
Number of sheet support arms	2 units	2 units	2 units	2 units	3 units	3 units
Cutting kerf adjustment min.	0.05 mm	0.05 mm	0.05 mm	0.05 mm	0.05 mm	0.05 mm
Cutting kerf adjustment max.	0.3 mm	0.4 mm	0.4 mm	0.4 mm	0.3 mm	0.4 mm
Motor output rear stop	0.37 kW	0.37 kW	0.37 kW	0.37 kW	0.37 kW	0.37 kW
Output 400 V / 50 Hz	3 kW	5.5 kW	7.5 kW	7.5 kW	7.5 kW	7.5 kW
Dimensions (L x W x H) in mm	2 070 x 2 120 x 1 110	2 320 x 2 360 x 1 280	2 880 x 2 360 x 1 280	3 320 x 2 360 x 1 280	3 910 x 2 360 x 1 280	3 910 x 2 500 x 1 500
Weight	1 190 kg	2 240 kg	2 650 kg	3 050 kg	3 660 kg	5 000 kg

*Performance data for material with tensile strength of 400 N/mm²; cutting capacity VA steel: factor 0.5



MTBS 2550-40 T

Factory options	Art. no.
Central lubrication via manual pump	3887210
Extension of motorised rear stop from 750 mm to 1 000 mm	3887211

Accessories	Art. no.
Adjustable angle stop 0-180°	3887220

Replacement blade kit	Art. no.
For MTBS 1350-30 T	3887240
For MTBS 1540-40 T	3887241
For MTBS 2100-40 T	3887242
For MTBS 2550-40 T	3887243
For MTBS 3130-30 T	3887244
For MTBS 3130-40 T	3887245

Mobile sheet stacker truck up to 300 kg	Art. no.
For MTBS 1350-30 T	3887225
For MTBS 1540-40 T	3887226
For MTBS 2100-40 T	3887227
For MTBS 2550-40 T	3887228
For MTBS 3130-30 T	3887229
For MTBS 3130-40 T	3887229

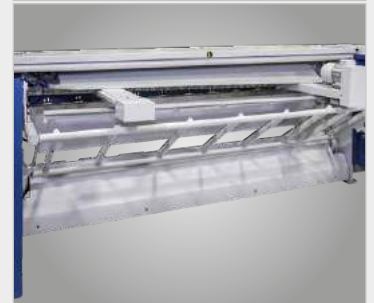
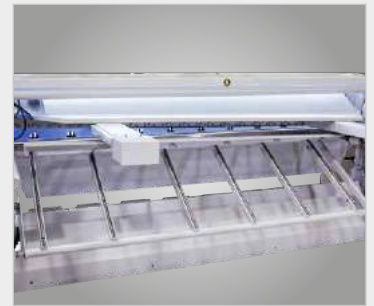

► Pneumatic sheet holder with selection lever for the sheet shoot direction. The user can select whether the cut-off is discharged to the rear or operator side



► Rear area safeguards to CE standard with side panels and light barrier



► Control panel of left side of machine



► Selection lever for sheet discharge at front or rear

Hydraulic swing cut guillotine shears

HTBS-T – Hydraulically NC-controlled sheet metal shears, heavy-duty type

Standard type

- ▶ Very heavy welded steel design
- ▶ Low cutting angle for optimum results
- ▶ Motorised rear stop 1 000 mm
- ▶ Rear stop driven via play-free ball screws, guided on linear rails
- ▶ Rear stop easily positioned via NC controller D-Touch 7
- ▶ Fold-up, split finger protection guard 1 000 mm
- ▶ Ergonomically arranged, pivoting control panel

- ▶ Operated via mobile foot switch with emergency stop switch
- ▶ Manual cutting kerf adjustment via lever with scale on right side of machine
- ▶ Rear stop area safeguarded by light barrier
- ▶ Lighting with cutting line display
- ▶ Blank holder arranged close to cutting edge
- ▶ Easy handling of sheet metal via ball transfer units in table

- ▶ One angle stop 1 500 mm and two sheet support arms 1 000 mm (three sheet support arms for machines as of 4 m)
- ▶ Premium rotatable knife, suitable for cutting stainless steel
- ▶ Premium components by Bosch, Rexroth, Hydac, Siemens, Telemecanique



HTBS-T 3100-60
Hydraulic sheet metal shears

Model	HTBS-T 3100-60	HTBS-T 3100-100	HTBS-T 3100-130	HTBS-T 3100-160	HTBS-T 4100-60	HTBS-T 4100-130
Art. no.	3825306	3825310	3825313	3825316	3825406	3825413

Technical data	HTBS-T 3100-60	HTBS-T 3100-100	HTBS-T 3100-130	HTBS-T 3100-160	HTBS-T 4100-60	HTBS-T 4100-130
Cutting length (A)	3 100 mm	3 100 mm	3 100 mm	3 100 mm	4 100 mm	4 100 mm
Cutting performance (450 N/mm ²)	6 mm	10 mm	13 mm	16 mm	6 mm	13 mm
Cutting performance (700 N/mm ²)	4 mm	6 mm	8 mm	10 mm	4 mm	8 mm
Stand throat (D)	50 mm	50 mm	50 mm	50 mm	50 mm	50 mm
max. strokes per minute for full cutting length	15	13	13	10	12	8
Cutting angle	1.30°	1.30°	1.45°	2°	1.30°	1.45°
Cutting kerf adjustment min.	0.05 mm	0.05 mm	0.05 mm	0.07 mm	0.05 mm	0.05 mm
Cutting kerf adjustment max.	0.75 mm	1.05 mm	1.45 mm	1.80 mm	0.75 mm	1.45 mm
Table height (C)	865 mm	865 mm	845 mm	818 mm	865 mm	818 mm
Table depth (B)	500 mm	580 mm	600 mm	550 mm	580 mm	550 mm
Table length (R)	3 515 mm	3 515 mm	3 550 mm	3 580 mm	4 510 mm	4 620 mm
Number of blank holders	16	16	16	14	20	18
Blank holder pressure	14 t	22 t	37 t	61 t	17 t	62 t
Rear stop adjustment range	1 000 mm	1 000 mm	1 000 mm	1 000 mm	1 000 mm	1 000 mm
Motor output rear stop	0.75 kW	0.75 kW	0.75 kW	0.75 kW	0.75 kW	0.75 kW
Rear stop speed	120 mm/sec.	120 mm/sec.	120 mm/sec.	120 mm/sec.	120 mm/sec.	120 mm/sec.
Driving power	15 kW	22 kW	30 kW	37 kW	15 kW	30 kW
Electrical connection	400 V / 50 Hz	400 V / 50 Hz	400 V / 50 Hz	400 V / 50 Hz	400 V / 50 Hz	400 V / 50 Hz
Oil tank capacity	200 l	200 l	330 l	410 l	200 l	330 l
Number of sheet support arms	2	2	2	2	3	3
Length (L)	4 110 mm	4 200 mm	4 280 mm	4 550 mm	5 230 mm	5 350 mm
Depth (W1)	2 200 mm	2 250 mm	2 300 mm	2 250 mm	2 300 mm	2 250 mm
Overall depth (W)	3 700 mm	3 600 mm	3 600 mm	3 825 mm	3 600 mm	3 850 mm
Height (H)	2 100 mm	2 100 mm	2 350 mm	2 250 mm	2 150 mm	2 250 mm
Weight	7 650 kg	9 300 kg	12 500 kg	15 000 kg	11 750 kg	16 300 kg

All hydraulic sheet metal shears are supplied with oil.

Custom accessor

- ▶ Pneumatic thin sheet support device with one or two levels
- ▶ Motorised cutting kerf adjustment
- ▶ Laser cutting line display
- ▶ Light barrier instead of finger protection grille
- ▶ Removable mitre stop
- ▶ Extended lateral stop with sheet support arms
- ▶ Transfer balls for lateral stop and sheet support arms



(C)NC controller D-Touch 7:

- ▶ Glare-free, rugged 7" colour touchscreen control panel
- ▶ Easy positioning to the desired dimension
- ▶ Unlimited program and single cut definitions
- ▶ Unlimited material definitions in the material library
- ▶ Intuitive menu-guided operation
- ▶ Separate displays for ACTUAL and TARGET values
- ▶ Rear stop move out function
- ▶ Positioning accuracy 0.1 mm
- ▶ Cut length validation via configurable stroke length
- ▶ Cut counter
- ▶ Control of machine accessories (e.g., optional sheet support device) and motorised cutting kerf adjustment

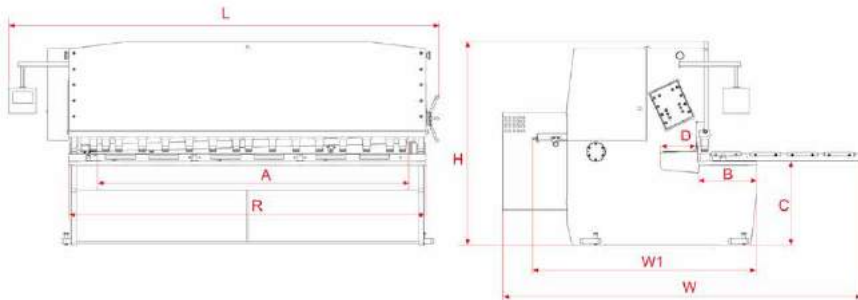

- (A) Cut length
- (B) Table depth
- (C) Working height
- (D) Throat
- (H) Height
- (L) Length
- (W) Depth
- (R) Table length

Accessories	Art. no.	Accessories	Art. no.
Safety light barrier instead of finger protection grille	3883001	Rear stop 1250 mm	3883016
Throat 350 mm HTBS-T 3100-60/4100-60	3883002	Rear stop swivels up hydraulically HTBS-T 3100-160/4100-130	3883017
Throat 350 mm HTBS-T 3100-100/3100-130	3883003	Sheet support arms L=2 m (1 pc.)	3883018
Throat 500 mm HTBS-T 3100-60	3883004	Sheet support arms L=3 m (1 pc.)	3883019
Throat 500 mm HTBS-T 3100-100/HTBS-T 3100-130/ HTBS-T 4100-60	3883005	Sheet support arms extension =2 m (1 pc.)	3883020
Throat 500 mm HTBS-T 3100-160/4100-130	3883006	Sheet support arms L=3 m (1 pc.)	3883021
Pneumatic thin sheet support device "single stage" HTBS-T 3100-60/3100-100/3100-130	3883008	Side stop extension L=2 m (1 pc.)	3883022
Pneumatic thin sheet support device "single stage" HTBS-T 3100-160	3883009	Side stop extension L=3 m (1 pc.)	3883023
Pneumatic thin sheet support device "single stage" HTBS-T 4100-60/4100-130	3883010	Side stop (1 500 mm) on right side	3883024
Pneumatic thin sheet support device "two-level" HTBS-T 3100-60/3100-100	3883011	Balls for support arms/ Side stop price per ball	3883025
Pneumatic thin sheet support device "two-level" HTBS-T 3100-130	3883012	Angle-adjustable side stop 0-180° motorised cutting kerf adjustment for CNC version	3883026
Pneumatic thin sheet support device "two-level" HTBS-T 3100-160	3883013	Laser cutting line	3883027
Pneumatic thin sheet support device "two-level" HTBS-T 4100-60	3883014	1 set replacement blades HTBS-T 3100-60	3883029
Pneumatic thin sheet support device "two-level" HTBS-T 4100-130	3883015	1 set replacement blades HTBS-T 3100-100	3883030
		1 set replacement blades HTBS-T 3 100-130	3883031
		1 set replacement blades HTBS-T 3100-160	3883032
		1 set replacement blades HTBS-T 4100-60	3883034
		1 set replacement blades HTBS-T 4100-130	3883035
		Manual centralised lubrication system	3883036



Finger protection

- ▶ Fold-up finger protection on first metre



Rear stop

- ▶ Fold-up rear stop for over length cutting



Pneum. Support device

- ▶ for thin sheets (option)



Cutting kerf adjustment device

- ▶ There is a central adjusting lever on the machine frame that is used to adjust the cutting kerf by reference to a scale. This provides a fast and easy approach to changing settings and making the correct adjustments for the material and thickness and thus achieve the best possible cut quality.



Premium components

- ▶ Bosch, Rexroth, Hydac, Siemens, Telemecanique

Magnetic drilling
Deburring
Metal grinding
Cutting
Notching & punching
Bending
Presses
Circular saws
Roller conveyors
Metal-cutting band saws

Hydraulic slot-guided guillotine shears

HTBS-K – Hydraulic CNC sheet metal shears

Standard type

- ▶ Very heavy welded steel design
- ▶ CNC controller D-Touch 7
- ▶ Automatic, hydraulic cutting angle adjustment via D-Touch 7
- ▶ Automatic, motorised cutting kerf adjustment via D-Touch 7
- ▶ Motorised rear stop 1 000 mm
- ▶ Ergonomically arranged, pivoting control panel
- ▶ Rear stop driven via play-free ball screws, guided on linear rails
- ▶ Fold-up, split finger protection guard 1 000 mm

- ▶ Blank holder arranged close to cutting edge
- ▶ Operated via mobile foot switch with emergency stop switch
- ▶ One angle stop 1 500 mm and two sheet support arms 1 000 mm (three sheet support arms for machines as of 4 m)
- ▶ Rear stop area safeguarded by light barrier
- ▶ Lighting with cutting line display as silhouette

- ▶ Easy handling of sheet metal via ball transfer units in table
- ▶ Premium components by Bosch, Rexroth, Hydac, Siemens, Atos
- ▶ Premium rotatable knife, suitable for cutting stainless steel

DT7 (D-Touch 7)
more on page 76

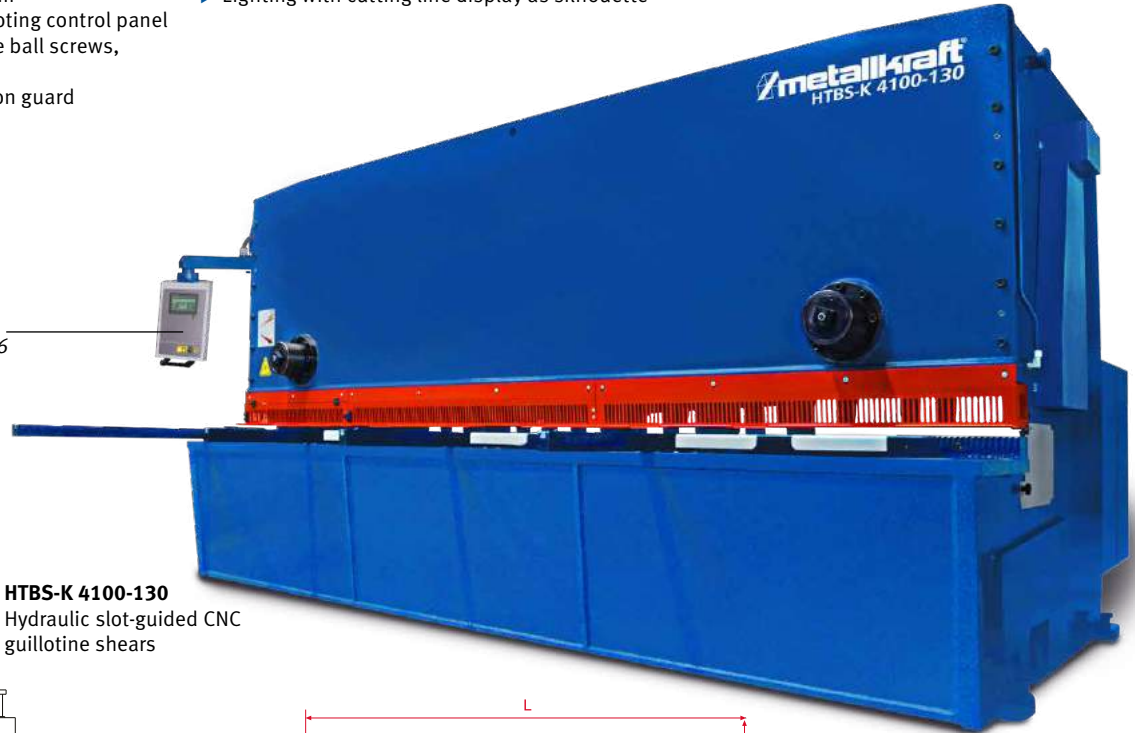

HTBS-K 4100-130
Hydraulic slot-guided CNC
guillotine shears

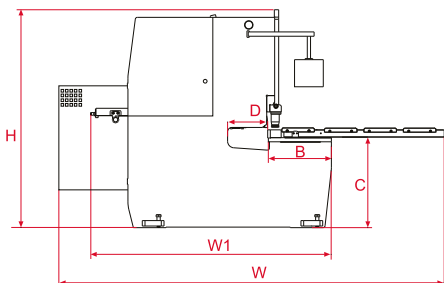

(L) Length
(W) Overall depth
(W1) Depth
(R) Table length

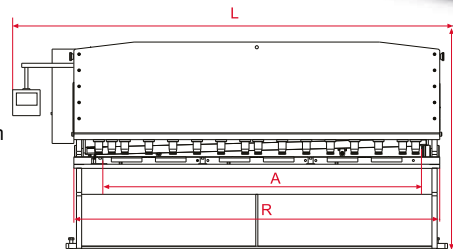

(A) Cut length
(B) Table depth
(C) Working height
(D) Throat
(H) Height

Model HTBS-K	3100-60	3100-100	3100-130	3100-160	3100-200	4100-60	4100-130	4100-160	4100-200
Art. no.	3826306	3826310	3826313	3826316	3826320	3826406	3826413	3826416	3826420

Technical data	3100-60	3100-100	3100-130	3100-160	3100-200	4100-60	4100-130	4100-160	4100-200
Cutting length (A)	3 080 mm	3 080 mm	3 080 mm	3 080 mm	3 080 mm	4 080 mm	4 080 mm	4 080 mm	4 080 mm
Cutting performance (450 N/mm ²)	6 mm	10 mm	13 mm	16 mm	20 mm	6 mm	13 mm	16 mm	20 mm
Cutting performance (700 N/mm ²)	4 mm	8 mm	10 mm	13 mm	16 mm	4 mm	10 mm	10 mm	16 mm
Stand throat (D)	350 mm	350 mm	350 mm	350 mm	350 mm	350 mm	350 mm	350 mm	350 mm
max. strokes per minute for full cutting length	20	20	17	12	12	20	13	9	8
min. max. cutting angle	0.3°-2°	0.3°-2°	0.3°-2°30'	0.3°-2°30'	0.3°-2°30'	0.3°-2°	0.3°-2°30'	2°30'	2°30'
Table height (C)	820 mm	820 mm	835 mm	840 mm	840 mm	820 mm	835 mm	1 000 mm	1 000 mm
Table depth (B)	494 mm	554 mm	559 mm	554 mm	580 mm	494 mm	589 mm	630 mm	630 mm
Table length (R)	3280 mm	3360 mm	3380 mm	3420 mm	3460 mm	4400 mm	4400 mm	4385 mm	4405 mm
Number of blank holders	16	16	17	14	14	20	20	17	21
Min. max. pressure of blank holders	4-20 t	4-20 t	8-40 t	11-55 t	17-83 t	4-20 t	10-48 t	50-100 t	50-100 t
Speed Rear stop	200 mm/sec	200 mm/sec	200 mm/sec	200 mm/sec	200 mm/sec	200 mm/sec	200 mm/sec	200 mm/sec	200 mm/sec
Driving power 400 V/50 Hz	11 kW	22 kW	30 kW	45 kW	45 kW	11 kW	30 kW	45 kW	45 kW
Oil tank capacity	125 l	180 l	300 l	400 l	500 l	125 l	300 l	400 l	500 l
Length (l)	4 100 mm	3800 mm	4200 mm	4130 mm	4 100 mm	5 150 mm	6200 mm	5890 mm	5900 mm
Depth (W1)	2 050 mm	2 050 mm	2 100 mm	2 210 mm	2 300 mm	2 100 mm	2 150 mm	2 100 mm	2 200 mm
Overall depth (W)	3 650 mm	3 550 mm	3 560 mm	3 820 mm	3 700 mm	3 550 mm	3 560 mm	3 625 mm	3 775 mm
Height (H)	1 950 mm	2 150 mm	2 450 mm	2 570 mm	2 650 mm	2 050 mm	2 550 mm	2 950 mm	2 950 mm
Weight	7 500 kg	9 300 kg	12 900 kg	18 000 kg	21 500 kg	12 000 kg	16 500 kg	23 600 kg	29 000 kg

All hydraulic sheet metal shears are supplied with oil.

More models on request.

Custom accessor

- ▶ Pneumatic thin sheet support device with one or two stages
- ▶ Laser cutting line display
- ▶ Light barrier instead of finger protection grille
- ▶ Removable mitre stop
- ▶ Extended lateral stop with sheet support arms
- ▶ Transfer balls for lateral stop and sheet support arms



Size example HTBS-K 10000-130



Magnetic drilling

Deburring

Metal grinding

Cutting

Notching & punching

Bending

Presses

Circular saws

Roller conveyors

Metal-cutting band saws

Hydraulic slot-guided sheet metal shears

Accessories for hydraulic CNC guillotine shears



(C)NC controller D-Touch 7:

- ▶ Glare-free rugged 7" colour touchscreen control panel
- ▶ Easy positioning to the desired dimension
- ▶ Unlimited program and single cut definitions
- ▶ Unlimited material definitions in the material library
- ▶ Intuitive menu-guided operation
- ▶ Separate displays for ACTUAL and TARGET values
- ▶ Rear stop move out function
- ▶ Cutting kerf compensation
- ▶ Positioning accuracy 0.1 mm
- ▶ Cut length validation via configurable stroke length
- ▶ Cut counter
- ▶ Control of machine accessories (e.g., optional sheet support device) and motorised cutting kerf adjustment



Finger protection

- ▶ Fold-up finger protection on first metre

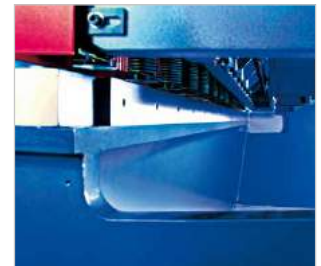

Throat

- ▶ Supports cutting of steel sheets longer than the cutting length (A)

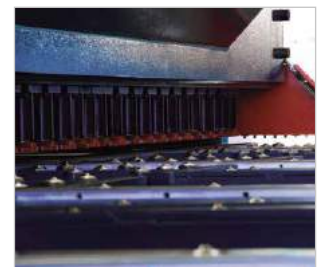

Finger protection device

- ▶ by means of safety light barrier (option)

Accessories	Art. no.	Accessories	Art. no.
Safety light barrier (instead of finger guard)	3883040	Sheet holding device with conveyor belt and waste container HTBS-K 3100-60/3100-100/3100-130	3883057
Throat 500 mm HTBS-K 3100-60 CNC	3883041	Sheet holding device with conveyor belt and waste container HTBS-K 3100-160	3883058
Throat 500 mm HTBS-K 3100-100/3100-130/4100-60 CNC	3883042	Sheet holding device with conveyor belt and waste container HTBS-K 4100-60/4100-130	3883059
Throat 500 mm HTBS-K 3100-160/4100-130/4100-160 CNC	3883043	Sheet holding device with conveyor belt and waste container HTBS-K 4100-160	3883060
Throat 500 mm HTBS-K 3100-200/4100-200 CNC	3883044	Stack conveyor HTBS-K 3100-60/3100-100/3100-130	3883061
Pneumatic thin sheet support device	3883045	Stack conveyor HTBS-K 3100-160	3883062
Standard HTBS-K- 3100-60/3 100-100/3100-130	3883046	Stack conveyor HTBS-K 4100-60/4100-130	3883063
Pneumatic thin sheet support device	3883047	Stack conveyor HTBS-K 4100-160	3883064
Standard HTBS-K 3100-160/3100-200	3883048	Rear stop 1 250 mm	3883065
Pneumatic thin sheet support device	3883049	Rear stop swivels up hydraulically HTBS-K 3100-160/3100-200/4100-130/4100-160/4100-200	3883066
Standard HTBS-K 4100-60/4100-130	3883050	Angle-adjustable side stop 0-180°	3883067
Pneumatic thin sheet support device	3883051	Support arm L=2 m (1 pc.)	3883068
two-level HTBS-K 3100-60	3883052	Support arm L=3 m (1 pc.)	3883069
Pneumatic thin sheet support device	3883053	Support arm extension L=2 m (1 pc.)	3883070
two-level HTBS-K 3100-100	3883054	Support arm extension L=3 m (1 pc.)	3883071
Pneumatic thin sheet support device	3883055	Side stop extension L=2 m (1 pc.)	3883072
two-level HTBS-K 4100-60	3883056	Side stop extension L=3 m (1 pc.)	3883073
Pneumatic thin sheet support device	3883057	Side stop (1500 mm) on right side	3883074
two-level HTBS-K 4100-130	3883058	Laser cutting line	3883075
Pneumatic thin sheet support device return to sender max. 6 mm	3883059	1 replacement knife set HTBS-K 3100-60	3883076
HTBS-K 3100-60/3100-100/3100-130	3883060	1 replacement knife set HTBS-K 3100-100	3883077
Pneumatic thin sheet support device return to sender max. 6 mm HTBS-K 3100-160	3883061	1 replacement knife set HTBS-K 3100-130	3883078
Pneumatic thin sheet support device return to sender max. 6 mm HTBS-K 3100-200	3883062	1 replacement knife set HTBS-K 3100-160	3883079
HTBS-K 4100-60/4100-130	3883063	1 replacement knife set HTBS-K 3100-200	3883080
Pneumatic thin sheet support device return to sender max. 6 mm HTBS-K 4100-60	3883064	1 replacement knife set HTBS-K 4100-60	3883081
Pneumatic thin sheet support device return to sender max. 6 mm HTBS-K 4100-130	3883065	1 replacement knife set HTBS-K 4100-130	3883082
HTBS-K 4100-160/4100-200	3883066	1 replacement knife set HTBS-K 4100-160	3883083
Pneumatic thin sheet support device return to sender max. 6 mm HTBS-K 4100-160	3883067	1 replacement knife set HTBS-K 4100-200	3883084
	3883068	Manual centralised lubrication system	3883085



Notching, punching and profile shears

Notching machines

MRA – Manual pipe notcher

- ▶ For notching pipes up to 4.5 mm wall thickness
- ▶ Up to three pipe diameters can be notched (MRA 2)
- ▶ Can be used both horizontally and vertically
- ▶ Low force application

Scope of delivery:

› 1 knife set

Model	MRA 2	MRA 3
Art. no.	3772992	3772993
Technical specifications		
Pipe diameter*	28 / 34 / 43 mm	50 / 61 mm
Wall thickness (aluminium)	4.5 mm	4.5 mm
Wall thickness (copper)	4 mm	4 mm
Wall thickness (brass)	4 mm	4 mm
Wall thickness (construction steel*)	3 mm	3 mm
Wall thickness (stainless steel)	2 mm	2 mm
Notcher dimensions with lever	1060 x 160 x 80 mm	1090 x 160 x 105 mm
Weight	8 kg	15 kg

*Performance data for material with tensile strength of 400 N/mm²

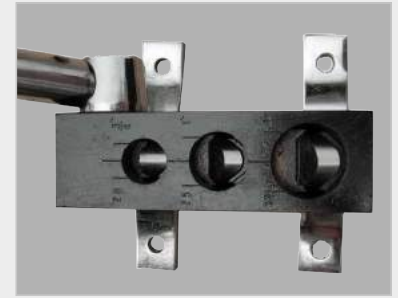

▶ Up to three pipe diameters can be notched (MRA2)

Option	Art. no.
Replacement knife set MRA 2	3772996
Replacement knife set MRA 3	3772997

AKM 100 T – Manual notching machine

- ▶ Fast and easy straight notching with burr-free cut and without deformation of the cut edges
- ▶ Rugged grey cast iron design
- ▶ Adjustable stops with scale for convenient working

Scope of delivery:

› Blade

Model	AKM 100T
Art. no.	3770512
Technical specifications	
Cutting performance*	3 mm
Cutting area	100 x 100 mm
Cutting angle	90°
Work table	380 x 280 mm
Weight	90 kg
Stroke adjustment	30 mm
Dimensions L x W x H	450 x 390 x 1 020 mm

*Performance data for material with tensile strength of 400 N/mm²



AKM 100T
Manual notching machine



Rugged steel design

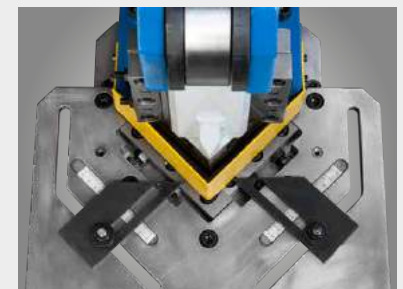

Easy scale setting

Accessories	Art. no.
Replacement knife AKM 100 T	3880701

AKM P – Pneumatic notching machine

- ▶ Stable design
- ▶ For fast straight notching in steel sheet
- ▶ User-friendly and labour-saving thanks to pneumatic drive
- ▶ Solid table with recessed scales and T slots for precise adjustment of the swivelling stops
- ▶ Finger protection cover made of Plexiglas enables an optimal view of the cutting edge
- ▶ Operation via foot pedal

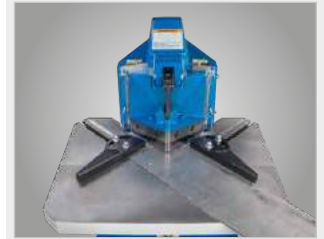

▶ Table with stops and scale

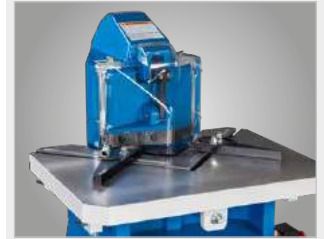

▶ Plexiglas finger protection



▶ Stops with mitre adjustment



▶ Maintenance unit for pneumatics

Scope of delivery:

- > Bottom knife set for steel
- > Top knife set for steel

Model	AKM 130-3 P	AKM 150-2 P
Art. no.	3833130	3832150

Technical specifications	AKM 130-3 P	AKM 150-2 P
Cutting capacity (400 N/mm ²)	3 mm	2 mm
Cutting capacity (600N/mm ²)	1.5 mm	1.0 mm
Max. cutting pressure	2.2 t	2.2 t
Cutting area	130 x 130 mm	154 x 154 mm
Notching angle	90°	90°
Strokes/min	50	40
Table height	945 mm	945 mm
Table size	600 x 460 mm	600 x 460 mm
Dimensions (L x W x H) max.	1 020 x 660 x 1 260 mm	860 x 800 x 1 260 mm
Weight approx.	160 kg	170 kg

* only possible with optional knife set

Accessories AKM 130-3 P	Art. no.
Bottom knife set for steel	3839000
Top knife set for steel	3839001
Bottom knife set for stainless steel	3839002
Top knife set for stainless steel	3839003

Accessories AKM 150-2 P	Art. no.
Bottom knife set for steel	3839010
Top knife set for steel	3839011
Bottom knife set for stainless steel	3839012
Top knife set for stainless steel	3839013

Notching machines

AKM H – Hydraulic notching machine for fast straight notching in steel sheet

- ▶ Heavy-duty, rugged design
- ▶ User-friendly and labour-saving thanks to hydraulic drive
- ▶ Solid table with recessed scales and T slots for precise adjustment of the swivelling stops
- ▶ Finger protection cover made of Plexiglas enables an optimal view of the cutting edge
- ▶ Displaceable hold-down device
- ▶ Waste pieces are discharged through a scrap chute
- ▶ Operation via foot pedal



AKM 220-4 H



AKM 220-6 H



▶ Stops with adjustable blank holders

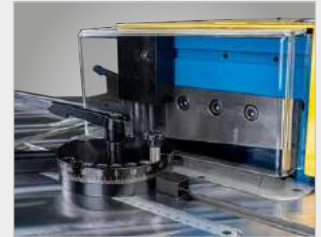

▶ Recessed scales and T slots for precise adjustment of the swivelling stops

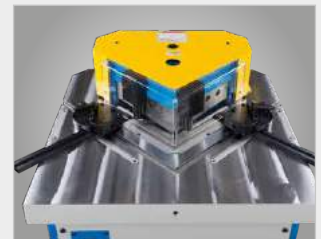

▶ Finger protection cover made of Plexiglas enables an optimal view of the cutting edge

Scope of delivery:

- > Bottom knife set for steel
- > Top knife set for steel

Model	AKM 220-4 H	AKM 220-6 H
Art. no.	3834200	3836200
Technical specifications		
Cutting capacity (400 N/mm ²)	4 mm	6 mm
Cutting capacity (600N/mm ²)	2 mm	3 mm
Max. cutting pressure	22 t	24 t
Cutting area	200 x 200 mm	220 x 220 mm
Notching angle	90 °	90 °
Strokes/min	50	15
Table size	700 x 600 mm	650 x 650 mm
Motor output	2.25 kW	3.0 kW
Dimensions (L x W x H) max.	1 030 x 900 x 1 050 mm	860 x 860 x 1 100 mm
Weight	375 kg	495 kg

* Values for stainless steel (tensile strength 600 N/mm²) only possible with optional knife set

Accessories AKM 220-4 H	Art. no.
Bottom knife set for steel	3839020
Top knife set for steel	3839021
Bottom knife set for stainless steel	3839022
Top knife set for stainless steel	3839023

Accessories AKM 220-6 H	Art. no.
Bottom knife set for steel	3839030
Top knife set for steel	3839031
Bottom knife set for stainless steel	3839032
Top knife set for stainless steel	3839033

AKM V – Hydraulic notching machines with adjustable angle of 30 - 140°

- ▶ Heavy and stable welded design
- ▶ Precision steel table with recessed scale and T grooves for precise adjustment of the stops
- ▶ Stops adjustable ± 45°
- ▶ Fast angle adjustment of blades via hand wheels
- ▶ Drawer for cut-off waste
- ▶ Easy operation via foot pedal
- ▶ Premium rotatable knife, suitable for cutting stainless steel
- ▶ Time-saving stroke adjustment for adapting the cutting length
- ▶ Two hydraulic blank holders



AKM 200-60 V

Scope of delivery:

- > 1 knife set
- > Hydraulic oil

AKM V- notching machine with variable angle adjustment

Technical specifications	Cutting performance 30°	Cutting performance 60°	Cutting area in mm	Cutting angle	Oil reservoir content	Motor output	Electrical connection	Weight	Dimensions L x W x H	Article no.
AKM 200-60 V	6 mm	4 mm	200 x 200	30 - 140°	50 l	4.0 kW	400 V/50 Hz	1 000 kg	1 050 x 900 x 1 300	3817005

* Values for stainless steel (tensile strength 600 N/mm²) only possible with optional knife set



Work table with T grooves and recessed scales
Hydraulic blank holder

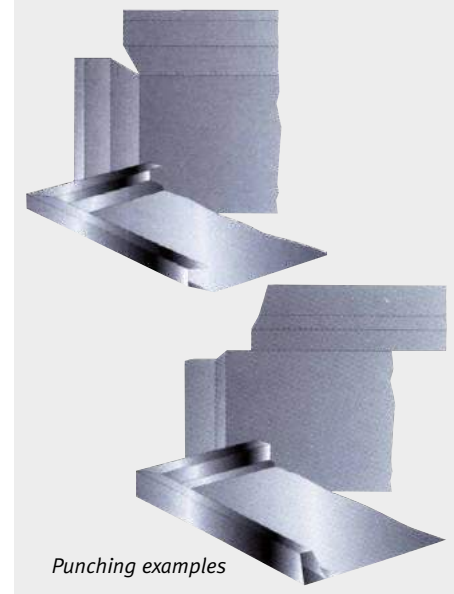

Punching examples

Accessories	Art. no.
Replacement knives (1 set)	3880019

Hydraulic section steel shears/hole punches

HPS – combined hydr. steel section shears/hole punches with up to 5 processing stations and foot operation

- ▶ Punching station, flat steel shears, angled steel shears, steel section shears, as of HPS 45S with notching station
- ▶ DS series with two work cylinders and two foot pedals for working with the punching station and steel section shears at the same time
- ▶ Continuously variable stroke length setting
- ▶ Larger throat for punching station with 620 mm optionally available as of HPS 55DS
- ▶ Heavy and stable welded design
- ▶ With notching knife as standard as of HPS 45S
- ▶ With powerful 400 Volt motor
- ▶ Optional V notching knife, extra-large punching unit and longer throat for punching station available on request
- ▶ Two-stage foot pedal for inching operation
- ▶ With MUBEA mount as standard for no. 1, no. 2 and no. 3 punches and no. 30, no. 45 and no. 60 dies, use of no. 4 and no. 80 punch and die possible as an optional



HPS 40S



Scope of supply HPS 40S:

- > Punching station
- > Flat steel shears
- > Angled steel shears
- > Steel section shears with round and square knife
- > Punch mount with bayonet closure
- > MUBEA punch mount no. 1, no. 2, no. 3
- > MUBEA die reducers no. 30 and no. 45 (no. 60 is fitted directly in the punching seat)
- > Punch and flat steel shears with adjustable stops
- > Hook wrench
- > Foot pedal
- > Hydraulic oil

Technical specifications	HPS 40S	HPS 45S	HPS 60S	HPS 55DS	HPS 65DS	HPS 85DS	HPS 115DS	HPS 175DS
Art. no.	3819040	3819045	3819060	3819055	3819065	3819085	3819115	3819175
Punching station								
Punching force	40 t	45 t	60 t	55 t	65 t	85 t	115 t	175 t
Ø x max. sheet thickness **	Ø 20 x 15 mm	Ø 22 x 15 mm	Ø 28 x 15 mm	Ø 20 x 20 mm	Ø 26 x 20 mm	Ø 33 x 20 mm	Ø 34 x 26 mm	Ø 40 x 32 mm
Ø max. x sheet thickness **	Ø 30 x 10 mm	Ø 38 x 8 mm	Ø 38 x 11 mm	Ø 40 x 10 mm	Ø 57 x 10 mm***	Ø 57 x 10 mm***	Ø 55 x 16 mm***	Ø 57 x 22 mm***
Throat	175 mm	175 mm	220 mm	255 mm	305 mm	355 mm	355 mm	625 mm
Stroke	50 mm	50 mm	55 mm	60 mm	55 mm	80 mm	80 mm	80 mm
Stroke/min.	20	20	25	25	25	25	25	22
Hole punch working height	970 mm	935 mm	955 mm	1 030 mm	1 030 mm	1 080 mm	1 110 mm	1 130 mm
Steel bar shears								
Round/rectangular in mm	Ø 30 / 25	Ø 30 / 25	Ø 40 / 35	Ø 40 / 40	Ø 45 / 45	Ø 50 / 50	Ø 55 / 50	Ø 65 / 50
Angled steel shears								
90° cut in mm	80 x 80 x 8	100 x 100 x 10	120 x 120 x 12	120 x 120 x 12	120 x 120 x 12	150 x 150 x 15	150 x 150 x 15	200 x 200 x 15
45° cut in mm	50 x 50 x 6	70 x 70 x 6	80 x 80 x 8	70 x 70 x 10	70 x 70 x 10	80 x 80 x 8	80 x 80 x 10	80 x 80 x 10
Working height	1 100 mm	1 140 mm	1 155 mm	1 130 mm	1 140 mm	1 200 mm	1 215 mm	1 130 mm
Flat steel shears								
Max. material thickness	200 x 13 mm	200 x 15 mm	200 x 20 mm	200 x 20 mm	300 x 20 mm	380 x 20 mm	380 x 25 mm	380 x 30 mm
Max material size	300 x 6 mm	300 x 12 mm	300 x 15 mm	300 x 15 mm	375 x 15 mm	480 x 15 mm	600 x 15 mm	600 x 20 mm
Knife length	356 mm	316 mm	317 mm	317 mm	380 mm	482 mm	610 mm	610 mm
45° cut at max. angle profile in mm	80 x 80 x 10	80 x 80 x 10	80 x 80 x 10	80 x 80 x 15	100 x 100 x 15	120 x 120 x 15	120 x 120 x 15	120 x 120 x 15
Working height	980 mm	935 mm	955 mm	900 mm	900 mm	940 mm	935 mm	810 mm
Notching station								
Max. material thickness	-	8 mm	10 mm	10 mm	10 mm	13 mm	13 mm	16 mm
Width	-	35 mm	42 mm	45 mm	45 mm	52 mm	60 mm	60 mm
Depth	-	75 mm	100 mm	90 mm	90 mm	100 mm	100 mm	100 mm
Motor output	3 kW	4 kW	4 kW	5.5 kW	5.5 kW	7.5 kW	11 kW	11 kW
Electrical connection	400 V/50 Hz	400 V/50 Hz	400 V/50 Hz	400 V/50 Hz	400 V/50 Hz	400 V/50 Hz	400 V/50 Hz	400 V/50 Hz
Net weight	580 kg	1 165 kg	1 440 kg	1 520 kg	1 600 kg	2 315 kg	2 920 kg	6 000 kg
Dimensions in mm	1 100 x 800 x 1 520	1 430 x 950 x 1 780	1 520 x 950 x 1 780	1 500 x 950 x 1 880	1 700 x 950 x 1 880	1 920 x 950 x 2 040	2 040 x 950 x 2 180	2 730 x 1 150 x 2 280
Optional equipment								
Punching station throat	-	-	-	620 mm	620 mm	620 mm	620 mm	-
U-I profile cutter	76 x 38 mm	80 x 45 mm	80 x 45 mm	120 x 58 mm	120 x 58 mm	160 x 74 mm	200 x 90 mm	300 x 125 mm
T profile cutter	38 x 6 mm	40 x 5 mm	80 x 9 mm	80 x 9 mm	90 x 11 mm	100 x 11 mm	120 x 13 mm	150 x 15 mm
V notching tools in mm	100 x 100 x 8	100 x 100 x 10	100 x 100 x 10	100 x 100 x 10	100 x 100 x 10	100 x 100 x 13	100 x 100 x 13	100 x 100 x 16

All hydraulic steel section shears are delivered with oil. * Please turn over for descriptions of the transport surcharges.

Performance data for material with tensile strength of 400 N/mm² *Extra-large punching unit option required



▶ Punching station



▶ Angled steel shears



▶ Flat steel shears



▶ Steel bar shears /
Steel bar knives

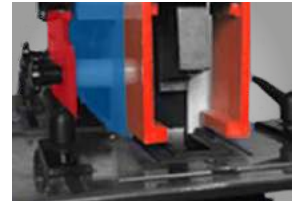

▶ Notching station
(as of HPS 45S)

Scope of supply HPS 45S/ HPS 60S

- › Punching station
- › Flat steel shears
- › Angled steel shears
- › Steel section shears with round and square knife
- › Notching station
- › Punch mount with bayonet closure
- › MUBEA punch mount no. 1, no. 2, no. 3
- › MUBEA die reducers no. 30 and no. 45 (no. 60 is fitted directly in the punching seat)
- › Punch, flat steel shears and notcher with adjustable stops
- › Hook wrench
- › Foot pedal
- › Hydraulic oil



HPS 45S



HPS 55DS

**Scope of supply HPS 55DS / HPS 65DS /
HPS 85DS / HPS 115DS / HPS 175DS:**

- › Punching station
- › Flat steel shears
- › Angled steel shears
- › Steel section shears with round and square knife
- › Notching station
- › Work lamp
- › Electrical contact stop
- › Punch mount with bayonet closure
- › MUBEA punch mount no. 1, no. 2, no. 3
- › MUBEA die reducers no. 30 and no. 45 (no. 60 is fitted directly in the punching seat)
- › Punch with adjustable stop and scale, flat steel shears and notcher with adjustable stops
- › Hook wrench
- › 2 working cylinders and 2 foot pedals
- › Hydraulic oil

Hydraulic section steel shears/hole punches



HPS 115DS



HPS 175DS



▶ Electrical contact stop
(standard as of HPS 55DS)



▶ Work light standard
as of HPS 55DS

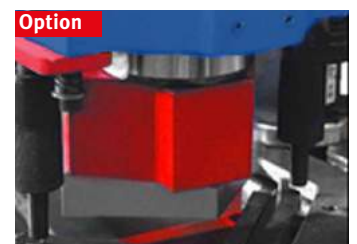

▶ Option
Optional V notching knife
available as of HPS 45S

Accessories for hydraulic section steel shears

Replacement knife set for flat steel station	Art. no.	Knife set for IPN sections	Art. no.	Edge bending unit	Art. no.
for HPS 40S / 45S	3887010	for HPS 40S / 45S	3887050	100 x 12 mm for HPS 45S	3887090
for HPS 60S	3887011	for HPS 60S	3887051	110 x 12 mm for HPS 60S	3887091
for HPS 55DS / 65DS	3887012	for HPS 55DS / 65DS	3887052	250 x 15 mm for HPS 55DS / 65DS	3887092
for HPS 85DS	3887013	for HPS 85DS	3887053	500 x 3 mm for HPS 55DS / 65DS	3887093
for HPS 115DS	3887014	for HPS 115DS	3887054	250 x 20 mm for HPS 85DS	3887094
for HPS 175DS	3887015	for HPS 175DS	3887055	500 x 3 mm for HPS 85DS	3887095
				250 x 22 mm for HPS 115DS	3887096
				500 x 3 mm for HPS 115DS	3887097
				250 x 25 mm for HPS 175DS	3887098
				700 x 4 mm for HPS 175DS	3887099
Replacement knife set for angled steel station	Art. no.	Knife set for UPN sections	Art. no.	Die block for U section	Art. no.
for HPS 40S / 45S	3887020	for HPS 40S / 45S	3887060	for HPS 40S / 45S	3887105
for HPS 60S	3887021	for HPS 60S	3887061	for HPS 60S	3887106
for HPS 55DS / 65DS	3887022	for HPS 55DS / 65DS	3887062	for HPS 55DS / 65DS	3887107
for HPS 85DS	3887023	for HPS 85DS	3887063	for HPS 85DS	3887108
for HPS 115DS	3887024	for HPS 115DS	3887064	for HPS 115DS	3887109
for HPS 175DS	3887025	for HPS 175DS	3887065	for HPS 175DS	3887110
Replacement knife set for steel bar station	Art. no.	Knife set for T sections	Art. no.	620 mm throat for punching station (only available ex works)	Art. no.
for HPS 40S / 45S	3887026	for HPS 40S / 45S	3887070	for HPS 55DS	3887120
for HPS 60S	3887027	for HPS 60S	3887071	for HPS 65DS	3887121
for HPS 55DS / 65DS	3887028	for HPS 55DS / 65DS	3887072	for HPS 85DS	3887122
for HPS 85DS	3887029	for HPS 85DS	3887073	for HPS 115DS	3887123
for HPS 115DS	3887030	for HPS 115DS	3887074		
for HPS 175DS	3887031	for HPS 175DS	3887075		
Replacement knife set for notching station	Art. no.	V knife set 100 x 100 mm for notching station incl. mounts and bed	Art. no.	Punch and die mounts (fit all standard HPS models)	Art. no.
for HPS 45S	3887040	for HPS 45S	3887130	Punch insert no. 1*	3889002
for HPS 60S	3887041	for HPS 60S	3887131	Punch reducer no. 1*	3889003
for HPS 55DS / 65DS	3887042	for HPS 55DS	3887132	Punch mount no. 2	3889005
for HPS 85DS	3887043	for HPS 65DS	3887133	Punch mount no. 3	3889006
for HPS 115DS	3887044	for HPS 85 DS	3887134	Die reducer 60-30	3889000
for HPS 175DS	3887045	for HPS 115DS	3887135	Die reducer 60-45	3889001
		for HPS 175DS	3887136		
Oversize punching unit (fits all standard HPS models)	Art. no.	Replacement V blade set 100 x 100 mm	Art. no.	* Punch insert no. 1, punch reducer no. 1 and punch mount no. 2 are required to use punch no. 1	
for HPS 45S	3887160	for HPS 45S	3887080		
for HPS 60S	3887161	for HPS 60S	3887081		
for HPS 55DS	3887162	for HPS 55DS / 65DS	3887082		
for HPS 65DS	3887163	for HPS 85DS	3887083		
for HPS 85 DS	3887164	for HPS 115DS	3887084		
for HPS 115DS	3887165	for HPS 175DS	3887085		
for HPS 175DS	3887166				
Electrical contact stop	Art. no.				
for HPS 45S	3887150				
for HPS 60S	3887151				

(required for using punch no. 4 and die no. 80)



Various steel section knives, die blocks and special punches and dies available on request.

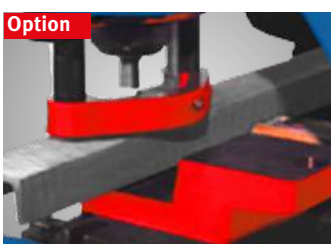

▶ Optional die block for U sections



▶ Optional die block for angled steel



▶ Optional edge bending unit for flat steel (available as of HPS 45S)

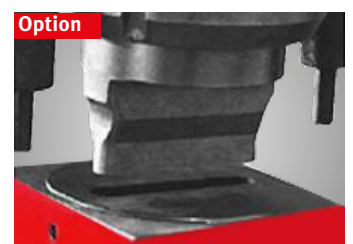

▶ Optional punching unit for large diameters

Hydraulic hole punches



► Various optional punching tools on request

HLS – Hydraulic foot-operated hole punches from 65 to 175 t punching force

- For punching sheet metal, flat and U steels
 - Heavy and stable welded design
 - Punching table with scale and stops
 - Particularly long throat of 625 mm
 - Time-saving, continuously adjustable stroke setting
 - With powerful motor
 - Continuously variable stroke length setting
 - Die block with second mount for processing UPN sections
- With MUBEA mount as standard for no. 1, no. 2 and no. 3 punches and no. 30, no. 45 and no. 60 dies, use of no. 4 and no. 80 punch and die possible as an optional

Please state the material type you would like to process in your order!

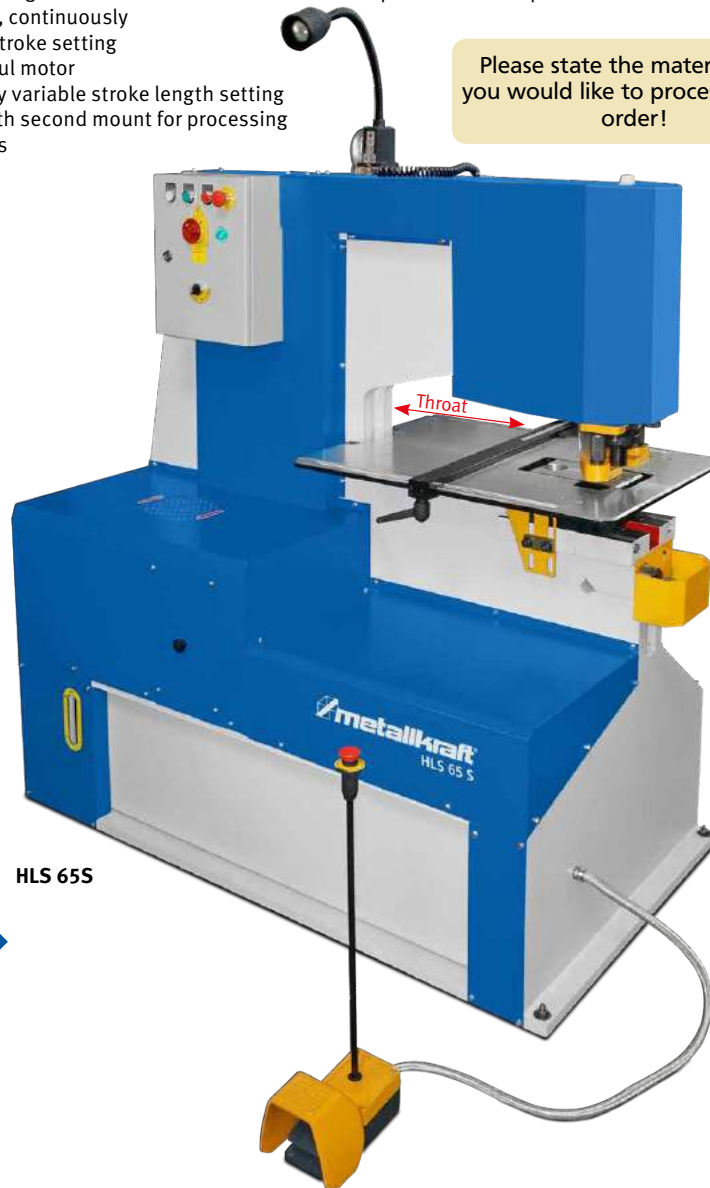

HLS 65S

Scope of delivery:

- Punch mount with bayonet closure
- MUBEA punch mount no. 1, no. 2, no. 3
- MUBEA die reducers no. 30 and no. 45 (no. 60 is fitted directly in the punching seat)
- Stop with scale
- Work lamp
- Foot pedal
- Hook wrench
- Hydraulic oil

Model	HLS 65S	HLS 85S	HLS 115S	HLS 175S
Art. no.	3818065	3818085	3818115	3818175
Technical specifications				
Punching force	65 t	85 t	115 t	175 t
Ø x max. sheet thickness **	Ø 26 x 20 mm	Ø 33 x 20 mm	Ø 34 x 26 mm	Ø 40 x 32 mm
Ø max. x sheet thickness **	Ø 57 x 10*** mm	Ø 57 x 12*** mm	Ø 55 x 16*** mm	Ø 57 x 22*** mm
Throat	625 mm	625 mm	625 mm	625 mm
Stroke	55 mm	80 mm	80 mm	80 mm
Stroke/min.	22	21	21	21
Hole punch working height	950 mm	950 mm	950 mm	950 mm
Motor output	5.5 kW	7.5 kW	11 kW	11 kW
Electrical connection	400 V/50 Hz	400 V/50 Hz	400 V/50 Hz	400 V/50 Hz
Dimensions in mm	1 600 x 900 x 1 800	1 850 x 950 x 1 920	2 000 x 950 x 1 970	2 700 x 1 120 x 2 160
Weight	2 440 kg	3 270 kg	3 760 kg	5 270 kg
Optional				
Sheet metal bending max.	500 x 3 mm	500 x 3 mm	700 x 3 mm	700 x 4 mm

* Please turn over for descriptions of the transport surcharges. **Performance data for material with tensile strength of 400 N/mm² ***Extra-large punching unit option required

MUBEA punch and die system

- ▶ The desired hole diameter matches the punch diameter
- ▶ The die diameter depends on the material thickness

Cutting play for round hole, rectangular hole and square hole

Material thickness	mm	0 – 3.9	4 – 8.9	9 – 13.9	14 – 18.9	19 - 24
Cutting play	mm	0.2	0.7	1.2	1.7	2.2

Example: Punch Ø 15 mm and material thickness 10 mm -> die Ø 16.2

Cutting play for slotted hole

Material thickness	mm	0 – 5.9	6 - 14
Cutting play	mm	0.3	1.0

Example: Punch Ø 10 x 25 mm and material thickness 10 mm -> die Ø 11 x 26 mm

Round punch no. 1

(Ød)	Art. no.	(Ød)	Art. no.	(Ød)	Art. no.
3.0 mm	388933.0	7.5 mm	388937.5	12.0 mm	3889312.0
3.5 mm	388933.5	8.0 mm	388938.0	12.5 mm	3889312.5
4.0 mm	388934.0	8.5 mm	388938.5	13.0 mm	3889313.0
4.5 mm	388934.5	9.0 mm	388939.0	13.5 mm	3889313.5
5.0 mm	388935.0	9.5 mm	388939.5	14.0 mm	3889314.0
5.5 mm	388935.5	10.0 mm	3889310.0	14.5 mm	3889314.5
6.0 mm	388936.0	10.5 mm	3889310.5	15.0 mm	3889315.0
6.5 mm	388936.5	11.0 mm	3889311.0		
7.0 mm	388937.0	11.5 mm	3889311.5		



Round punch no. 2

(Ød)	Art. no.	(Ød)	Art. no.	(Ød)	Art. no.
14.0 mm	3889314.0	20.0 mm	3889320.0	25.5 mm	3889325.5
15.0 mm	3889315.0	20.5 mm	3889320.5	26.0 mm	3889326.0
15.5 mm	3889315.5	21.0 mm	3889321.0	26.5 mm	3889326.5
16.0 mm	3889316.0	21.5 mm	3889321.5	27.0 mm	3889327.0
16.5 mm	3889316.5	22.0 mm	3889322.0	27.5 mm	3889327.5
17.0 mm	3889317.0	22.5 mm	3889322.5	28.0 mm	3889328.0
17.5 mm	3889317.5	23.0 mm	3889323.0	28.5 mm	3889328.5
18.0 mm	3889318.0	23.5 mm	3889323.5	29.0 mm	3889329.0
18.5 mm	3889318.5	24.0 mm	3889324.0	29.5 mm	3889329.5
19.0 mm	3889319.0	24.5 mm	3889324.5	30.0 mm	3889330.0
19.5 mm	3889319.5	25.0 mm	3889325.0		



Round punch no. 3

(Ød)	Art. no.	(Ød)	Art. no.	(Ød)	Art. no.
30.5 mm	3889330.5	34.0 mm	3889334.0	38.0 mm	3889338.0
31.0 mm	3889331.0	35.0 mm	3889335.0	39.0 mm	3889339.0
32.0 mm	3889332.0	36.0 mm	3889336.0	40.0 mm	3889340.0
33.0 mm	3889333.0	37.0 mm	3889337.0		



Round punch no. 4*

(Ød)	Art. no.	(Ød)	Art. no.	(Ød)	Art. no.
41.0 mm	3889330.5	45.0 mm	3889334.0	49.0 mm	3889338.0
42.0 mm	3889331.0	46.0 mm	3889335.0	50.0 mm	3889339.0
43.0 mm	3889332.0	47.0 mm	3889336.0		
44.0 mm	3889333.0	48.0 mm	3889337.0		



Round die no. 30

(Ød)	Art. no.	(Ød)	Art. no.	(Ød)	Art. no.
3.2 mm	388933.2	7.7 mm	388937.7	12.2 mm	3889312.2
3.7 mm	388933.7	8.2 mm	388938.2	12.7 mm	3889312.7
4.2 mm	388934.2	8.7 mm	388938.7	13.2 mm	3889313.2
4.7 mm	388934.7	9.2 mm	388939.2	13.7 mm	3889313.7
5.2 mm	388935.2	9.7 mm	388939.7	14.2 mm	3889314.2
5.7 mm	388935.7	10.2 mm	3889310.2	14.7 mm	3889314.7
6.2 mm	388936.2	10.7 mm	3889310.7	15.2 mm	3889315.2
6.7 mm	388936.7	11.2 mm	3889311.2	15.7 mm	3889315.7
7.2 mm	388937.2	11.7 mm	3889311.7		



Round die no. 45

(Ød)	Art. no.	(Ød)	Art. no.	(Ød)	Art. no.
14.7 mm	3889314.7	21.2 mm	3889321.2	27.7 mm	3889327.7
15.2 mm	3889315.2	21.7 mm	3889321.7	28.2 mm	3889328.2
15.7 mm	3889315.7	22.2 mm	3889322.2	28.7 mm	3889328.7
16.2 mm	3889316.2	22.7 mm	3889322.7	29.2 mm	3889329.2
16.7 mm	3889316.7	23.2 mm	3889323.2	29.7 mm	3889329.7
17.2 mm	3889317.2	23.7 mm	3889323.7	30.2 mm	3889330.2
17.7 mm	3889317.7	24.2 mm	3889324.2	30.7 mm	3889330.7
18.2 mm	3889318.2	24.7 mm	3889324.7	31.2 mm	3889331.2
18.7 mm	3889318.7	25.2 mm	3889325.2	31.7 mm	3889331.7
19.2 mm	3889319.2	25.7 mm	3889325.7	32.2 mm	3889332.2
19.7 mm	3889319.7	26.2 mm	3889326.2	32.7 mm	3889332.7
20.2 mm	3889320.2	26.7 mm	3889326.7		
20.7 mm	3889320.7	27.2 mm	3889327.2		



The punches and dies are not suitable for machining stainless steel. Tools for stainless steel can be quoted for on request.

* Use not possible with standard HPS/HLS scope of delivery – custom accessory "Oversized punching unit" required

Hydraulic hole punches

Round die no. 60

(Ød)	Art. no.	(Ød)	Art. no.	(Ød)	Art. no.
32.2 mm	3889332.2	35.7 mm	3889335.7	39.2 mm	3889339.2
32.7 mm	3889332.7	36.2 mm	3889336.2	39.7 mm	3889339.7
33.2 mm	3889333.2	36.7 mm	3889336.7	40.2 mm	3889340.2
33.7 mm	3889333.7	37.2 mm	3889337.2	40.7 mm	3889340.7
34.2 mm	3889334.2	37.7 mm	3889337.7	41.2 mm	3889341.2
34.7 mm	3889334.7	38.2 mm	3889338.2	41.7 mm	3889341.7
35.2 mm	3889335.2	38.7 mm	3889338.7	42.2 mm	3889342.2



Round die no. 80*

(Ød)	Art. no.	(Ød)	Art. no.	(Ød)	Art. no.
42.7 mm	3889342.7	45.7 mm	3889345.7	48.7 mm	3889348.7
43.2 mm	3889343.2	46.2 mm	3889346.2	49.2 mm	3889349.2
43.7 mm	3889343.7	46.7 mm	3889346.7	49.7 mm	3889349.7
44.2 mm	3889344.2	47.2 mm	3889347.2	50.2 mm	3889350.2
44.7 mm	3889344.7	47.7 mm	3889347.7	50.7 mm	3889350.7
45.2 mm	3889345.2	48.2 mm	3889348.2	51.2 mm	3889351.2

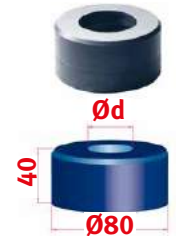

Slotted hole punch no. 2

(w x l)	Art. no.	(w x l)	Art. no.	(w x l)	Art. no.
5.0 x 10.0 mm	388945.0X10.0	8.0 x 30.0 mm	388948.0X30.0	13.0 x 20.0 mm	3889413.0X20.0
5.0 x 15.0 mm	388945.0X15.0	9.0 x 13.0 mm	388949.0X13.0	13.0 x 25.0 mm	3889413.0X25.0
5.0 x 20.0 mm	388945.0X20.0	9.0 x 18.0 mm	388949.0X18.0	13.0 x 30.0 mm	3889413.0X30.0
5.0 x 25.0 mm	388945.0X25.0	9.0 x 20.0 mm	388949.0X20.0	13.5 x 20.0 mm	3889413.5X20.0
5.5 x 11.0 mm	388945.5X11.0	9.0 x 25.0 mm	388949.0X25.0	13.5 x 25.0 mm	3889413.5X25.0
5.5 x 15.0 mm	388945.5X15.0	9.0 x 30.0 mm	388949.0X30.0	13.5 x 30.0 mm	3889413.5X30.0
5.5 x 20.0 mm	388945.5X20.0	9.5 x 20.0 mm	388949.5X20.0	14.0 x 20.0 mm	3889414.0X20.0
5.5 x 25.0 mm	388945.5X25.0	9.5 x 25.0 mm	388949.5X25.0	14.0 x 25.0 mm	3889414.0X25.0
6.5 x 13.0 mm	388946.5X13.0	9.5 x 30.0 mm	388949.5X30.0	14.0 x 30.0 mm	3889414.0X30.0
6.5 x 20.0 mm	388946.5X20.0	10.5 x 15.0 mm	3889410.5X15.0	16.0 x 25.0 mm	3889416.0X25.0
6.5 x 25.0 mm	388946.5X25.0	10.5 x 21.0 mm	3889410.5X21.0	16.0 x 30.0 mm	3889416.0X30.0
6.5 x 30.0 mm	388946.5X30.0	10.5 x 25.0 mm	3889410.5X25.0	17.5 x 25.0 mm	3889417.5X25.0
7.0 x 15.0 mm	388947.0X15.0	10.5 x 30.0 mm	3889410.5X30.0	17.5 x 30.0 mm	3889417.5X30.0
7.0 x 20.0 mm	388947.0X20.0	11.0 x 20.0 mm	3889411.0X20.0	19.0 x 25.0 mm	3889419.0X25.0
7.0 x 25.0 mm	388947.0X25.0	11.0 x 25.0 mm	3889411.0X25.0	19.0 x 30.0 mm	3889419.0X30.0
7.0 x 30.0 mm	388947.0X30.0	11.0 x 30.0 mm	3889411.0X30.0	20.5 x 30.0 mm	3889420.5X30.0
8.0 x 13.0 mm	388948.0X13.0	12.0 x 20.0 mm	3889412.0X20.0	22.5 x 30.0 mm	3889422.5X30.0
8.0 x 20.0 mm	388948.0X20.0	12.0 x 25.0 mm	3889412.0X25.0	25.5 x 30.0 mm	3889425.5X30.0
8.0 x 25.0 mm	388948.0X25.0	12.0 x 30.0 mm	3889412.0X30.0		



Slotted hole punch no. 3

(w x l)	Art. no.	(w x l)	Art. no.	(w x l)	Art. no.
9.0 x 40.0 mm	388949.0X40.0	16.0 x 35.0 mm	3889416.0X35.0	20.5 x 40.0 mm	3889420.5X40.0
11.0 x 35.0 mm	3889411.0X35.0	16.0 x 40.0 mm	3889416.0X40.0	22.5 x 35.0 mm	3889422.5X35.0
11.0 x 40.0 mm	3889411.0X40.0	17.5 x 35.0 mm	3889417.5X35.0	22.5 x 40.0 mm	3889422.5X40.0
13.5 x 35.0 mm	3889413.5X35.0	17.5 x 40.0 mm	3889417.5X40.0	24.0 x 40.0 mm	3889424.0X40.0
13.5 x 40.0 mm	3889413.5X40.0	19.0 x 35.0 mm	3889419.0X35.0	25.5 x 40.0 mm	3889425.5X40.0
14.0 x 35.0 mm	3889414.0X35.0	19.0 x 40.0 mm	3889419.0X40.0	26.0 x 40.0 mm	3889426.0X40.0
14.0 x 40.0 mm	3889414.0X40.0	20.5 x 35.0 mm	3889420.5X35.0	27.0 x 40.0 mm	3889427.0X40.0



Slotted hole punch no. 4*

(w x l)	Art. no.	(w x l)	Art. no.	(w x l)	Art. no.
11.0 x 45.0 mm	3889411.0X45.0	20.5 x 50.0 mm	3889420.5X50.0	26.0 x 50.0 mm	3889426.0X50.0
11.0 x 50.0 mm	3889411.0X50.0	22.5 x 50.0 mm	3889422.5X50.0	27.0 x 50.0 mm	3889427.0X50.0
13.5 x 50.0 mm	3889413.5X50.0	24.0 x 50.0 mm	3889424.0X50.0		
17.5 x 50.0 mm	3889417.5X50.0	25.5 x 50.0 mm	3889425.5X50.0		



Punch and die mounts (fit all standard HPS models)	Art. no.	Oversize punching unit (fits all standard HPS models)	Art. no.
Punch insert no. 1*	3889002	for HPS 45S	3887160
Punch reducer no. 1*	3889003	for HPS 60S	3887161
Punch mount no. 2	3889005	for HPS 55DS	3887162
Punch mount no. 3	3889006	for HPS 65DS	3887163
Die reducer 60-30	3889000	for HPS 85 DS	3887164
Die reducer 60-45	3889001	for HPS 115DS	3887165
		for HPS 175DS	3887166

(required for using punch no. 4 and die no. 80)

The punches and dies are not suitable for machining stainless steel. Tools for stainless steel can be quoted for on request.

* Use not possible with standard HPS/HLS scope of delivery – custom accessory "Oversized punching unit" required

Slotted hole punch no. 30

(w x l)	Art. no.	(w x l)	Art. no.	(w x l)	Art. no.
5.3 x 10.3 mm	388945.3X10.3	6.5 x 12.0 mm	388946.5X12.0	8.3 x 13.3 mm	388948.3X13.3
5.3 x 15.3 mm	388945.3X15.3	6.5 x 16.0 mm	388946.5X16.0	9.0 x 14.0 mm	388949.0X14.0
5.8 x 11.3 mm	388945.8X11.3	6.8 x 13.3 mm	388946.8X13.3	9.3 x 13.3 mm	388949.3X13.3
5.8 x 15.3 mm	388945.8X15.3	7.3 x 15.3 mm	388947.3X15.3	10.0 x 14.0 mm	3889410.0X14.0
6.0 x 11.0 mm	388946.0X11.0	7.5 x 14.0 mm	388947.5X14.0	10.8 x 15.3 mm	3889410.8X15.3
6.0 x 16.0 mm	388946.0X16.0	8.0 x 16.0 mm	388948.0X16.0	11.5 x 16.0 mm	3889411.5X16.0



Slotted hole punch no. 45

(w x l)	Art. no.	(w x l)	Art. no.	(w x l)	Art. no.
5.3 x 20.3 mm	3889485.3X20.3	9.8 x 30.3 mm	3889489.8X30.3	14.0 x 21.0 mm	38894814.0X21.0
5.3 x 25.3 mm	3889485.3X25.3	10.0 x 19.0 mm	38894810.0X19.0	14.0 x 26.0 mm	38894814.0X26.0
5.8 x 20.3 mm	3889485.8X20.3	10.0 x 21.0 mm	38894810.0X21.0	14.0 x 31.0 mm	38894814.0X31.0
5.8 x 25.3 mm	3889485.8X25.3	10.0 x 26.0 mm	38894810.0X26.0	14.3 x 20.3 mm	38894814.3X20.3
6.0 x 21.0 mm	3889486.0X21.0	10.0 x 31.0 mm	38894810.0X31.0	14.3 x 25.3 mm	38894814.3X25.3
6.0 x 26.0 mm	3889486.0X26.0	10.5 x 21.0 mm	38894810.5X21.0	14.3 x 30.3 mm	38894814.3X30.3
6.5 x 21.0 mm	3889486.5X21.0	10.5 x 26.0 mm	38894810.5X26.0	14.5 x 21.0 mm	38894814.5X21.0
6.5 x 26.0 mm	3889486.5X26.0	10.5 x 31.0 mm	38894810.5X31.0	14.5 x 26.0 mm	38894814.5X26.0
6.8 x 20.3 mm	3889486.8X20.3	10.8 x 21.3 mm	38894810.8X21.3	14.5 x 31.0 mm	38894814.5X31.0
6.8 x 25.3 mm	3889486.8X25.3	10.8 x 25.3 mm	38894810.8X25.3	15.0 x 21.0 mm	38894815.0X21.0
6.8 x 30.3 mm	3889486.8X30.3	10.8 x 30.3 mm	38894810.8X30.3	15.0 x 26.0 mm	38894815.0X26.0
7.3 x 20.3 mm	3889487.3X20.3	11.3 x 20.3 mm	38894811.3X20.3	15.0 x 31.0 mm	38894815.0X31.0
7.3 x 25.3 mm	3889487.3X25.3	11.3 x 25.3 mm	38894811.3X25.3	16.3 x 25.3 mm	38894815.3X25.3
7.3 x 30.3 mm	3889487.3X30.3	11.3 x 30.3 mm	38894811.3X30.3	16.3 x 30.3 mm	38894816.3X30.3
7.5 x 21.0 mm	3889487.5X21.0	11.5 x 22.0 mm	38894811.5X22.0	17.0 x 26.0 mm	38894817.0X26.0
7.5 x 26.0 mm	3889487.5X26.0	11.5 x 26.0 mm	38894811.5X26.0	17.0 x 31.0 mm	38894817.0X31.0
7.5 x 31.0 mm	3889487.5X31.0	11.5 x 31.0 mm	38894811.5X31.0	17.8 x 25.3 mm	38894817.8X25.3
8.0 x 21.0 mm	3889488.0X21.0	12.0 x 21.0 mm	38894812.0X21.0	17.8 x 30.3 mm	38894817.8X30.3
8.0 x 26.0 mm	3889488.0X26.0	12.0 x 26.0 mm	38894812.0X26.0	18.5 x 26.0 mm	38894818.5X26.0
8.0 x 31.0 mm	3889488.0X31.0	12.0 x 31.0 mm	38894812.0X31.0	18.5 x 31.0 mm	38894818.5X31.0
8.3 x 20.3 mm	3889488.3X20.3	12.3 x 20.3 mm	38894812.3X20.3	19.3 x 25.3 mm	38894819.3X25.3
8.3 x 25.3 mm	3889488.3X25.3	12.3 x 25.3 mm	38894812.3X25.3	19.3 x 30.3 mm	38894819.3X30.3
8.3 x 30.3 mm	3889488.3X30.3	12.3 x 30.3 mm	38894812.3X30.3	20.0 x 26.0 mm	38894820.0X26.0
9.0 x 21.0 mm	3889489.0X21.0	13.0 x 21.0 mm	38894813.0X21.0	20.0 x 31.0 mm	38894820.0X31.0
9.0 x 26.0 mm	3889489.0X26.0	13.0 x 26.0 mm	38894813.0X26.0	20.8 x 30.3 mm	38894820.8X30.3
9.0 x 31.0 mm	3889489.0X31.0	13.0 x 31.0 mm	38894813.0X31.0	21.5 x 31.0 mm	38894821.5X31.0
9.3 x 18.3 mm	3889489.3X18.3	13.3 x 20.3 mm	38894813.3X20.3	22.8 x 30.3 mm	38894822.8X30.3
9.3 x 20.3 mm	3889489.3X20.3	13.3 x 25.3 mm	38894813.3X25.3	23.5 x 31.0 mm	38894823.5X31.0
9.3 x 25.3 mm	3889489.3X25.3	13.3 x 30.3 mm	38894813.3X30.3	25.8 x 30.3 mm	38894825.8X30.3
9.3 x 30.3 mm	3889489.3X30.3	13.8 x 20.3 mm	38894813.8X20.3	26.5 x 31.0 mm	38894826.5X31.0
9.8 x 20.3 mm	3889489.8X20.3	13.8 x 25.3 mm	38894813.8X25.3		
9.8 x 25.3 mm	3889489.8X25.3	13.8 x 30.3 mm	38894813.8X30.3		



Slotted hole die no. 60

(w x l)	Art. no.	(w x l)	Art. no.	(w x l)	Art. no.
9.3 x 40.3 mm	388949.3X40.3	16.3 x 40.3 mm	3889416.3X40.3	21.5 x 36.0 mm	3889421.5X36.0
10.0 x 41.0 mm	3889410.0X41.0	17.0 x 36.0 mm	3889417.0X36.0	21.5 x 41.0 mm	3889421.5X41.0
11.3 x 40.3 mm	3889411.3X40.3	17.0 x 41.0 mm	3889417.0X41.0	22.8 x 35.3 mm	3889422.8X35.3
12.0 x 41.0 mm	3889412.0X41.0	17.8 x 35.3 mm	3889417.8X35.3	22.8 x 40.3 mm	3889422.8X40.3
13.8 x 35.3 mm	3889413.8X35.3	17.8 x 40.3 mm	3889417.8X40.3	23.5 x 36.0 mm	3889423.5X36.0
13.8 x 40.3 mm	3889413.8X40.3	18.5 x 36.0 mm	3889418.5X36.0	23.5 x 41.0 mm	3889423.5X41.0
14.3 x 35.3 mm	3889414.3X35.3	18.5 x 41.0 mm	3889418.5X41.0	24.3 x 40.3 mm	3889424.3X40.3
14.3 x 40.3 mm	3889414.3X40.3	19.3 x 35.3 mm	3889419.3X35.3	25.0 x 41.0 mm	3889425.0X41.0
14.5 x 36.0 mm	3889414.5X36.0	19.3 x 40.3 mm	3889419.3X40.3	26.3 x 40.3 mm	3889426.3X40.3
14.5 x 41.0 mm	3889414.5X41.0	20.0 x 36.0 mm	3889420.0X36.0	26.5 x 41.0 mm	3889426.5X41.0
15.0 x 36.0 mm	3889415.0X36.0	20.0 x 41.0 mm	3889420.0X41.0	27.0 x 41.0 mm	3889427.0X41.0
15.0 x 41.0 mm	3889415.0X41.0	20.8 x 35.3 mm	3889420.8X35.3	27.3 x 40.3 mm	3889427.3 x 40.3
16.3 x 35.3 mm	3889416.3X35.3	20.8 x 40.3 mm	3889420.8X40.3	28.0 x 41.0 mm	3889428.0 x 41.0



Slotted hole die no. 80*

(w x l)	Art. no.	(w x l)	Art. no.	(w x l)	Art. no.
11.3 x 45.3 mm	3889411.3X45.3	18.5 x 51.0 mm	3889418.5X51.0	25.8 x 50.3 mm	3889425.8X50.3
11.3 x 50.3 mm	3889411.3X50.3	20.8 x 50.3 mm	3889420.8X50.3	26.3 x 50.3 mm	3889426.3X50.3
12.0 x 46.0 mm	3889412.0X46.0	21.5 x 51.0 mm	3889421.5X51.0	26.5 x 51.0 mm	3889426.5X51.0
12.0 x 51.0 mm	3889412.0X51.0	22.8 x 50.3 mm	3889422.8X50.3	27.0 x 51.0 mm	3889427.0X51.0
13.8 x 50.3 mm	3889413.8X50.3	23.5 x 51.0 mm	3889423.5X51.0	27.3 x 50.3 mm	3889427.3X50.3
14.5 x 51.0 mm	3889414.5X51.0	24.3 x 50.3 mm	3889424.3X50.3	28.0 x 51.0 mm	3889428.0X51.0
17.8 x 50.3 mm	3889417.8X50.3	25.0 x 51.0 mm	3889425.0X51.0		



The punches and dies are not suitable for machining stainless steel. Tools for stainless steel can be quoted for on request.
* Use not possible with standard HPS/HLS scope of delivery – custom accessory "Oversized punching unit" required

Magnetic drilling
Deburring
Metal grinding
Cutting
Notching & punching
Bending
Presses
Circular saws
Roller conveyors
Metal-cutting band saws

Hydraulic hole punches

Square punch no. 2

(s)	Art. no.
4.0 mm	388954.0
5.0 mm	388955.0
6.0 mm	388956.0
7.0 mm	388957.0
8.0 mm	388958.0
9.0 mm	388959.0

(s)	Art. no.
10.0 mm	3889510.0
11.0 mm	3889511.0
12.0 mm	3889512.0
13.0 mm	3889513.0
14.0 mm	3889514.0
15.0 mm	3889515.0

(s)	Art. no.
16.0 mm	3889516.0
17.0 mm	3889517.0
18.0 mm	3889518.0
19.0 mm	3889519.0
20.0 mm	3889520.0



Square punch no. 3

(s)	Art. no.
21.0 mm	3889521.0
22.0 mm	3889522.0
23.0 mm	3889523.0
23.5 mm	3889523.5
24.0 mm	3889524.0

(s)	Art. no.
24.5 mm	3889524.5
25.0 mm	3889525.0
25.5 mm	3889525.5
26.0 mm	3889526.0
26.5 mm	3889526.5

(s)	Art. no.
27.0 mm	3889527.0
27.5 mm	3889527.5
28.0 mm	3889528.0



Square punch no. 4*

(s)	Art. no.
28.5 mm	3889528.5
29.0 mm	3889529.0
29.5 mm	3889529.5
30.0 mm	3889530.0
30.5 mm	3889530.5

(s)	Art. no.
31.0 mm	3889531.0
31.5 mm	3889531.5
32.0 mm	3889532.0
32.5 mm	3889532.5
33.0 mm	3889533.0

(s)	Art. no.
33.5 mm	3889533.5
34.0 mm	3889534.0
34.5 mm	3889534.5
35.0 mm	3889535.0



Square die no. 30

(s)	Art. no.
4.2 mm	388964.2
4.7 mm	388964.7
5.2 mm	388965.2
5.7 mm	388965.7
6.2 mm	388966.2

(s)	Art. no.
6.7 mm	388966.7
7.2 mm	388967.2
7.7 mm	388967.7
8.2 mm	388968.2
8.7 mm	388968.7

(s)	Art. no.
9.2 mm	388969.2
9.7 mm	388969.7
10.2 mm	3889610.2
10.7 mm	3889610.7
11.2 mm	3889611.2



Square die no. 45

(s)	Art. no.
11.7 mm	3889611.7
12.2 mm	3889612.2
12.7 mm	3889612.7
13.2 mm	3889613.2
13.7 mm	3889613.7
14.2 mm	3889614.2
14.7 mm	3889614.7
15.2 mm	3889615.2

(s)	Art. no.
15.7 mm	3889615.7
16.2 mm	3889616.2
16.7 mm	3889616.7
17.2 mm	3889617.2
17.7 mm	3889617.7
18.2 mm	3889618.2
18.7 mm	3889618.7
19.2 mm	3889619.2

(s)	Art. no.
19.7 mm	3889619.7
20.2 mm	3889620.2
20.7 mm	3889620.7
21.2 mm	3889621.2
21.7 mm	3889621.7
22.2 mm	3889622.2
22.7 mm	3889622.7
23.2 mm	3889623.2

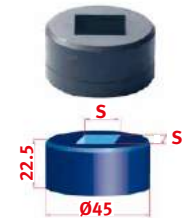

Square die no. 60

(s)	Art. no.
23.2 mm	3889623.2
23.7 mm	3889623.7
24.2 mm	3889624.2
24.7 mm	3889624.7
25.2 mm	3889625.2

(s)	Art. no.
25.7 mm	3889625.7
26.2 mm	3889626.2
26.7 mm	3889626.7
27.2 mm	3889627.2
27.7 mm	3889627.7

(s)	Art. no.
28.2 mm	3889628.2
28.7 mm	3889628.7
29.2 mm	3889629.2

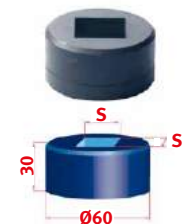

Square die no. 80*

(s)	Art. no.
28.7 mm	3889628.7
29.2 mm	3889629.2
29.7 mm	3889629.7
30.2 mm	3889630.2
30.7 mm	3889630.7

(s)	Art. no.
31.2 mm	3889631.2
31.7 mm	3889631.7
32.2 mm	3889632.2
32.7 mm	3889632.7
33.2 mm	3889633.2

(s)	Art. no.
33.7 mm	3889633.7
34.2 mm	3889634.2
34.7 mm	3889634.7
35.2 mm	3889635.2
35.7 mm	3889635.7



The punches and dies are not suitable for machining stainless steel. Tools for stainless steel can be quoted for on request.
* Use not possible with standard HPS/HLS scope of delivery – custom accessory "Oversized punching unit" required

Intermediate and custom sizes on request (3889399)

! We are always happy to advise you on the subject of dies and punches, e.g.,

- ▶ Which punch matches which die?
- ▶ What size do I need for my application?
- ▶ What material can I punch?

Prices on request!
Contact:
+49 (0951) 96555-171
beratung@metallkraft.de



Bending

Compressing and stretching machines

SSG series - Compressing and stretching machine for use in workshops and on construction sites

- ▶ For manufacturing wheel arches, window frames, rain gutters or door edges for classic vehicles
- ▶ For stretching and compressing edge-bent sheet metal
- ▶ Clean, fast and low-noise work
- ▶ Incl. compression and stretching tools
- ▶ Fast and easy tool changes
- ▶ Easy to use

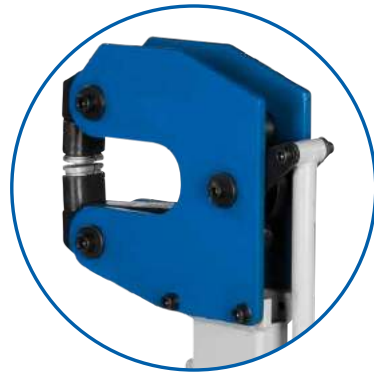

SSG 12

- ▶ Force transfer to tools via hand lever
- ▶ Figure shows scope of delivery



SSG 16

- ▶ Force transfer to tools via foot pedal
- ▶ Carriage unit for ease of transport



Compression jaw

Stretching jaw

Scope of delivery:

- > Basic machine
- > Compression jaws
- > Stretching jaws

Model	SSG 12	SSG 16
Art. no.	3776102	3776103
Technical specifications		
Max. sheet thickness	1.2 mm	1.5 mm
Throat	25 mm	153 mm
Dimensions in mm	150 x 50 x 140	1 175 x 410 x 920
Weight	5.5 kg	36 kg

* Dimensions without hand lever

Accessories

	Art.no.
Compression jaw SET for SSG 12	3776104
Stretching jaw SET for SSG 12	3776105
Compression jaw SET for SSG 16 for metal	3776106
Stretching jaw SET for SSG 16 for metal	3776107
Compression jaw SET for SSG 16 for aluminium	3776108
Stretching jaw SET for SSG 16 for aluminium	3776109

WB 100 – Angle bender for enthusiasts and trade professionals

- ▶ For precise cold and hot bending of flat, round and square steel
- ▶ Robust design for bolting onto the workbench
- ▶ Drill holes in cast bed for fastening to the workbench
- ▶ Infinitely adjustable bending stop
- ▶ With eccentric quick release for a rational style of work
- ▶ Bending angles up to 120°
- ▶ High level of repetition accuracy due to bending angle stop
- ▶ Ideal for repair workshops and smithies

Model	WB 100
Art. no.	3776101
€ plus VAT	259.00

Technical specifications

<i>Cold:</i>	
Flat steel	100 x 5 mm
Round steel bars	18 mm
Square steel bars	16 x 16 mm
Angle steel	60 x 8 mm
<i>Hot:</i>	
Flat steel	100 x 15 mm
Round steel bars	27 mm
Square steel bars	25 x 25 mm
Angle steel	100 x 12 mm
Dimensions	550 x 320 x 240 mm
Weight	30 kg

Scope of delivery:

- › Angle stop
- › Bending plate
- › Bending lever
- › Material stop

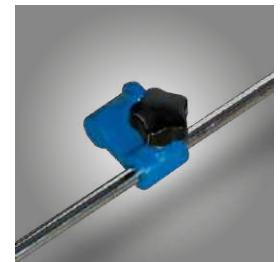
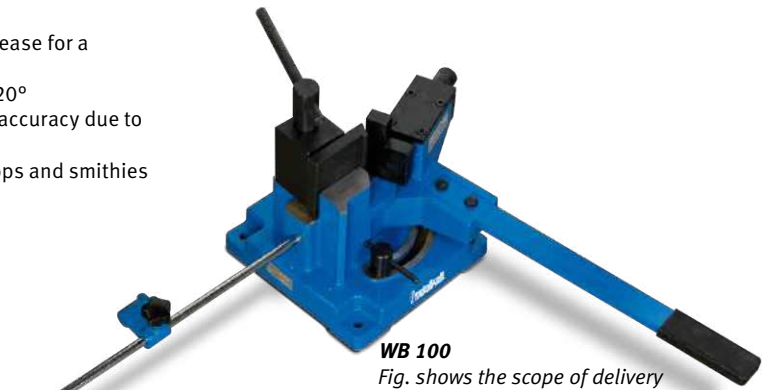

HRB 10 – Hydraulic pipe bender for universal application with 6 bending segments from 1/2" - 2"

- ▶ Universally deployable for heating, gas, boiling, water, copper and composite pipes
- ▶ Fold-up bending frame for convenient and rational operation
- ▶ With tripod stand for ergonomic work

Scope of delivery:

- › Six bending segments: 1/2", 3/4", 1", 1 1/4", 1 1/2", 2"
- › Tripod stand

Model	HRB 10
Art. no.	3777010
€ plus VAT	375.00

Technical specifications

Pressure output	10 t
Piston stroke	155 mm
Dimensions (L x W x H)	710 x 590 x 220 mm
Weight	45 kg

Bending possibilities

Bending segment	Pipe-Ø	Wall thickness	Bending radius	Bending angle
1/2"	20 mm	3,25 mm	62 mm	0-90 °
3/4"	25 mm	3,50 mm	78 mm	0-90 °
1"	32 mm	4,00 mm	98 mm	0-90 °
1 1/4"	40 mm	4,00 mm	128 mm	0-120 °
1 1/2"	47 mm	4,25 mm	148 mm	0-120 °
2"	59 mm	4,50 mm	187 mm	0-120 °

Accessories

Bending segment	Pipe diameter	Wall thickness	Bending radius	Bending angle	Art. no.	€ plus VAT
1/2"	20 mm	3.25 mm	62 mm	0-90 °	3777011	10.90
3/4"	25 mm	3.50 mm	78 mm	0-90 °	3777012	14.00
1"	32 mm	4.00 mm	98 mm	0-90 °	3777013	19.00
1 1/4"	40 mm	4.00 mm	128 mm	0-120 °	3777014	25.90
1 1/2"	48.0 mm	4.25 mm	148 mm	0-120 °	3777015	37.50
2"	60.0 mm	4.50 mm	187 mm	0-120 °	3777016	59.90

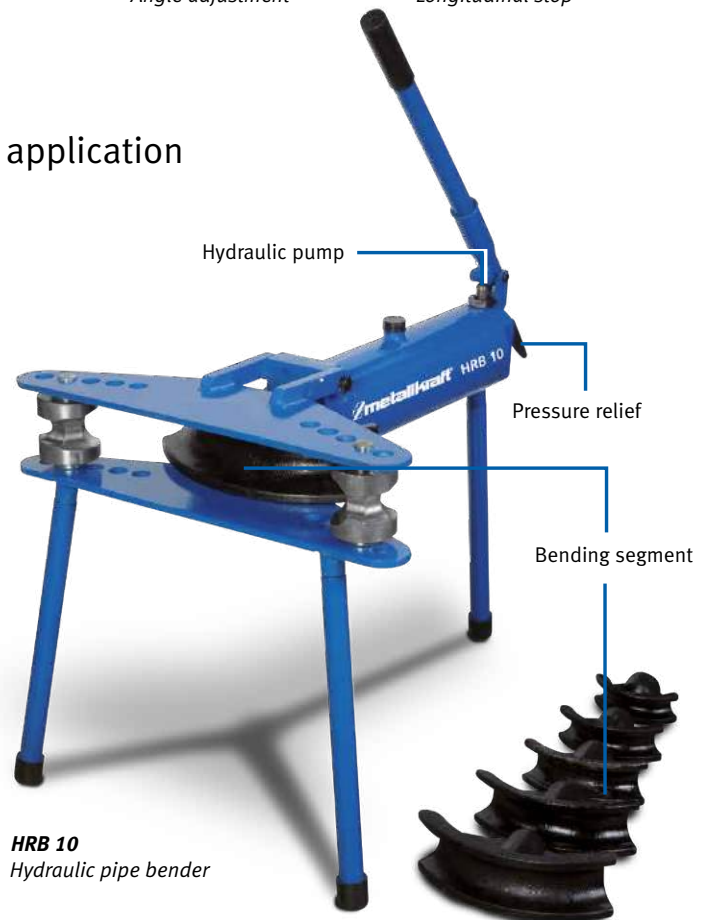

Mobile universal bending machine

UB 10 – Universal bending machine for angled, round and helical bending of flat and square materials

- ▶ Cold bending up to an angle of 180°
- ▶ Adjustable bending angle stop for a high level of repetition accuracy
- ▶ Also for helical bending with the UB 11 option
- ▶ With bolt-on base for the workshop

- ▶ Easily transportable, and thus ideal for workshop, on site and in the service vehicle
- ▶ Removable bending unit with optional clamping plate can also be deployed on a vice



- ▶ Hardened hinges and bearings
- ▶ Bending angle stop



- ▶ Angle for bending sharp edges in flat materials
- ▶ 4 positioning bolts hold the workpiece

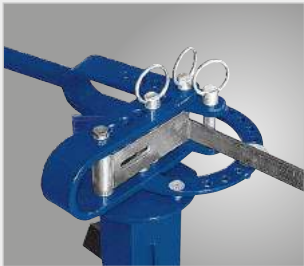

- ▶ Application flat materials: acute bending



- ▶ Two sets of tempered bending rollers in scope of supply



- ▶ Plate rolling in flat materials

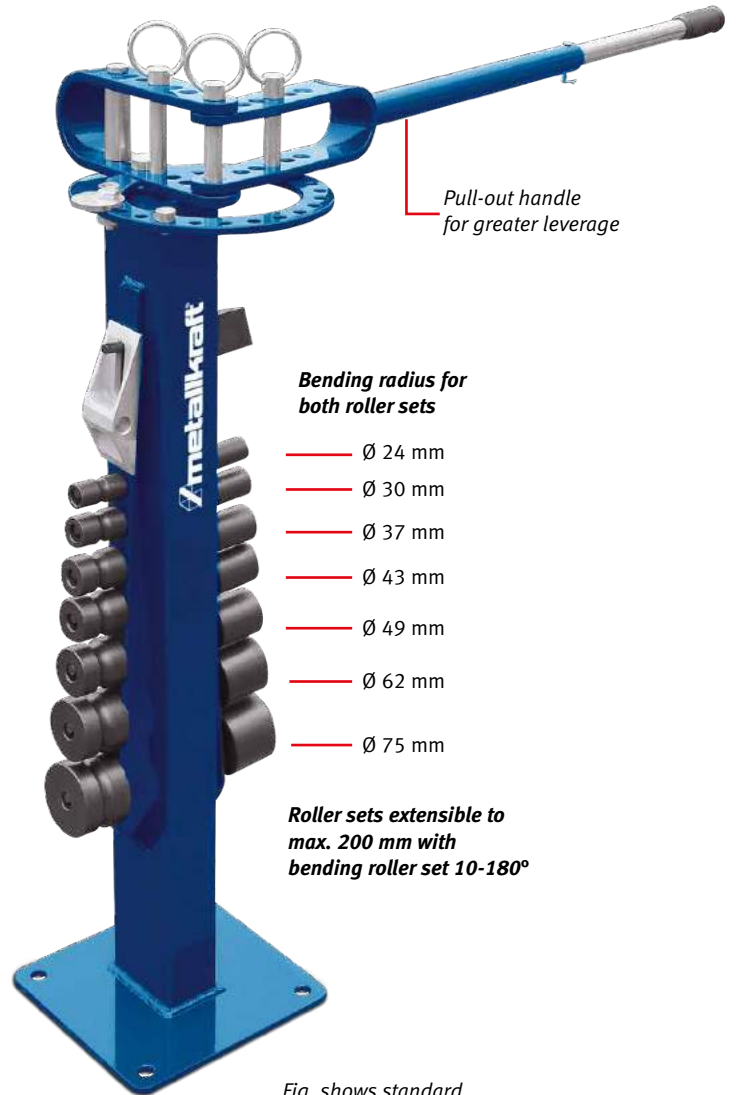
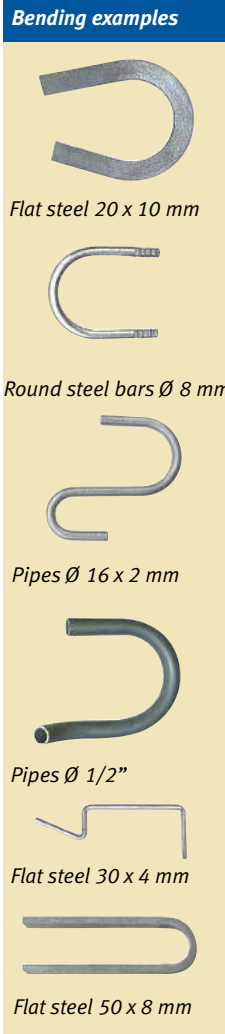

Pull-out handle for greater leverage

Bending radius for both roller sets

- Ø 24 mm
- Ø 30 mm
- Ø 37 mm
- Ø 43 mm
- Ø 49 mm
- Ø 62 mm
- Ø 75 mm

Roller sets extensible to max. 200 mm with bending roller set 10-180°

Fig. shows standard scope of delivery

Model	UB 10	
Art. no.	3776010	
Technical specifications		
Max. bending dimension		
Flat steel: plate rolling	10 x 50 mm	
Flat steel: acute bending	6 x 50 mm	
Weight	32 kg	
Material	Steel/Aluminium/Copper	stainless steel
Round materials	Ø 16 mm	Ø 14 mm
Square materials	16 x 16 mm*	14 x 14 mm*
Pipes	T 3/4"	

* Bending elements optionally available

Scope of delivery:

- ▶ Bending rollers: 2 x Ø 24/30/37/43/49/62/75 mm

Optional accessories UB 10

Model Art. no.
Heating pipe bending roller set 3790001

- ▶ For cold bending of heating pipes of sizes G3/8", G1/2", G3/4".
- ▶ Set consists of 2 items per size.
- Weight 15 kg

Inner diameter for bend

- ▶ G 3/8" 102 mm
 - ▶ G 1/2" 108 mm
 - ▶ G 3/4" 112 mm
- ▶ *Grey cast iron*
- ▶ *Galvanised steel*

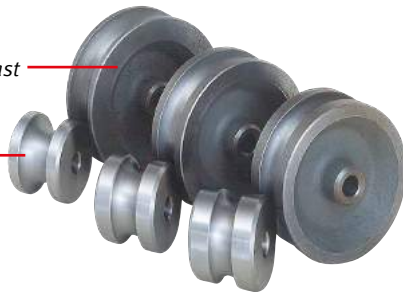

Bending rollers specially for pipes

Bending roller set 10-180 3790002

- ▶ For bending strip steel up to 50 mm width and 7 mm thickness and square materials up to 16 x 16 mm
- ▶ Ideal for smithing work
- ▶ Set consists of 8 bending rollers
- ▶ Extends the bending capacity to Ø 110, 150, 175, 200 mm
- ▶ Weight 33 kg



Adjustable stop 10-200 3790003

- ▶ Universal, adjustable stop
- ▶ For small batch work



Clamping plate 3790004

- ▶ For mounting the non-mounted bending unit of the UB 10 on a commercially available vice
- ▶ As a simple solution on site, without needing to dismantle the base of the UB 10 and take it with you
- ▶ Also usable for RB 30
- ▶ Weight 1.5 kg
- ▶ Supplied without vice



Conversion kit for UB 10 to RB 30 3790006

- ▶ For bending thin-walled pipes
- ▶ With bending elements, angle element and guides
- ▶ Installation through replacing the bending elements
- ▶ Bending elements 6 pcs.: Ø 14, 16, 18, 20, 22, 25 mm
- ▶ Weight: 31 kg



Accessories/bending segments from Page 97 usable

Helical bending element UB 11

- ▶ Add-on part for helical bending on the UB 10

- ▶ *Small helix can be used independently*

- ▶ *Supporting roller*

- ▶ *Easily attachable large bending segment*

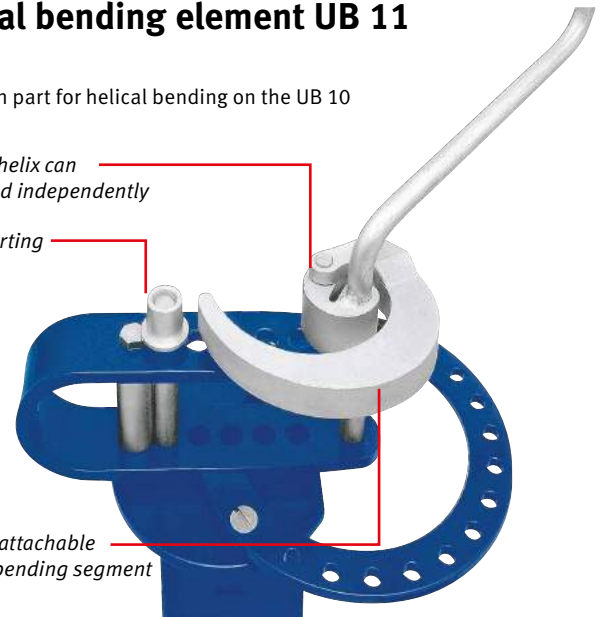

Bending examples



Large helixes

Small helixes

Model Helical bending element UB 11
Art. no. 3790011

Technical specifications

Max. material thicknesses

Square	5 x 5 mm
Flat materials	5 x 25 mm
Round materials	Ø 5 mm
Weight	3 kg

Separate holding handle for helical bending element UB 11 allows operation of the UB 11 without the UB 10 on a commercially available vice



Fig. shows the scope of delivery UB10-280

Model UB 10-280
Art. no. 3790280

Mobile pipe bending machines

RB 30 – Pipe bender for cold bending of thin-walled pipes made of brass, copper, steel and other materials

- ▶ Easy cold bending of thin-walled pipes without support elements
- ▶ For bending simple and complex shapes
- ▶ Pull-out handle for greater leverage
- ▶ Easily transportable, ideal for workshop, on site and in the service vehicle
- ▶ Removable bending unit with optional clamping plate can also be deployed on a vice
- ▶ With bolt-on base for the workshop
- ▶ More bending segments



- ▶ A special coating on the guide prevents damage to the pipes
- ▶ Fastening screw

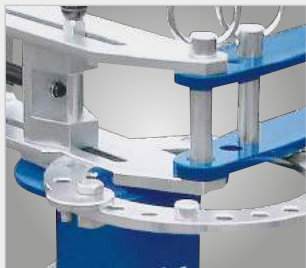

- ▶ Bending angle stop for a high level of repetition accuracy
- ▶ Tempered bearings

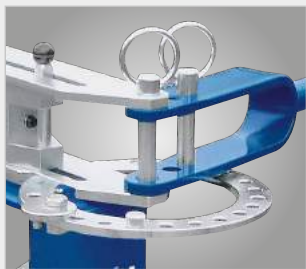

- ▶ Tempered bolts



- ▶ Space-saving and tidy storage of the bending segments on the base

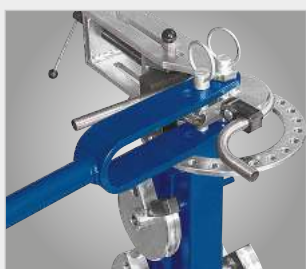

- ▶ Example of combined bending

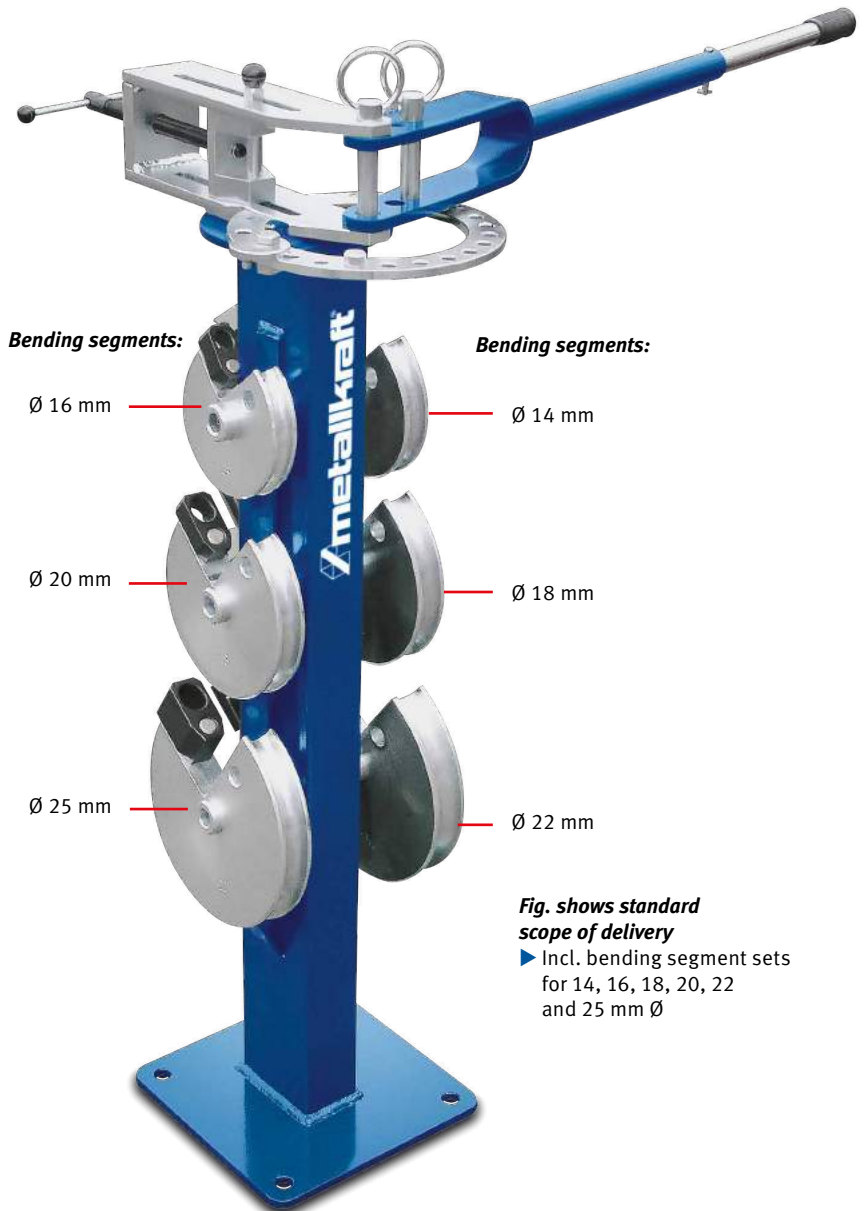
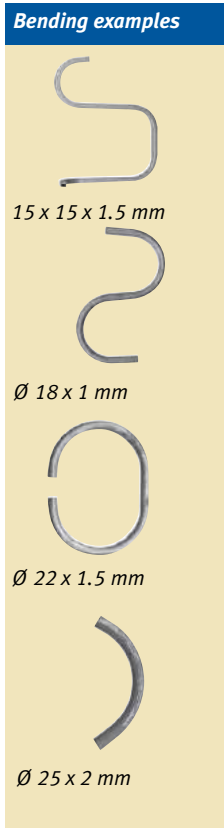

Fig. shows standard scope of delivery
 ▶ Incl. bending segment sets for 14, 16, 18, 20, 22 and 25 mm Ø

Bending radius standard segments

Size	Radius
Ø14	56 mm
Ø16	64 mm
Ø18	72 mm
Ø20	80 mm
Ø22	88 mm
Ø25	100 mm

Model	RB 30	
Art. no.	3776030	
Technical specifications		
Bending radius standard	4 x Ø of pipe, 56 - 100 mm	
max. wall thickness (Ø 25 mm)	2 mm	
Material	Steel/Aluminium/Copper	stainless steel
Round materials	Ø 25 x 2 mm	Ø 22 x 2 mm
Square materials	20 x 20 x 2 mm*	

* Bending elements optionally available

Accessories/bending segments from Page 97 usable

Scope of delivery:
 > Bending segments 6 pcs.:
 Ø 14, 16, 18, 20, 22, 25 mm

Additional bending segments

Accessories - bending segment sets (with sliding piece and holder)

Designation	Diameter	Radius	Art. no.
Set Ø 6 R40	6 mm	40 mm	3790105
Set Ø 8 R42	8 mm	42 mm	3790020
Set Ø 10 R42	10 mm	42 mm	3790021
Set Ø 12 R45	12 mm	45 mm	3790022
Set Ø 14 R42	14 mm	42 mm	3790023
Set Ø 14 R56	14 mm	56 mm	3790024
Set Ø 15 R45	15 mm	45 mm	3790025
Set Ø 16 R40	16 mm	40 mm	3790026
Set Ø 16 R48	16 mm	48 mm	3790027
Set Ø 16 R64	16 mm	64 mm	3790028
Set Ø 18 R45	18 mm	45 mm	3790029
Set Ø 18 R54	18 mm	54 mm	3790030
Set Ø 18 R72	18 mm	72 mm	3790031
Set Ø 20 R50	20 mm	50 mm	3790032
Set Ø 20 R60	20 mm	60 mm	3790033
Set Ø 20 R80	20 mm	80 mm	3790034
Set Ø 22 R55	22 mm	55 mm	3790035
Set Ø 22 R66	22 mm	66 mm	3790036
Set Ø 22 R88	22 mm	88 mm	3790037
Set Ø 25 R62.5	25 mm	62.5 mm	3790038
Set Ø 25 R75	25 mm	75 mm	3790039
Set Ø 25 R100	25 mm	100 mm	3790040
Dimensions			
Square set 15x15 R45	15 x 15 mm	45 mm	3790041
Square set 20x20 R60	20 x 20 mm	60 mm	3790042

Accessories - bending segment

for RB 30, UB 10 and ERB 60 (bending segment only)

Designation	Diameter	Radius	Art. no.
Segment Ø14 R42	14 mm	42 mm	3790043
Segment Ø16 R40	16 mm	40 mm	3790044
Segment Ø16 R48	16 mm	48 mm	3790045
Segment Ø18 R45	18 mm	45 mm	3790046
Segment Ø18 R54	18 mm	54 mm	3790047
Segment Ø20 R50	20 mm	50 mm	3790048
Segment Ø20 R60	20 mm	60 mm	3790049
Segment Ø22 R55	22 mm	55 mm	3790050
Segment Ø22 R66	22 mm	66 mm	3790051
Segment Ø25 R62.5	25 mm	62.5 mm	3790052
Segment Ø25 R75	25 mm	75 mm	3790053

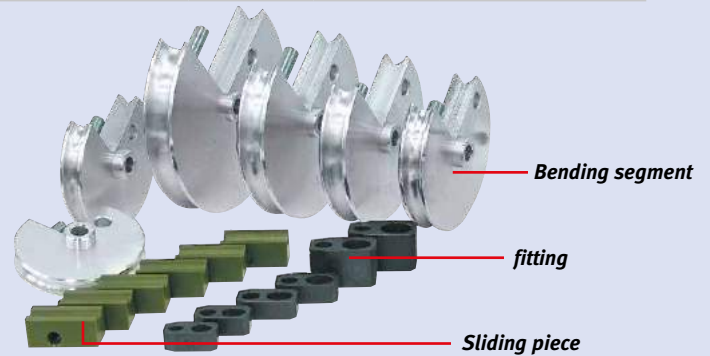

Extension plate RB 30

- ▶ Offsets the bending axis to outside the base
- ▶ Allows for bending of long workpieces



Model	Extension plate RB 30
Art. no.	3790005

Bending unit RB 12 for heating pipes and water pipes up to G3/4"

- ▶ Ideal for on the road
- ▶ Easy assembly on a commercially available vice
- ▶ Cold bending up to an angle of 180°
- ▶ Partial bending supported
- ▶ Adjustable bending angle stop for a high level of repetition accuracy
- ▶ Easy to use

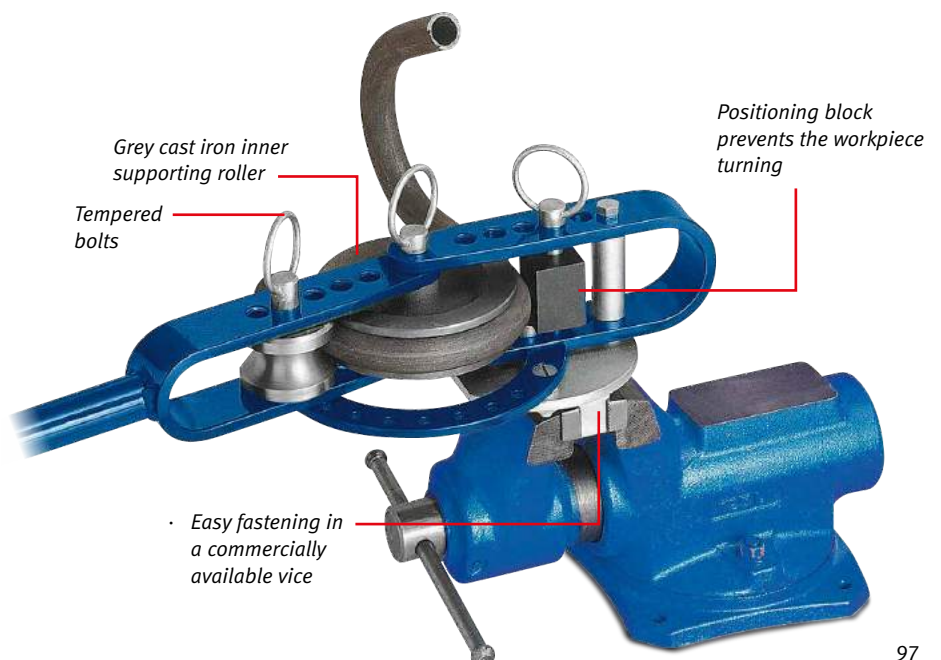

Model	RB 12
Art. no.	3776012

Technical specifications	
Inner diameter for bend G 3/8"	102 mm
Inner diameter for bend G 1/2"	108 mm
Inner diameter for bend G 3/4"	112 mm
Weight	22 kg

Hydraulic horizontal bending press

HBP series – Hydraulic, universally deployable horizontal bending presses with NC control for immersion depth

- ▶ For precise bending of tubular and solid material
- ▶ Durable design of the tools and tool guides in premium, tempered steel
- ▶ Manual operation via two foot pedals for forward and reverse
- ▶ Automatic operation by programming the front and rear positioning endpoints
- ▶ Easy die change thanks to quick release mount
- ▶ Foot pedal with digital display and emergency stop switch



HBP 20



- ▶ Control panel with digital display and EMERGENCY STOP switch

- › Robust machine design
- › Manual and automatic mode selectable
- › Easy tool changing thanks to quick release system

Scope of supply	HBP 10	HBP 20	HBP 30	HBP 40
Bending die				
68°; Height = 200 mm; R = 5 mm	X	X		
68°; Height = 250 mm; R = 5 mm	X	X	X	
60°; Height = 150 mm; R = 6 mm				X
Quick change die 60°				
Height = 150 mm; V = 60 mm	X	X		
Height = 250 mm; V = 60 mm	X	X		
Height = 250 mm; V = 60 mm			X	
Height = 150 mm; V = 60 mm				X
Foot pedal with digital display	X	X	X	X
Lateral stop 300 mm	X	X	X	X

Model	HBP 10	HBP 20	HBP 30	HBP 40
Art. no.	3812510	3812520	3812530	3812540

Technical specifications	HBP 10	HBP 20	HBP 30	HBP 40
Max. press force	10 t	20 t	30 t	40 t
Oil tank capacity	12 l	12 l	40 l	40 l
Bending performance flat material	150 x 8 mm	200 x 12 mm	250 x 18 mm	250 x 24 mm
Bending performance tubular material	42 x 3.2 mm	48 x 4.0 mm	60 x 4.0 mm	60 x 5.0 mm
Max. stroke	185 mm	185 mm	285 mm	285 mm
Bolt diameter	60 mm	80 mm	80 mm	80 mm
Tool height	150 mm	200 mm	250 mm	250 mm
Working speed	10 mm/s	10 mm/s	10 mm/s	10 mm/s
Return speed	10 mm/s	10 mm/s	10 mm/s	10 mm/s
Table length	450 mm	480 mm	660 mm	660 mm
Table width	900 mm	1 060 mm	1 250 mm	1 250 mm
Working height	915 mm	930 mm	930 mm	930 mm
Motor output	1.1 kW	2.2 kW	3 kW	4 kW
Length	900 mm	1 150 mm	1 250 mm	1 250 mm
Width/depth	450 mm	480 mm	650 mm	650 mm
height	1 130 mm	1 200 mm	1 250 mm	1 250 mm
Weight	250 kg	530 kg	1 050 kg	1 050 kg



► With quick release mount and side stop with scale



► Hydraulic pressure adjustable

Pipe bending tools to match all HBP models

	Art. no.
Bending frame and counterholder for pipe bending tools	3888060
Grey cast bending segment 3/8"	3888061
Grey cast bending segment 1/2"	3888062
Grey cast bending segment 3/4"	3888063
Grey cast bending segment 1"	3888064
Grey cast bending segment 1 1/4"	3888065
Grey cast bending segment 1 1/2"	3888066
Grey cast bending segment 2"	3888067

Tempered and polished bending tools (for HBP 10)

Die 85°, H = 150 mm, R = 1 mm	3888101
Die 85°, H = 150 mm, R = 5 mm	3888102
Die 85°, H = 150 mm, R = 10 mm	3888103
Die 30°, H = 150 mm, R = 5 mm	3888104
Bending mandrel 25 x 25 mm - load bearing capacity 6 t/m	3888105
Bending mandrel 30 x 30 mm - load bearing capacity 10 t/m	3888106
Bending mandrel 40 x 40 mm - load bearing capacity 25 t/m	3888107
Quick change multiple die 85°, H = 150 mm	3888120
V = 16/22/35/50 mm, max. material thickness 4 mm	
Quick change mono die 85°, H = 150, V = 63 mm	3888121
Quick change mono die 85°, H = 150, V = 80 mm	3888122
Quick change mono die 85°, H = 150, V = 100 mm	3888123
Quick change mono die 85°, H = 150, V = 125 mm	3888124
Quick change mono die 85°, H = 150, V = 160 mm	3888125
Quick change mono die 45°, H = 150, V = 50 mm	3888126

Bending tool for flat material (for HBP 10)

Bending frame and counterholder	3888150
Bending tool for flat material incl. pins and washers for material 4/6/8 mm	3888151

Straightening tools (for HBP 10)

Straightening beam approx. 800 mm with counterbearing and straightening die	3888155
---	---------

Tempered and polished bending tools (for HBP 20)

Die 85°, H = 200 mm, R = 1 mm	3888201
Die 85°, H = 200 mm, R = 5 mm	3888202
Die 85°, H = 200 mm, R = 10 mm	3888203
Die 30°, H = 200 mm, R = 5 mm	3888204
Bending mandrel 25 x 25 mm - load bearing capacity 6 t/m	3888205
Bending mandrel 30 x 30 mm - load bearing capacity 10 t/m	3888206
Bending mandrel 40 x 40 mm - load bearing capacity 25 t/m	3888207
Quick change multiple die 85°, H = 200 mm	3888220
V = 16/22/35/50 mm, max. material thickness 4 mm	
Quick change mono die 85°, H = 200, V = 63 mm	3888221
Quick change mono die 85°, H = 200, V = 80 mm	3888222
Quick change mono die 85°, H = 200, V = 100 mm	3888223
Quick change mono die 85°, H = 200, V = 125 mm	3888224
Quick change mono die 85°, H = 200, V = 160 mm	3888225

Quick change mono die 45°, H = 200, V = 50 mm	3888226
---	---------

Bending tool for flat material (for HBP 20)

Bending frame and counterholder	3888250
Bending tool for flat material incl. pins and washers for material 4/6/8 mm	3888251

Straightening tools (for HBP 20)

Straightening beam approx. 800 mm with counterbearing and straightening die	3888255
---	---------

Tempered and polished bending tools (for HBP 30/40)

	Art. no.
Die 85°, H = 250 mm, R = 1 mm	3888301
Die 85°, H = 250 mm, R = 5 mm	3888302
Die 85°, H = 250 mm, R = 10 mm	3888303
Die 30°, H = 250 mm, R = 5 mm	3888304
Bending mandrel 25 x 25 mm - load bearing capacity 6 t/m	3888305
Bending mandrel 30 x 30 mm - load bearing capacity 10 t/m	3888306
Bending mandrel 40 x 40 mm - load bearing capacity 25 t/m	3888307
Bending mandrel 50 x 50 mm - load bearing capacity 45 t/m	3888308
Quick change multiple die 85°, H = 250 mm	3888320
V = 16/22/35/50 mm, max. material thickness 4 mm	
Quick change mono die 85°, H = 250, V = 63 mm	3888321
Quick change mono die 85°, H = 250, V = 80 mm	3888322
Quick change mono die 85°, H = 250, V = 100 mm	3888323
Quick change mono die 85°, H = 250, V = 125 mm	3888324
Quick change mono die 85°, H = 250, V = 160 mm	3888325
Quick change mono die 45°, H = 250, V = 50 mm	3888326

Bending tool for flat material (for HBP 30/HBP 40)

Bending frame and counterholder	3888350
Bending tool for flat material incl. pins and washers for material 4/6/8 mm	3888351

Straightening tools (for HBP 30/HBP 40)

Straightening beam approx. 800 mm with counterbearing and straightening die	3888355
---	---------

Hydraulic horizontal bending press

New

HBP series – Hydraulic, universally deployable horizontal bending presses with NC control for immersion depth

- ▶ For precise bending of tubular and solid material
- ▶ Durable design of the tools and tool guides in premium, tempered steel
- ▶ Manual operation via two foot pedals for forward and reverse
- ▶ Automatic operation by programming the front and rear positioning endpoints
- ▶ Easy die change thanks to quick release mount
- ▶ Foot pedal with digital display and emergency stop switch



▶ Control panel with digital display and EMERGENCY STOP switch

Scope of supply	HBP 50	HBP 80	HBP 100
Bending die			
68°; Height = 300 mm; R = 5 mm	X	X	X
Quick change die 60°			
Height = 300 mm; V = 60 mm	X	X	X
Foot pedal with digital display	X	X	X
Lateral stop 300 mm	X	X	X

- › Robust machine design
- › Manual and automatic mode selectable
- › Easy tool changing thanks to quick release system

Model	HBP 50	New HBP 80	New HBP 100
Art. no.	3812550	3812580	3812599

Technical specifications	HBP 50	HBP 80	HBP 100
Max. press force	50 t	80 t	100 t
Oil tank capacity	60 l	120 l	120 l
Bending performance flat material	300 x 15 mm	300 x 20 mm	300 x 25 mm
Bending performance tubular material	76 x 4 mm	90 x 9 mm	114 x 8 mm
Max. stroke	285 mm	285 mm	285 mm
Bolt diameter	90 mm	105 mm	105 mm
Tool height	300 mm	300 mm	300 mm
Working speed	10 mm/s	10 mm/s	10 mm/s
Return speed	10 mm/s	10 mm/s	10 mm/s
Table length	600 mm	750 mm	750 mm
Table width	1 250 mm	1 425 mm	1 425 mm
Working height	930 mm	930 mm	930 mm
Motor output	7.5 kW	10 kW	10 kW
Length	1 400 mm	1 430 mm	1 430 mm
Width/depth	600 mm	750 mm	750 mm
Height	1 500 mm	1 450 mm	1 450 mm
Weight	1 450 kg	1 700 kg	1 700 kg

New



► With quick release mount and side stop with scale



► Hydraulic pressure adjustable

Pipe bending tools (to match all HBP models)	Art. no.
Grey cast bending segment 3/8"	3888061
Grey cast bending segment 1/2"	3888062
Grey cast bending segment 3/4"	3888063
Grey cast bending segment 1"	3888064
Grey cast bending segment 1 1/4"	3888065
Grey cast bending segment 1 1/2"	3888066
Grey cast bending segment 2"	3888067
Pipe bending tools (for HBP 50)	
Bending frame and counterholder for pipe bending tools	3888060
Pipe bending tools (for HBP 80/100)	
Bending frame and counterholder for pipe bending tools	3888070
Tempered and polished bending tools (for HBP 50)	
Die 85°, H = 300 mm, R = 1 mm	3888501
Die 85°, H = 300 mm, R = 5 mm	3888502
Die 85°, H = 300 mm, R = 10 mm	3888503
Die 30°, H = 300 mm, R = 5 mm	3888504
Bending mandrel 25 x 25 mm - load bearing capacity 6 t/m	3888505
Bending mandrel 30 x 30 mm - load bearing capacity 10 t/m	3888506
Bending mandrel 40 x 40 mm - load bearing capacity 25 t/m	3888507
Bending mandrel 50 x 50 mm - load bearing capacity 45 t/m	3888508
Bending mandrel 60 x 60 mm - load bearing capacity 80 t/m	3888509
Quick change multiple die 85°, H = 300 mm	3888520
V = 16/22/35/50 mm, max. material thickness 4 mm	
Quick change mono die 85°, H = 300, V = 63 mm	3888521
Quick change mono die 85°, H = 300, V = 80 mm	3888522
Quick change mono die 85°, H = 300, V = 100 mm	3888523
Quick change mono die 85°, H = 300, V = 125 mm	3888524
Quick change mono die 85°, H = 300, V = 160 mm	3888525
Quick change mono die 45°, H = 300, V = 50 mm	3888526
Bending tool for flat material (for HBP 50)	
Bending frame and counterholder	3888550
Bending tool for flat material incl. pins and washers for material 4/6/8 mm	3888551
Straightening tools (for HBP 50)	
Straightening beam approx. 800 mm with counterbearing and straightening die	3888555

Tempered and polished bending tools (for HBP 80/100)	Art. no.
Die 85°, H = 300 mm, R = 1 mm	3888801
Die 85°, H = 300 mm, R = 5 mm	3888802
Die 85°, H = 300 mm, R = 10 mm	3888803
Die 30°, H = 300 mm, R = 5 mm	3888804
Bending mandrel 25 x 25 mm - load bearing capacity 6 t/m	3888805
Bending mandrel 30 x 30 mm - load bearing capacity 10 t/m	3888806
Bending mandrel 40 x 40 mm - load bearing capacity 25 t/m	3888807
Bending mandrel 50 x 50 mm - load bearing capacity 45 t/m	3888808
Bending mandrel 60 x 60 mm - load bearing capacity 80 t/m	3888809
Quick change multiple die 85°, H = 300 mm	3888820
V = 16/22/35/50 mm, max. material thickness 4 mm	
Quick change mono die 85°, H = 300, V = 63 mm	3888821
Quick change mono die 85°, H = 300, V = 80 mm	3888822
Quick change mono die 85°, H = 300, V = 100 mm	3888823
Quick change mono die 85°, H = 300, V = 125 mm	3888824
Quick change mono die 85°, H = 300, V = 160 mm	3888825
Quick change mono die 45°, H = 300 mm	3888826
V = 50 mm, max. material thickness 5 mm	
Bending tool for flat material (for HBP 80/100)	
Bending frame and counterholder	3888850
Bending tool for flat material incl. pins and washers for material 4/6/8 mm	3888851
Straightening tools (for HBP 80/100)	
Straightening beam approx. 800 mm with counterbearing and straightening die	3888855

Magnetic drilling
Deburring
Metal grinding
Cutting
Notching & punching
Bending
Presses
Circular saws
Roller conveyors
Metal-cutting band saws

Pipe bending machines without mandrels

RB series – NC-controlled with large program memory

- ▶ NC control for adjusting the bending angle
- ▶ Premium, rugged design
- ▶ Up to 50 program memory slots
- ▶ Fast tool change
- ▶ Motorised drive only
- ▶ Automatically moves to starting position



RB 42



Fig. shows RB 42 with optional chassis

Model	RB 42	RB 54
Art. no.	4300042	4300054
Technical specifications		
Bending performance tubular material 420 N/mm ²	Ø 42 x 3 mm	Ø 54 x 4 mm
Bending performance tubular material 350 N/mm ²	Ø 42 x 3 mm	Ø 54 x 4 mm
Bending performance tubular material 650 N/mm ²	Ø 30 x 2 mm	Ø 42 x 3 mm
Max. bending radius	100 mm	125 mm
Max. bending angle	180°	180°
Bending speeds	2 rpm	2 rpm
Torque	2 341 Nm	2 341 Nm
Main motor	0.55 kW	1.1 kW
Electrical connection	400 V / 40 Hz	400 V / 40 Hz
Dimensions (L x W x H)	600 x 180 x 450 mm	600 x 220 x 470 mm
Weight	94 kg	107 kg



RB 54
Figure shows optional chassis



Accessories	RB 42	RB 54	Art. no.
Chassis	X	X	4310000
Bending segments consisting of:	RB 42	RB 54	Art. no.
1 bending segment, 2 counter rollers and 1 ring	X	X	
Bending segment 1/4" T (13.72 mm) R 37.6	X	X	4310005
Bending segment 1/2" T (21.3 mm) R 59.2	X	X	4310006
Bending segment 3/4" T (26.9 mm) R 80	X	X	4310007
Bending segment 1" W (25.4 mm) R 80	X	X	4310008
Bending segment 1" T (33.7 mm) R 100.1	X	X	4310009
Bending segment 1 1/4" W (38.1 mm) R 100.1	X	X	4310010
Bending segment 1 1/2" W (38.1 mm) R 126		X	4310015
Bending segment 1 1/2" W (38.1 mm) R 152		X	4310016
Bending segment 1 1/2" T (43.8 mm) R 152		X	4310019
Bending segment 1 1/4" T (42.25 mm) R 127.4		X	4310018
Bending segment 2" W (50.8 mm) R 195		X	4310017
Sliding shoes	RB 42	RB 54	Art. no.
1/2" T (Ø21.7 mm) x 3/8" T (Ø17.3 mm)	X	X	4310050
1/4" T (Ø13.8 mm) x 1/8" T (Ø10.5 mm)	X	X	4310051
1" T (Ø34 mm) x 3/4" T (Ø27.2 mm)	X	X	4310052
1" W (Ø35.4 mm) x 1 1/4" W (Ø31.8 mm)	X	X	4310053
1 1/4" W (Ø31.8 mm) x 1 1/2" W (Ø 38.1 mm)	X	X	4310054
1 1/4" T (Ø42.25 mm)		X	4310055
1 1/2" W (Ø38.1 mm) x 2" W (Ø50.8 mm)		X	4310056
1 1/2" T (Ø43.8 mm)		X	4310057

Pipe bending machines without mandrels

BM series – Pipe bending machines without mandrels



- ▶ High-quality, compact and very durable design
- ▶ NC control to adjust bending angles and correction
- ▶ Standard control **SIMPLY**: Enter an angle and a correction value (standard with *BM 34-S*, *BM 42-SP*, *BM 42-SA*, *BM 48-S*, *BM 60-S*, *BM 76-S*)
- ▶ Optional control **EXPERT**: supports entry of bending sequences and storing programs (standard with *BM 100-E*, *BM 125-E*, *BM 150-E*, *BM 200-E*)
- ▶ High torque thanks to powerful motor with inverter and reduction gear
- ▶ Smart tooling system supporting left and right bending with the same tool – **PATENTED!**
- ▶ Easy removal of bent pipes from the sliding block using innovative spring system – **PATENTED!**
- ▶ Cost-effective wear parts
- ▶ Very short, straight pipe end thanks to optimised tool geometry
- ▶ Change the attachment shaft to use bending tools made by other machine manufacturers.
- ▶ Lower head bending (suitable for *BM 42-SP*, *42-SA*, *48-S*, *60-S* and *76-S* models)
- ▶ Two bending speeds, can be selected using a rotary switch
- ▶ Manually pipe clamping with hand wheel, with counter to ensure high degree of reproducibility
- ▶ Mobile, manual control panel optionally available
- ▶ Low-noise, clean, and temperature-independent work thanks to motorised only drive

Patented tool system

Lower head bending

Bending in anti-clockwise/clockwise direction using the same tool kit

Fully driven by the motor – no hydraulics



SIMPLY/EXPERT control



BM 34-S



BM 42-SP



BM 42-SA



BM 48-S

Model		BM 34-S	BM 42-SP	BM 42-SA	BM 48-S	BM 60-S	BM 76-S	BM 100-E	BM 125-E	BM 150-E	BM 200-E
Art. no.		3960032	3960042	3960043	3960048	3960060	3960076	3961100	3961125	3961150	3961200
Technical specifications											
Bending performance											
Ø x wall thickness (420N/mm ²)	mm	33.4 x 3.4	42 x 3	42 x 3	48 x 3.5	60 x 4	76 x 3	101.6 x 5.74	114.3 x 8.56	141.3 x 9.52	168.3 x 10.97
Ø x wall thickness (350N/mm ²)	mm	38 x 2	48 x 1.5	48 x 1.5	48 x 4	64 x 5	70 x 5	114.3 x 4.78	141.3 x 6.55	168.3 x 7.11	219.1 x 6.35
Ø x wall thickness (650N/mm ²)	mm	33.4 x 1.5	42 x 1.5	42 x 1.5	48 x 2	64 x 3	70 x 4	88.9 x 4.78	114.3 x 4.78	141.3 x 6.55	168.3 x 7.11
Ø solid material (420N/mm ²)	mm	22	30	30	34	42	46	-	-	-	100
Max. bending radius	mm	170	260	260	260	380	380	600	700	850	1 100
Max. bending angle	°	180	180	180	180	180	180	180	180	180	180
Bending speeds	rpm	2 and 3	2 and 3	2 and 3	2 and 3	1 and 2	1 and 2	1 and 2	0.98	1	0.8
Torque	Nm	914	1 800	1 800	2 400	8 000	10 000	22 000	37 000	70 000	115 000
Bending head projection (C x T)	mm	-	240 x 245	620 x 310	620 x 310	515 x 364	464 x 390	-	-	-	-
Bending head height (A)	mm	-	188	188	188	268	315	-	-	-	-
Variant		Portable					Stationary				
Motor output	kW	0.55	0.75	0.75	1.1	1.5	1.8	3	4	7.5	11
Electrical connection	V/Hz	230/50	230/50	230/50	400/50	400/50	400/50	400/50	400/50	400/50	400/50
Weight (approx.)	kg	33	90	110	110	210	306	900	1 200	1 500	2 200
Dimensions											
Length (L)	mm	478	655	700	700	1 000	1 000	800	800	1 000	1 850
Width (B)	mm	268	347	440	440	680	680	1 100	1 200	1 200	1 200
Height (H)	mm	310	550	970	970	1 100	1 100	1 300	1 400	1 600	1 350
options											
Positioning unit 3 m or 6 m		-	-	0	0	0	0	0	0	0	0
Motor-driven deburring unit		-	-	-	0	0	0	-	-	-	-
Expert controls		-	-	0	0	0	0	-	-	-	-



Custom accessories

- ▶ Positioning units for 3 000 mm or 6 000 mm with continuously adjustable stop cams and scale to set the longitudinal position
- ▶ Three jaw chuck with stop cams and angle scale
- ▶ To adjust rotations (available for BM 42-SA, 48-S, 60-S, 76-S 110-S, 140-S and 200-E models)
- ▶ Motorised deburring tool (available for BM 48-S, 60-S, 76-S, 100-E, 125E, 150-E und 200-E models)
- ▶ Tool sets for G pipes, OD inch pipes, individual, metric dimensions as well as profiles and flat steel
- ▶ "Expert control" for entering bending sequences and saving programs



BM 60-S



BM 76-S



BM 200-E

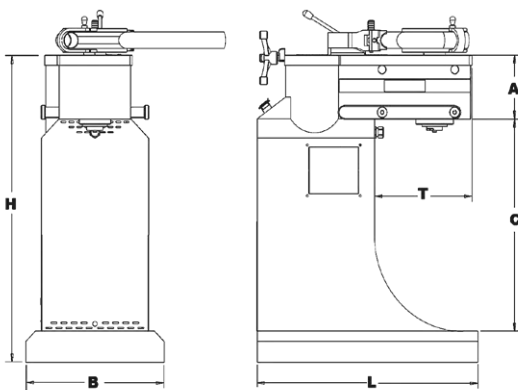

Accessories

	Art. no.
3 m positioning units for BM 42/BM 48	3973001
3 m positioning units for BM 60/BM 76	3973002
6m positioning units for BM 42/BM 48	3976001
6m positioning units for BM 60/BM 76	3976002
Expert controls*	3970100
Attachment for tools of other manufacturers	On request



Patented sliding block

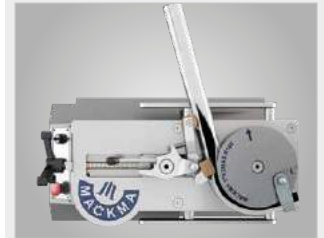

Anti-clockwise bending



Clockwise bending



Lower head bending



Positioning unit



Holding fixtures for third party tools possible

Magnetic drilling
Deburring
Metal grinding
Cutting
Notching & punching
Bending
Presses
Circular saws
Roller conveyors
Metal-cutting band saws

Consultancy by Metallkraft

We are always happy to advise you in case of queries. Our product advisors will support you with technical information. Our customers can use our telephone hotline and our info mail address to request qualified information and solutions.

Contact:

Phone: +49 951 96555-171

email: beratung@metalkraft.de



Commissioning & initial training

When purchasing a Metallkraft machine, we recommend that customers call in one of our specialists to complete commissioning and provide induction training on site.

Commissioning includes:

- Setting up the machine (Unloading and transporting the machine to the installation location; providing the electrical and pneumatic connections, and the floor anchors or assembly plates are the purchaser's responsibility.)
- Cleaning, tooling and aligning
- Checking all functions

Initial training on the machine includes:

- an exhaustive explanation of the controls
- an explanation of the individual functions
- Setting and explaining the basic parameters
- Explaining the safety instructions as per best practices

For programmable models, additionally:

- an exhaustive explanation of the controls
- an explanation of the individual functions
- Setting and explaining the basic parameters
- Explaining the safety instructions as per best practices

Duration of commissioning and initial training:

8 hours per day, including travel times to and from the site, plus travel expenses at €0.69 per km, plus any charges for overnight stays as applicable.

If the initial training time itself has to be 8 hours, the travel time is invoiced at €48 /hour.

This also applies for any different or additional services, which must be ordered separately on site and will be invoiced on individual basis.

If the customer requires and requests installation and connecting of the machine, the customer is obliged to support our technician to the best of customer's ability and to provide the required helpers, tools and equipment at customer's own expense.

Commissioning and initial training for standard machines	Art. no.
Initial training & training for CNC controls	EINWMET
Duration of commissioning and initial training for custom machines*	EINWGBPMET

* DBM, MBBS, FSM, HTBS, MSBM Pro, controlled PRM and MRB, GBP, LMS 400A and metal band saws with X-control

PRM 10 – Manual or motorised ring bending machines, horizontally and vertically deployable for sections, pipes and solid materials

- ▶ For plate rolling of square materials
- ▶ Stable, design suitable for floor anchoring
- ▶ Two bottom rollers driven by crank

- ▶ Rollers tempered and polished
- ▶ Tempered and polished steel shafts
- ▶ Feed via top roller

PRM 10 E

- ▶ Motorised version
- ▶ Horizontal and vertical working positions
- ▶ Powerful 400 volt motor
- ▶ Clockwise/anti-clockwise operation using foot pedal



PRM 10 M

PRM 10 E

Scope of delivery:

- › Standard bending rollers (see table on right)
- › Mobile foot pedal for clockwise/anti-clockwise operation with emergency off function (PRM 10 E)
- › Straightening rollers
- › Chassis

Model	PRM 10 M	PRM 10 E
Art. no.	3780010	3780011
€ plus VAT	1,019.00	2,150.00

Technical specifications

	PRM 10 M	PRM 10 E
Shaft Ø	30 mm	30 mm
Roller Ø at the top	98 mm	98 mm
Roller Ø at the bottom	118 mm	118 mm
Speed	-	2.5 m/min
Motor output	-	1.1 kW
Electrical connection	-	400 V / 50 Hz
Weight	165 kg	230 kg
Dimensions L x W x H	620 x 560 x 1 440 mm	700 x 700 x 1 400 mm

PRM 10 E







Horizontal and vertical working position

Bending performance

PRM 10

Section type	max. size mm	min. bending Ø mm
--------------	--------------	-------------------

Bending options with **standard** bending rollers:







	20 x 20 10 x 10	500 160
	30 x 10 20 x 5	500 190
	50 x 10 40 x 5	400 160
	35 x 4.5 30 x 4	600 400
	35 x 4.5 30 x 4	600 400
	35 x 4.5 30 x 4	600 400
	U40x20 U30	700 500

Bending performance

PRM 10

Section type	max. size mm	min. bending Ø mm
--------------	--------------	-------------------

Bending options with **optional** bending rollers:

	30 x 30 x 2 20 x 20 x 2	900 600
	38 x 20 x 2 30 x 15 x 1.5	1 000 600
	Ø 27 Ø 17	500 160
	Ø 1" x 2 Ø 3/4" x 1.5	800 400
	Ø 33 x 3 Ø 26 x 2.5	700 500
	35 x 35 x 4 30 x 30 x 4	800 400
	35x35x4 30x30x4	800 400

Performance data are based on material with a max. yield strength of 24 kg/mm². Bending performance for stainless steel (VA): factor 0.7 *May require additional spacers

**The "special lateral rollers" option is required in addition to the angle rollers for bending angle steel

Ring bending machine

PRM 31 F – motorised ring bending machine, suitable for horizontal and vertical applications on sections, pipes and solid materials

- ▶ Heavy-duty welded structure made of steel
- ▶ Horizontal and vertical working positions
- ▶ Bottom rollers driven directly by the motor
- ▶ Tempered rollers
- ▶ Shafts made of special steel, hardened and polished
- ▶ Feed via top roller
- ▶ Continuously adjustable, lateral guide rollers
- ▶ Clockwise/anti-clockwise operation using foot pedal
- ▶ Mobile control panel with foot controls

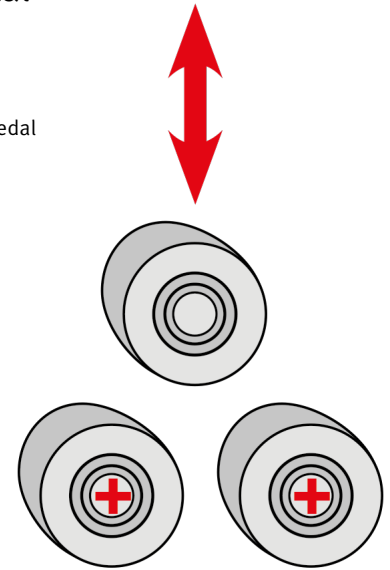

Model	PRM 31 F
Art. no.	3812031







Technical specifications	
Shaft Ø	30 mm
Roller Ø at the top	148 mm
Roller Ø at the bottom	118 mm
Speed	4 m/min
Motor output	0.75 kW
Electrical connection	400 V / 50 Hz
Weight	220 kg
Dimensions L x W x H	600 x 800 x 1 450 mm







Scope of delivery:

- › Standard bending rollers (refer to table on the right for bending options)
- › Mobile foot pedal for clockwise/anti-clockwise operation with emergency off function
- › Straightening rollers
- › Chassis

Custom accessories

- › Digital indicator for adjustment roller
- › Pipe bending rollers
- › Angle bending rollers
- › Special alignment rollers
- › Section bending rollers
- › Plastic rollers for soft materials
- › Equipment to twist rods
- › Spiral bending tool

Bending performance PRM 31 F		
Section type	max.size mm	min.bending Ø mm
Bending option with standard bending rollers:		
	30 x 30 10 x 10	900 200
	50 x 10 20 x 6	800 300
	80 x 15 30 x 6	700 400
	50 x 6* 20 x 3*	600 400
	50 x 6 20 x 3	600 400
	50 x 6 20 x 3	600 400

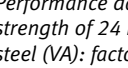
Bending performance PRM 31 F		
Section type	max.size mm	min.bending Ø mm
Bending options with optional bending rollers:		
	40 x 3 30 x 2	1 200 800
	50 x 30 x 3 40 x 20 x 2	1 200 800
	Ø30 Ø10	900 200
	1 1/2" x 2.9 1/4" x 1.8	600 300
	Ø60x1.5 Ø25x1.5	1 000 600
	40 x 40 x 5 30 x 30 x 4	600 300
	35 x 35 x 5 30 x 30 x 4	600 300

Performance data are based on material with a max. yield strength of 24 kg/mm². Bending performance for stainless steel (VA): factor 0.7 *May require additional spacers
**The "special lateral rollers" option is required in addition to the angle rollers for bending angle steel

Accessories	Art. no.
Digital indicator for adjustment roller	3880075
Special guide rollers at the sides, for angle section	3880076
Bending tool to process bars	3880151
Spiral bending tool	3880152
Bending rollers* (please note information below!) (1 set comprises 3 rollers)	
Ø10 mm	388007710
Ø12 mm	388007712
Ø1/4" / 13.5 mm	388007713,5
Ø15.0 mm	388007715,0
Ø16 mm	388007716
Ø17.0 mm	388007717,0
Ø17.2 mm	388007717,2
Ø20.0 mm	388007720,0
Ø21.0 mm	388007721,0
Ø1/2" / 21.3 mm	388007721,3
Ø22.0 mm	388007722,0
Ø25.0 mm	388007725,0
Ø3/4" / 26.9 mm	388007726,9
Ø27.0 mm	388007727,0
Ø28.0 mm	388007728,0
Ø30.0 mm	388007730,0
Ø32.0 mm	388007732,0
Ø33.0 mm	388007733,0
Ø33.4 mm	388007733,4
Ø1" / 33.7 mm	388007733,7
Ø8 mm	38800778
Ø34.0 mm	388007834,0
Ø35.0 mm	388007835,0
Ø38.0 mm	388007838,0
Ø38.7 mm	388007838,7
Ø40.0 mm	388007840,0
Ø41.5 mm	388007841,5
Ø42.0 mm	388007842,0
Ø1 1/4"/42.4 mm	388007842,4
Ø1 1/2"/48.3 mm	388007848,3
Ø49.0 mm	388007849,0
Ø64.0 mm	388007864,0
Custom dimensions	

Accessories	Art. no.
Angle rollers made of steel/iron ***	
30 x 30 x 3 mm	3880080
40 x 40 x 5 mm	3880081
Custom dimensions	
Plastic rollers for aluminium and stainless steel	
Ø12 mm	388008212,0
Ø1/4" / 13.5 mm	388008213,5
Ø16.0 mm	388008216,0
Ø20 mm	388008220,0
Ø1/2" / 21.3 mm	388008221,3
Ø21.7 mm	388008221,7
Ø22 mm	388008222,0
Ø25 mm	388008225,0
Ø3/4" / 26.9 mm	388008226,9
Ø27.1 mm	388008227,1
Ø30 mm	388008230,0
Ø33.0 mm	388008233,0
Ø1" / 33.7 mm	388008233,7
Ø8.0 mm	38800828,0
Ø35 mm	388008335,0
Ø40 mm	388008340,0
Ø1 1/4"/42.0 mm	388008342,0
Ø1 1/4"/42.4 mm	388008342,4
Ø42.7 mm	388008342,7
Ø43.0 mm	388008343,0
Ø1 1/2"/48.3 mm	388008348,3
Ø50 mm	388008450,0
Ø50.8 mm	388008450,8
Ø60.0 mm	388008460,0
Ø60.3 mm	388008460,3
Custom dimensions	
Plastic angle rollers for aluminium and stainless steel***	
30 x 30 x 3 mm	3880085
40 x 40 x 5 mm	3880086
Custom dimensions	

* Price/roller set relates to a dimension from this mm range; state the material dimension you would like to process in your order. Rollers are produced as per these dimensions.

***The "special lateral rollers" option is required in addition to the angle rollers for bending angle steel

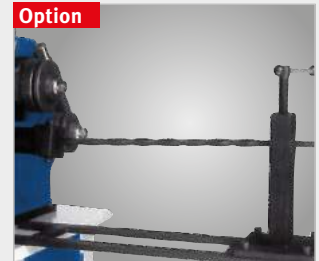

Option
► Optional bending tool to process items including decorative, wrought-iron rods (Fig. similar item)

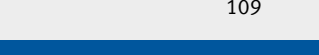
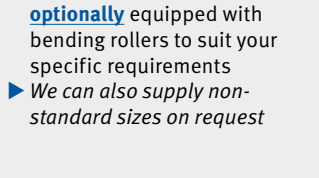
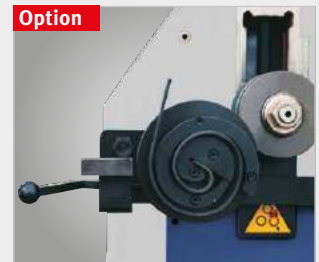

Option

Option

Option

Option

Option

Option

Option

Option: spiral bending application with optional bending tool

Option

Option: special guide rollers on the sides, for angle sections

Please state the material type you would like to process in your order!

Note

► The machine can be optionally equipped with bending rollers to suit your specific requirements
► We can also supply non-standard sizes on request

Magnetic drilling
Deburring
Metal grinding
Cutting
Notching & punching
Bending
Presses
Circular saws
Roller conveyors
Metal-cutting band saws

Ring bending machine

PRM 35 F – motorised ring bending machine, suitable for horizontal and vertical applications on sections, pipes and solid materials

- ▶ Heavy-duty welded structure made of steel
- ▶ Horizontal and vertical working positions
- ▶ Motorised bottom rollers
- ▶ Tempered rollers
- ▶ Tempered and polished steel shafts
- ▶ Feed via top roller
- ▶ Continuously adjustable, lateral guide rollers
- ▶ Clockwise/anti-clockwise operation using foot pedal

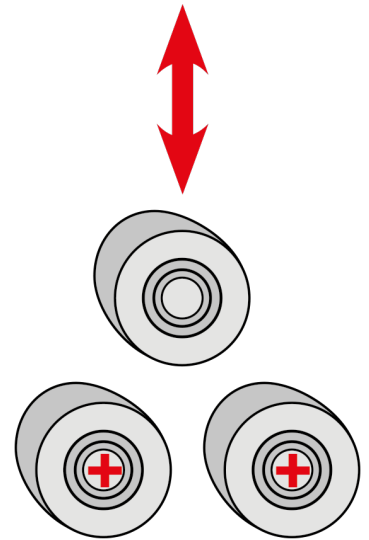

Horizontal and vertical working positions

Model	PRM 35 F
Art. no.	3812035









Technical specifications	
Shaft Ø	50 mm
Roller Ø at the top	155 mm
Roller Ø at the bottom	155 mm
Speed	4.5 m/min
Motor output	1.5 kW
Electrical connection	400 V/50 Hz
Weight	400 kg
Dimensions in mm	750 x 1 000 x 1 400







Scope of delivery:

- > Standard bending rollers (refer to table on the right for bending options)
- > Mobile foot pedal for clockwise/anti-clockwise operation with emergency off function
- > Straightening rollers
- > Chassis

Custom accessories

- > Digital indicator for adjustment roller
- > Pipe bending rollers
- > Angle bending rollers
- > Special alignment rollers
- > Section bending rollers
- > Plastic rollers for soft materials
- > Equipment to twist rods
- > Spiral bending tool

Bending performance PRM 35 F		
Section type	max.size mm	min.bending Ø mm
Bending option with standard bending rollers:		
	35 x 35 20 x 20	900 300
	60 x 10 40 x 10	500 400
	100 x 15 60 x 10	450 350
	60 x 7* 50 x 6*	700 500
	60 x 7 50 x 6	700 500
	60 x 7 50 x 6	700 500
	UPN 80* UPN 30*	1 000 700
	UPN 80* UPN 30*	1 200 800

Bending performance PRM 35 F		
Section type	max.size mm	min.bending Ø mm
Bending options with optional bending rollers:		
	50 x 3 40 x 3	1700 600
	70 x 30 x 2 50 x 40 x 3	1 200 1 200
	Ø35 Ø30	600 400
	2" x 2.9 1" x 2.3	1 000 350
	Ø70 x 2 Ø30 x 2	1 000 500
	50 x 50 x 5 40 x 40 x 5	800 600
	50 x 50 x 6 30 x 30 x 3	1 000 500

Performance data are based on material with a max. yield strength of 24 kg/mm². Bending performance for stainless steel (VA): factor 0.7 *May require additional spacers
*The "special lateral rollers" option is required in addition to the angle rollers for bending angle steel

Accessories	Art. no.
Digital indicator for adjustment roller	3880087
Special guide rollers at the sides, for angle section	3880088
Bending tool to process bars	3880153
Spiral bending tool	3880154

**Bending rollers* (please note information below!)
Steel/iron rollers (1 set comprises 3 rollers)**

Ø10.0 mm	388008910.0
Ø10.2 mm	388008910.2
Ø12.0 mm	388008912.0
Ø12.0 mm	388008913.5
Ø14.0 mm	388008914.0
Ø16.0 mm	388008916.0
Ø17.2 mm	388008917.2
Ø20.0 mm	388008920.0
Ø1/2" / 21.3 mm	388008921.3
Ø28.0 mm	388008922.0
Ø25.0 mm	388008925.0
Ø3/4" / 26.9 mm	388008926.9
Ø27.0 mm	388008927.0
Ø28.0 mm	388008928.0
Ø30.0 mm	388008930.0
Ø32.0 mm	388008932.0
Ø33.0 mm	388008933.0
Ø1" / 33.7 mm	388008933.7
Ø35.0 mm	388008935.0
Ø30.0 mm	388009030.0
Ø34.0 mm	388009034.0
Ø35.0 mm	388009035.0
Ø38.0 mm	388009038.0
Ø40.0 mm	388009040.0
Ø42.0 mm	388009042.0
Ø42.3 mm	388009042.3
Ø1 1/4" / 42.4 mm	388009042.4
Ø42.7	388009042.7
Ø42.8 mm	388009042.8
Ø1 1/2" / 48.3 mm	388009048.3
Ø50.0 mm	388009150.0
Ø 54.0 mm	388009154.0
Ø2" / 60.3 mm	388009160.3
Ø 63.5 mm	388009163.5
Custom dimensions	

Accessories	Art. no.
Angle rollers made of steel/iron ***	
30 x 30 x 3 mm	3880092
40 x 40 x 5 mm	3880093
50 x 50 x 6 mm	3880094
Custom dimensions	

Plastic rollers for aluminium and stainless steel

Ø10.0 mm	388009510.0
Ø12.0 mm	388009512
Ø16.0 mm	388009516.0
Ø20.0 mm	388009520.0
Ø1/2" / 21.3 mm	388009521.3
Ø22.0 mm	388009522.0
Ø25.0 mm	388009525.0
Ø3/4" / 26.9 mm	388009526.9
Ø28.0 mm	388009528.0
Ø30.0 mm	388009530.0
Ø1" / 33.7 mm	388009533.7
Ø33.7 mm	388009633.7
Ø 38.1 mm	388009638.1
Ø40.0 mm	388009640.0
Ø42.0 mm	388009642.0
Ø42.2 mm	388009642.2
Ø1 1/4" / 42.4 mm	388009642.4
Ø42.7 mm	388009642.7
Ø1 1/2" / 48.3 mm	388009648.3
Ø49.0 mm	388009749.0
Ø50.0 mm	388009750.0
Ø60.0 mm	388009760.0
Ø2" / 60.3 mm	388009760.3
Ø70.0 mm	388009770.0
Custom dimensions	

Plastic angle rollers for aluminium and stainless steel***

30 x 30 x 3 mm	3880098
40 x 40 x 5 mm	3880099
50 x 50 x 6 mm	3880100
Custom dimensions	

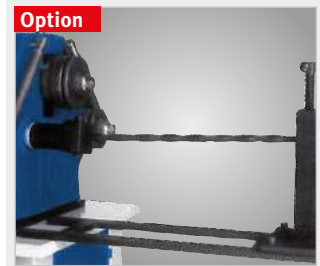

Option
► Optional bending tool to process items including decorative, wrought-iron rods (Fig. similar item)

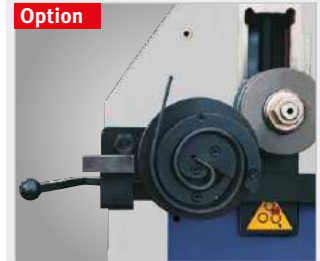

Option
► Spiral bending application with optional bending tool

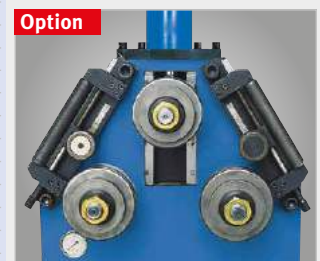

Option
► Option: special guide rollers on the sides, for angle sections



Option
► Application ring bending



Note
► The machine can be optionally equipped with bending rollers to suit your specific requirements
► We can also supply non-standard sizes on request

***The "special lateral rollers" option is required in addition to the angle rollers for bending angle steel

Magnetic drilling
Deburring
Metal grinding
Cutting
Notching & punching
Bending
Presses
Circular saws
Roller conveyors
Metal-cutting band saws

Ring bending machine

PRM 40 FH – ring bending machine, suitable for horizontal and vertical applications on sections and pipes, featuring foot controls

- ▶ Heavy-duty cast design
- ▶ Tempered bending rollers
- ▶ Shafts made of special steel, hardened and polished
- ▶ Continuously adjustable, lateral guide rollers
- ▶ All 3 rollers driven via gear
- ▶ Horizontal and vertical working position
- ▶ Suitable for particularly small bending diameters due to bottom roller with orbital feed
- ▶ Mobile control panel with two digital displays for feed rollers
- ▶ Straightening roller as standard for bending angled steel

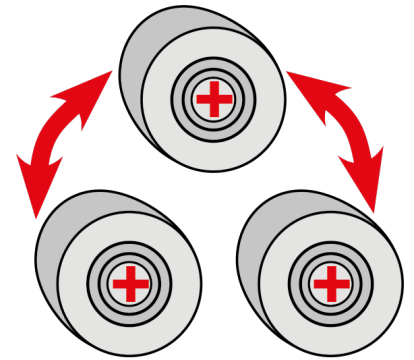







Model	PRM 40 FH
Art. no.	3812040
Technical specifications	
Shaft Ø	35 mm
Roller Ø	137 mm
Speed	7 m/min.
Motor output 400 V / 50 Hz	1.1 kW
Electrical connection	400 V/50 Hz
Weight	350 kg
Dimensions L x W x H	1 050 x 500 x 1 250 mm









Scope of delivery:

- › Standard bending rollers (refer to table on the right for bending options)
- › Digital displays for feed rollers
- › Mobile control panel
- › Straightening rollers
- › Chassis

Custom accessories

- Pipe bending rollers
- › Angle bending rollers
 - › Special alignment rollers
 - › Section bending rollers
 - › Plastic rollers for soft materials
 - › Equipment to twist rods
 - › Spiral bending tool

Bending performance		
PRM 40 FH		
Section type	max. size mm	min. bending Ø mm
Bending option with standard bending rollers:		
	18 x 18	250
	35 x 8	300
	50 x 12	400
	35 x 35 x 5	400
	30 x 30 x 5	300
	35 x 35 x 5	300
	UPN 40 x 20*	350

Bending performance		
PRM 40 FH		
Section type	max. size mm	min. bending Ø mm
	UPN 35 x 18*	500
Bending options with optional bending rollers:		
	25 x 25 x 2	450
	30 x 15 x 2.5	500
	Ø22	200
	Ø33.7x2.3	400 200
	Ø40x1.5	500
	35 x 35 x 5	400
	30 x 30 x 4	550

Performance data are based on material with a max. yield strength of 24 kg/mm². Bending performance for stainless steel (VA): factor 0.7 *May require additional spacers
**The "special lateral rollers" option is required in addition to the angle rollers for bending angle steel



► Option: NC control with touchscreen and teach-in function



► Standard control panel



► Straightening roller adjustment



► Orbital feed of bottom rollers



► Pressure gauge



Note

► The machine can be **optionally** equipped with bending rollers to suit your specific requirements
► We can also supply non-standard sizes on request

Accessories	Art. no.
Angle rollers made of steel/iron	
30 x 30 x 3 mm	3880273
40 x 40 x 5 mm	3880274
50 x 50 x 6 mm	3880275
60 x 60 x 6 mm	3880276
Custom dimensions	
Accessories	Art. no.
Bending rollers steel-iron	
Ø 0- 33.7 mm	3880270
Ø 34- 48.3 mm	3880271
Ø 49- 60.3 mm	3880272
Custom dimensions	

Accessories	Art. no.
Plastic angle rollers for aluminium and stainless steel	
30 x 30 x 3 mm	3880280
40 x 40 x 5 mm	3880281
50 x 50 x 6 mm	3880282
60 x 60 x 6 mm	3880283
Custom dimensions	
Accessories	Art. no.
Plastic rollers for aluminium and stainless steel	
Ø 0- 33.7 mm	3880277
Ø 34- 48.3 mm	3880278
Ø 49- 60.3 mm	3880279
Custom dimensions	

* Price/roller set relates to a dimension from this mm range; state the material dimension you would like to process in your order. Rollers are produced as per these dimensions.

Ring bending machine

PRM 50 FH – hydraulic ring bending machine, suitable for horizontal and vertical applications on sections, pipes and solid materials

- ▶ Heavy-duty welded structure made of steel
- ▶ Horizontal and vertical working positions
- ▶ Hydraulic feed of top roller
- ▶ Digital indicator for adjustment roller
- ▶ All 3 rollers are driven and tempered
- ▶ Continuously adjustable, lateral guide rollers
- ▶ Separate control panel with foot controls



Application ring bending

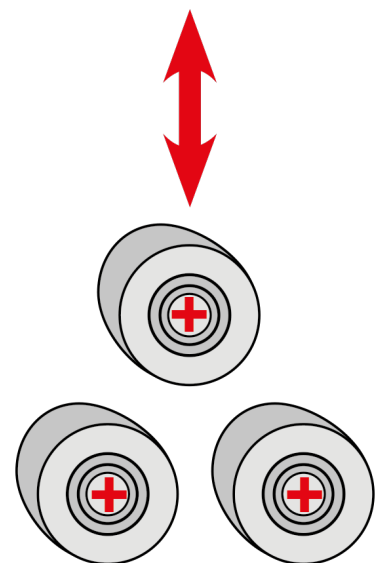







Model	PRM 50 FH
Art. no.	3812036
Technical specifications	
Shaft Ø	50 mm
Roller Ø at the top	162 mm
Roller Ø at the bottom	152 mm
Speed	4.5 m/min.
Hydraulic pressure	8 t
Motor output	1.1 kW
Electrical connection	400 V/50 Hz
Weight	500 kg
Dimensions in mm	810 x 950 x 1 500





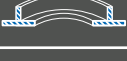

Scope of delivery:

- › Standard bending rollers (refer to table on the right for bending options)
- › Mobile foot pedal for clockwise/anti-clockwise operation with emergency off function
- › Straightening rollers
- › Digital indicator for adjustment roller

Custom accessories

- Pipe bending rollers
- › Angle bending rollers
- › Special alignment rollers
- › Section bending rollers
- › Plastic rollers for soft materials

Bending performance		
Section type	PRM 50 F	
	max.size mm	min.bending Ø mm
Bending option with standard bending rollers:		
	35 15	600 300
	60 x 10 20 x 10	600 300
	100 x 15 50 x 10	600 300
	60 x 7* 30 x 4*	800 500
	60 x 7 30 x 4	800 500
	50 x 6 30 x 4	800 400
	UPN 80* UPN 30*	800 400
	UPN 80* UPN 30*	1200 600

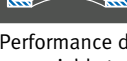
Bending performance		
Section type	PRM 50 F	
	max.size mm	min.bending Ø mm
Bending options with optional bending rollers:		
	50 x 3 20 x 2	1 600 400
	70 x 30 x 3 30 x 15 x 2	1 500 400
	Ø 35 Ø 20	600 300
	Ø 2" x 2.9 Ø 1/2" x 2.3	1 000 300
	Ø 70 x 2 Ø 25 x 1.5	1 200 400
	50 x 6 30 x 3	600 400
	50 x 6 30 x 3	900 600

Performance data are based on material with a max. yield strength of 24 kg/mm². Bending performance for stainless steel (VA): factor 0.7 *May require additional spacers
**The "special lateral rollers" option is required in addition to the angle rollers for bending angle steel



Note

- ▶ The machine can be **optionally** equipped with bending rollers to suit your specific requirements
- ▶ We can also supply non-standard sizes on request

Accessories PRM 50 FH	Art. no.
Special straightening rollers for angled sections	3880102
Bending rollers* for PRM 50 FH (information below!)	
Steel/iron rollers	
Ø 0- 33.7 mm	3880103
Ø 34- 48.3 mm	3880104
Ø 49- 60.3 mm	3880105
Custom dimensions	
Angle rollers made of steel/iron	
30 x 30 x 3 mm	3880106
40 x 40 x 5 mm	3880107
50 x 50 x 6 mm	3880108
60 x 60 x 6 mm	3880109
Custom dimensions	

Accessories PRM 50 FH	Art. no.
Plastic rollers for aluminium and stainless steel*	
Ø 0- 33.7 mm	3880110
Ø 34- 48.3 mm	3880111
Ø 49- 60.3 mm	3880112
Custom dimensions	
Plastic angle rollers for aluminium and stainless steel**	
30 x 30 x 3 mm	3880113
40 x 40 x 5 mm	3880114
50 x 50 x 6 mm	3880115
60 x 60 x 6 mm	3880116
Custom dimensions	

Accessories PRM 50	Art. no.
lateral Angle guide	3880161
NC control**	3880163

Please state the material type you would like to process in your order!



- ▶ Option: NC control with touchscreen and teach-in function



- ▶ Digital position display for feed roller

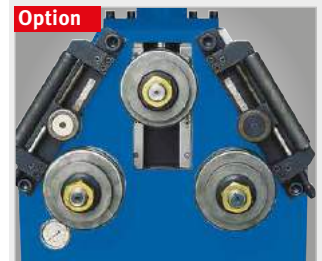

- ▶ Option: special guide rollers on the sides, for angle sections

Ring bending machine

PRM 60 FH – hydraulic ring bending machine, suitable for horizontal and vertical applications on sections, pipes and solid materials

- ▶ Heavy-duty welded structure made of steel
- ▶ Horizontal and vertical working positions
- ▶ Hydraulic feed of top roller
- ▶ Digital indicator for adjustment roller
- ▶ All 3 rollers are driven and tempered
- ▶ Continuously adjustable, lateral guide rollers
- ▶ Separate control panel with foot controls



Application ring bending

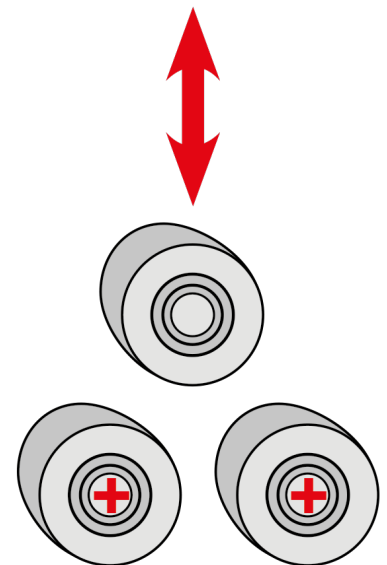







Model	PRM 60 FH
Art. no.	3812060
Technical specifications	
Shaft Ø	60 mm
Roller Ø at the top	215 mm
Roller Ø at the bottom	215 mm
Speed	4 m/min.
Hydraulic pressure	16 t
Motor output	1.5 kW
Electrical connection	400 V/50 Hz
Weight	950 kg
Dimensions in mm	1 000 x 1 400 x 1 650









Scope of delivery:

- › Standard bending rollers (refer to table on the right for bending options)
- › Mobile foot pedal for clockwise/anti-clockwise operation with emergency off function
- › Straightening rollers
- › Digital indicator for adjustment roller

Custom accessories

- › Pipe bending rollers
- › Angle bending rollers
- › Special alignment rollers
- › Section bending rollers
- › Plastic rollers for soft materials

Bending performance		
PRM 60 F		
Section type	max. size mm	min. bending Ø mm
Bending option with standard bending rollers:		
	50 20	800 400
	80 x 20 40 x 10	1 200 400
	120 x 25 50 x 10	600 400
	80 x 9* 40 x 5*	1 000 400
	80 x 9 40 x 5	1 000 400
	80 x 9 40 x 5	1 200 500
	UPN 120* UPN 60*	800 500

Bending performance		
PRM 60 F		
Section type	max. size mm	min. bending Ø mm
	UPN 120* UPN 60*	1 200 600
Bending options with optional bending rollers:		
	70 x 3 40 x 2	1 600 500
	80 x 40 x 3 40 x 20 x 2	1 400 500
	Ø 50 Ø 20	800 400
	Ø 3" x 3.2 Ø 1" x 2.6	1 600 500
	Ø 100 x 2 Ø 60 x 2	1 600 500
	70 x 7 40 x 5	1 000 500
	70 x 7 40 x 5	1 200 600

Performance data are based on material with a max. yield strength of 24 kg/mm². Bending performance for stainless steel (VA): factor 0.7 *We recommend special bending roller sets for optimal bending results **The "special lateral rollers" option is required in addition to the angle rollers for bending angle steel



Note

- ▶ The machine can be **optionally** equipped with bending rollers to suit your specific requirements
- ▶ We can also supply non-standard sizes on request



- ▶ **Option:** NC control with touchscreen and teach-in function



- ▶ **Option:** Digital position display for feed roller

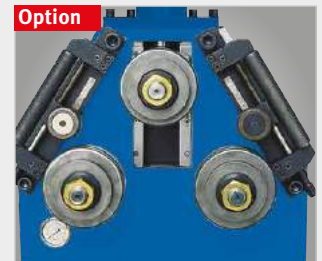

- ▶ **Option:** special guide rollers on the sides, for angle sections

Accessories PRM 60 FH	Art. no.
Special straightening rollers for angled sections	3880161
NC control	3880163
Bending rollers* for PRM 60 FH (please note information below!)	
Steel/iron rollers	
Ø 0- 33.7 mm	3880410
Ø 34- 48.3 mm	3880411
Ø 49- 60.3 mm	3880412
Ø 61 - 76.1 mm	3880413
Ø 77 - 88.9 mm	3880414
Custom dimensions	
Angle rollers made of steel/iron	
50 x 50 x 6 mm	3880420
60 x 60 x 6 mm	3880421
70 x 70 x 6 mm	3880422
Custom dimensions	

Accessories PRM 50 FH	Art. no.
Plastic rollers for aluminium and stainless steel	
Ø 0- 33.7 mm	3880430
Ø 34- 48.3 mm	3880431
Ø 49- 60.3 mm	3880432
Ø 61 - 76.1 mm	3880433
Ø 77 - 88.9 mm	3880434
Custom dimensions	
Plastic angle rollers for aluminium and stainless steel	
50 x 50 x 6 mm	3880440
60 x 60 x 6 mm	3880441
70 x 70 x 6 mm	3880442
Custom dimensions	

Please state the material type you would like to process in your order!

* Price/roller set relates to a dimension from this mm range; state the material dimension you would like to process in your order. Rollers are produced as per these dimensions.

Magnetic drilling
Deburring
Metal grinding
Cutting
Notching & punching
Bending
Presses
Circular saws
Roller conveyors
Metal-cutting band saws

Ring bending machine

PRM 80 FH – hydraulic ring bending machine, suitable for horizontal and vertical applications on sections, pipes and solid materials

- ▶ Heavy-duty welded structure made of steel
- ▶ Horizontal and vertical working positions
- ▶ All three rollers are driven and tempered
- ▶ Hydraulic feed via two bottom rollers
- ▶ Continuously adjustable, lateral guide rollers
- ▶ Separate control panel with 2 digital displays for two feed rollers

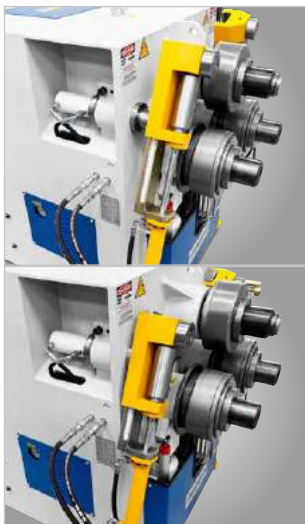
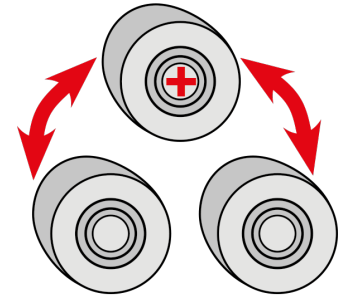

Lateral mechanical straightening rollers, continuously adjustable



PRM 80 FH

Please state the material type you would like to process in your order!









Model	PRM 80 FH
Art. no.	3812080
Technical specifications	
Roller \varnothing	245 mm
Roller holder shaft \varnothing top	80 mm
Roller holder shaft \varnothing bottom	70 mm
Speed	6 m/min.
Motor output	4 kW
Electrical connection	400 V/50 Hz
Weight	1 700 kg
Dimensions in mm	1450 x 1 000 x 1 400

Scope of delivery:







- > Standard bending rollers (refer to table on the right for bending options)
- > Mobile control panel
- > One digital display per bottom feed roller
- > Manual straightening rollers

Custom accessories

- Hydraulic straightening rollers
- > Pipe bending rollers
- > Angle bending rollers
- > Special alignment rollers
- > Section bending rollers
- > Plastic rollers for soft materials
- > NC control

Bending performance PRM 80 FH		
Section type	max.size mm	min.bending Ø mm
Bending option with standard bending rollers:		
	45 15	500 380
	100 x 20 80 x 20 30 x 10	2 000 800 300
	125 x 25 60 x 5	600 300
	80 x 9* 25 x 3.5*	800 280
	70 x 8 25 x 3.5	800 280
	70 x 8 25 x 3.5	800 280
	UPN 140* UPN 120* UPN 100*	1 600 900 600
	UPN 140* UPN 120* UPN 100*	1 600 1 000 800

Bending options with optional bending rollers:

Bending performance PRM 80 FH		
Section type	max.size mm	min.bending Ø mm
	70 x 3 25 x 2	1 300 350
	80 x 25 x 3 25 x 15 x 2	800 350
	Ø 50 Ø 15	500 380
	Ø 3" x 5.48 Ø 1/2" x 2.77	1 200 380
	Ø 100 x 2.5 Ø 15 x 1	800 380
	80 x 8 30 x 3	800 400
	70 x 7 30 x 3	700 450

Performance data are based on material with a max. yield strength of 24 kg/mm². Bending performance for stainless steel (VA): factor 0.7 *We recommend special bending roller sets for optimal bending results **The "special lateral rollers" option is required in addition to the angle rollers for bending angle steel



PRM 80 FH in horizontal working position

Accessories PRM 80 FH	Art. no.
Hydraulic adjustment of the lateral guide rollers	3880170
NC control	3880171

Bending rollers on request



Note

- ▶ The machine can be **optionally** equipped with bending rollers to suit your specific requirements
- ▶ We can also supply non-standard sizes on request



▶ **Option:** NC control with touchscreen and teach-in function

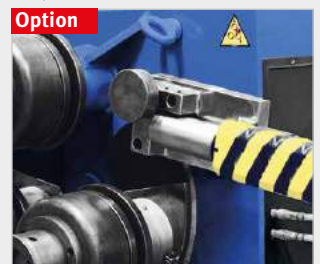

▶ **Option:** two lateral hydraulic guide rollers

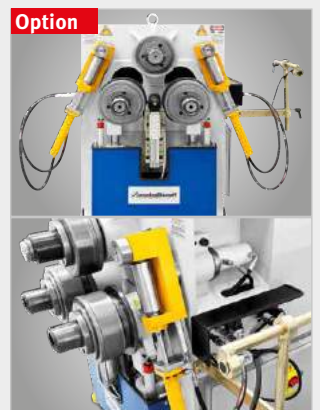

▶ **Option:** hydraulic straightening rollers



▶ **Bending process**



▶ **Bending examples**

Ring bending machine

PRM 100 FH – hydraulic ring bending machine, suitable for horizontal and vertical applications on sections, pipes and solid materials

- ▶ Heavy-duty welded structure made of steel
- ▶ Horizontal and vertical working positions
- ▶ All three rollers are driven by a hydro-motor and planetary gear
- ▶ Tempered rollers
- ▶ Hydraulic feed via two bottom rollers
- ▶ Continuously adjustable, lateral guide rollers
- ▶ Separate control panel with foot controls and 2 digital displays

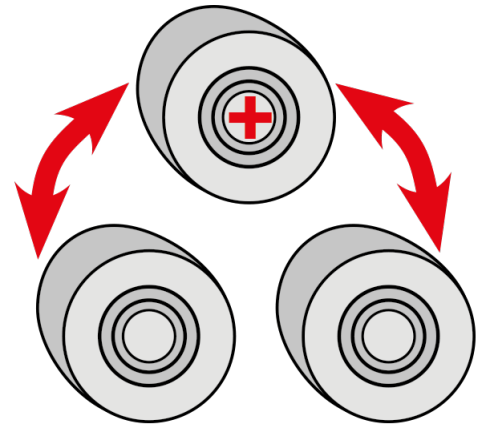

PRM 100 FH

Please state the material type you would like to process in your order!









Model	PRM 100 FH
Art. no.	3812100
€ plus VAT	31.100,00
Technical specifications	
Roller \varnothing	315 mm
Roller holder shaft \varnothing top	100 mm
Roller holder shaft \varnothing bottom	100 mm
Speed	7 m/min.
Motor output	7.5 kW
Electrical connection	400 V/50 Hz
Weight	3 650 kg
Dimensions in mm	2 000 x 1 450 x 1 700







Scope of delivery:

- › Standard bending rollers (refer to table on the right for bending options)
- › Mobile control panel
- › One digital display per bottom feed roller
- › Manual straightening rollers

Custom accessories

- Hydraulic straightening rollers
- › Infinitely adjustable roller speed
- › Pipe bending rollers
- › Angle bending rollers
- › Special alignment rollers
- › Section bending rollers
- › Plastic rollers for soft materials
- › NC control

Bending performance PRM 100 FH		
Section type	max. size mm	min. bending Ø mm
Bending option with standard bending rollers:		
	60 15	750 400
	100 x 20 30 x 10	800 400
	200 x 30 160 x 35 80 x 5	1 200 800 400
	100 x 11 30 x 4	1 000 400
	100 x 11* 30 x 4	1 000 400
	90 x 10 30 x 4	1 000 400
	UPN 180* UPN 30*	900 400
	UPN 180* UPN 30*	1 000 400

Bending performance PRM 100 FH		
Section type	max. size mm	min. bending Ø mm
Bending options with optional bending rollers:		
	80 x 5 25 x 2	1 500 450
	1 000 x 40 x 4 25 x 15 x 2	1 300 400
	Ø 75 Ø 15	800 450
	Ø 4" x 6.02 Ø 1/2" x 2.77	1 000 450
	Ø 125 x 2.5 Ø 15 x 1	1 400 450
	100 x 12 40 x 4	1 000 700
	100 x 10 40 x 4	1 000 550

Performance data are based on material with a max. yield strength of 24 kg/mm². Bending performance for stainless steel (VA): factor 0.7 *We recommend special bending roller sets for optimal bending results **The "special lateral rollers" option is required in addition to the angle rollers for bending angle steel



PRM 100 FH in horizontal working position

Large machines on request

Accessories PRM 100 FH	Art. no.
Hydraulic adjustment of the lateral guide rollers	3880180
NC control	3880181
Continuously variable speed	3880182

Bending rollers on request



Note

- ▶ The machine can be **optionally** equipped with bending rollers to suit your specific requirements
- ▶ We can also supply non-standard sizes on request



▶ Option: NC control with touchscreen and teach-in function

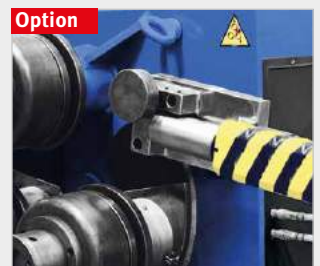

▶ Option: two lateral hydraulic guide rollers

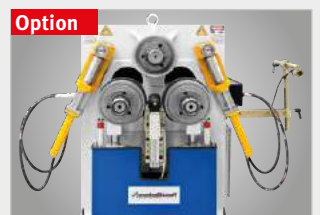

▶ Option: hydraulic straightening rollers



▶ Bending process



▶ Bending example



Sales promotion for Metalkraft end-of-line models, used machines and machines with minor blemishes

Check out our special offer platform for **end-of-line models, machines with transport damage, seconds, one-offs, demonstrators and sample machines** from our product range.

The machines and accessories offered here have been **checked and serviced by our service workshop.**

Articles can be reserved via a user-friendly form.

View and reserve special offer articles at attractive prices online at any time!

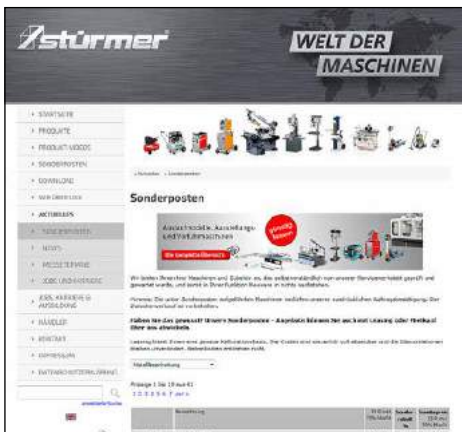

Look here for the Metalkraft special offer platform:
www.stuermer-maschinen.de/aktuelles/sonderposten

SBM – Manual swage bending machines

- ▶ Heavy-duty and rugged cast iron design
- ▶ Adjustable bottom shafts
- ▶ Continuously adjustable stop plate

- SBM 110-08:**
- ▶ 7-part standard roller set
- SBM 140-12:**
- ▶ 8-part standard roller set

Please state the material type you would like to process in your order!



SBM 110-08



SBM 140-12

Bending rollers type E3

Model	SBM 110-08	SBM 140-12
Art. no.	3814001	3814002

Technical specifications	SBM 110-08	SBM 140-12
Roller length	110 mm	140 mm
Max. sheet thickness*	0.80 mm	1.2 mm
Roller Ø	52 mm	62 mm
Collar width	80 mm	100 mm
Weight	30 kg	50 kg
Dimensions L x W x H	380 x 180 x 380 mm	560 x 220 x 500 mm

*Performance data for material with tensile strength of 400 N/mm²

Standard rollers for SBM 110-08 (included in scope of delivery)

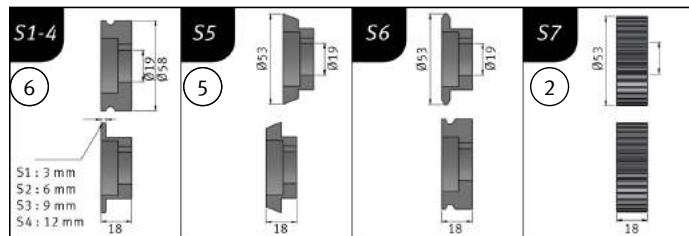

Standard rollers for SBM 140-12 (included in scope of delivery)

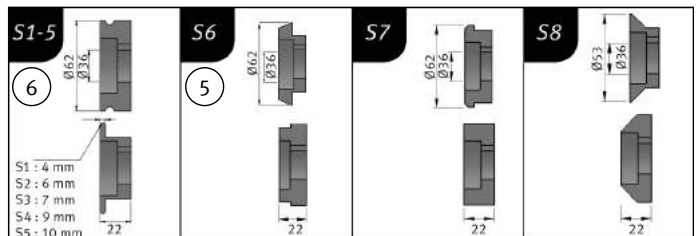

Accessory rollers for SBM 110-08

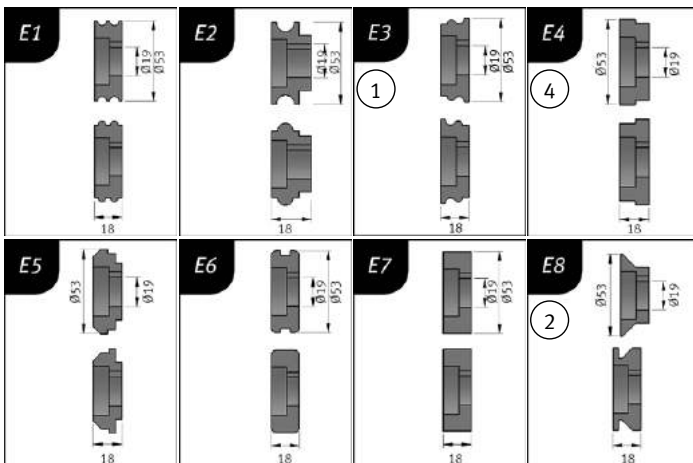

Accessory rollers for SBM 140-12

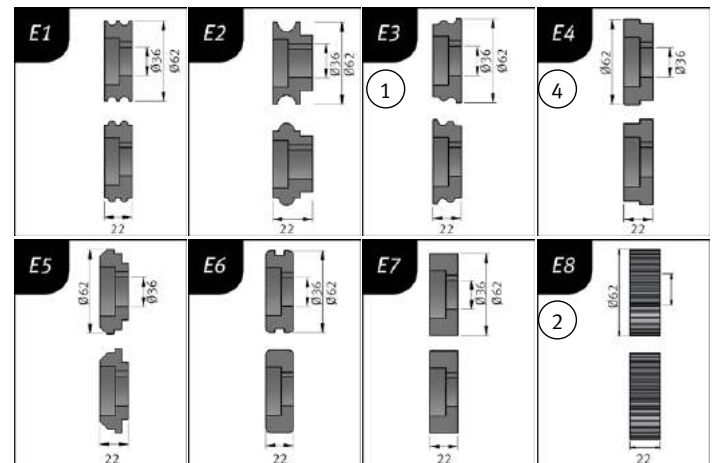

Accessories SBM 110	Art. no.	Accessories SBM 110	Art. no.	Accessories SBM 140	Art. no.	Accessories SBM 140	Art. no.
Bending rollers type E1	3880121	Bending rollers type E5	3880125	Bending rollers type E1	3880131	Bending rollers type E5	3880135
Bending rollers type E2	3880122	Bending rollers type E6	3880126	Bending rollers type E2	3880132	Bending rollers type E6	3880136
Bending rollers type E3	3880123	Bending rollers type E7	3880127	Bending rollers type E3	3880133	Bending rollers type E7	3880137
Bending rollers type E4	3880124	Bending rollers type E8	3880128	Bending rollers type E4	3880134	Bending rollers type E8	3880138

Typical applications

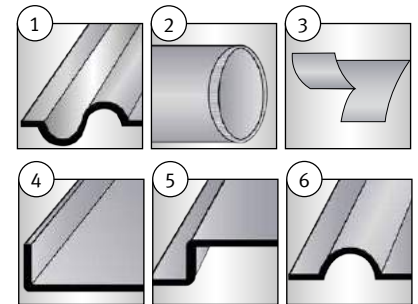

Bead bending machines

SBM 140-12 E – Motorised swage bending machine

- ▶ Heavy-duty and rugged cast iron design
- ▶ Gear motor with brake system
- ▶ Foot pedal operation
- ▶ Adjustable bottom shaft
- ▶ steel shafts
- ▶ With chassis
- ▶ Continuously adjustable stop plate
- ▶ 8-part standard roller set

Please state the material type you would like to process in your order!



SBM 140-12 E

Typical applications

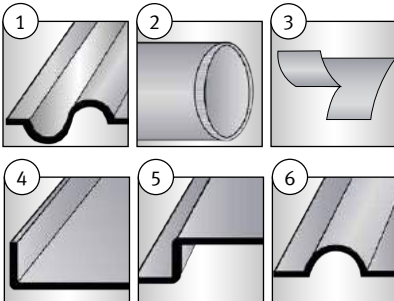

Model	SBM 140-12 E
Art. no.	3814003

Technical specifications	
Roller length	140 mm
Max. sheet thickness*	1.2 mm
Roller Ø	62 mm
Collar width	100 mm
Roller speed	32 rpm
Motor output	0.75 kW
Electrical connection	400 V/50 Hz
Weight	110 kg
Dimensions L x W x H	900 x 1 350 x 450

*Performance data for material with tensile strength of 400 N/mm²

Accessories SBM 140	Art. no.
Bending rollers type E1	3880131
Bending rollers type E2	3880132
Bending rollers type E3	3880133
Bending rollers type E4	3880134
Bending rollers type E5	3880135
Bending rollers type E6	3880136
Bending rollers type E7	3880137
Bending rollers type E8	3880138

Standard rollers for SBM 140-12 E (included in scope of delivery)

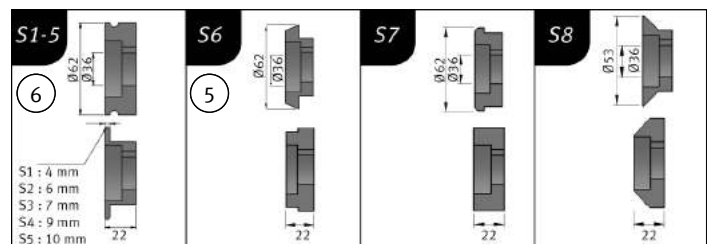

Accessory rollers for SBM 140-12 E

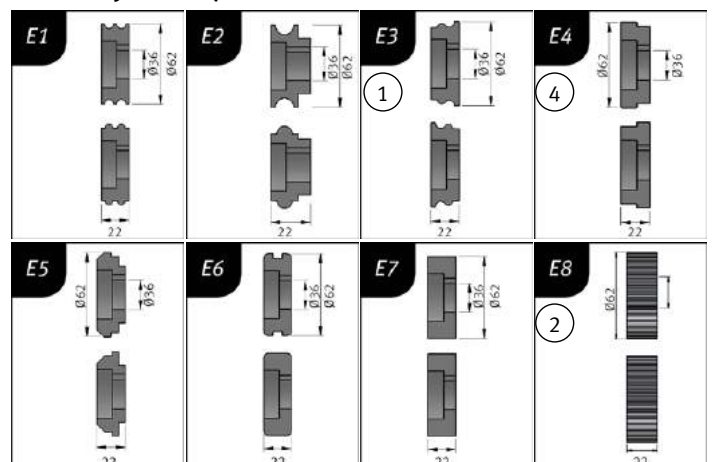

SBM E – Motorised swage bending machines

- ▶ Heavy-duty and stable steel design
- ▶ Self-braking motor
- ▶ Foot pedal operation

- ▶ Adjustable bottom shaft
- ▶ Adjustable stop plate
- ▶ Stahl shafts with bronze bushings fitted

- ▶ 4 set standard rollers
- ▶ Chassis



SBM 250-25 E



SBM 300-40 E

Model	SBM 250-25 E	SBM 300-40 E
Art. no.	3814004	3814005
Technical specifications		
Roller length	250 mm	300 mm
Max. sheet thickness*	2.5 mm	4 mm
Roller Ø	96 mm	126 mm
Collar width	160 mm	200 mm
Roller speed	5 m/min.	5 m/min.
Motor output	1.5 kW	2.2 kW
Electrical connection	400 V/50 Hz	400 V/50 Hz
Weight	350 kg	500 kg
Dimensions L x W x H in mm	1 400 x 550 x 1120	1 700 x 570 x 1 200

*Performance data for material with tensile strength of 400 N/mm²

Please state the material type you would like to process in your order!

Typical applications

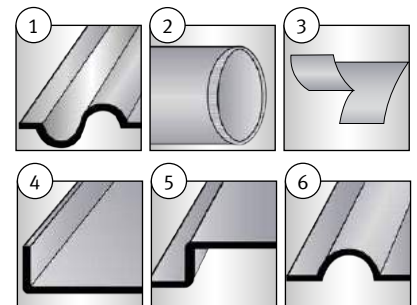

Standard rollers for SBM 250-25 E (incl. in scope of delivery)

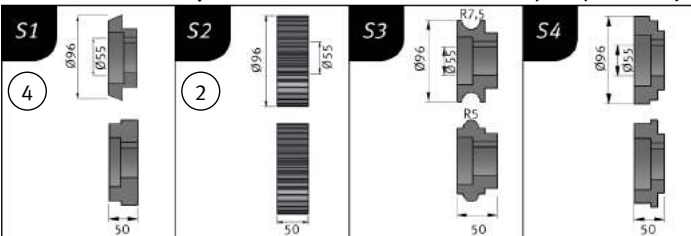

Standard rollers for SBM 300-40 E (incl. in scope of delivery)

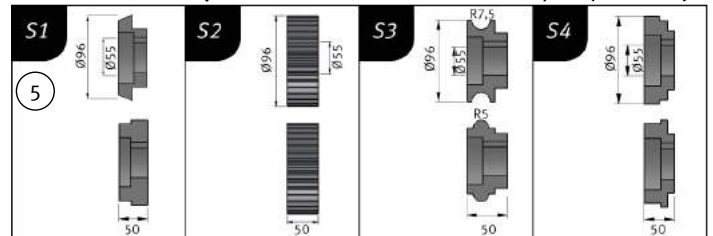

Accessory rollers for SBM 250-25 E

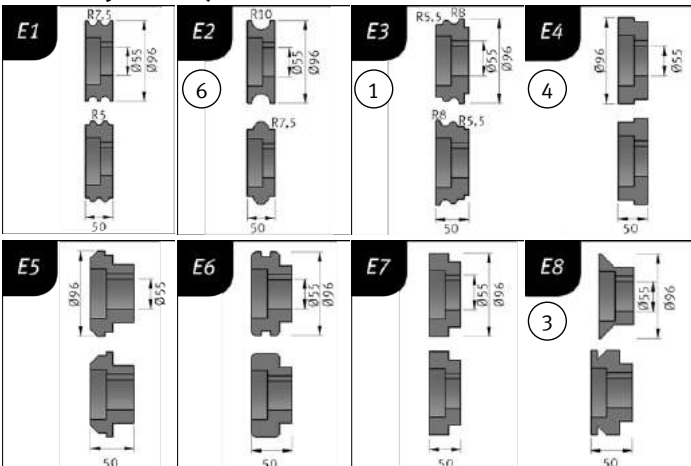

Accessory rollers for SBM 300-40 E

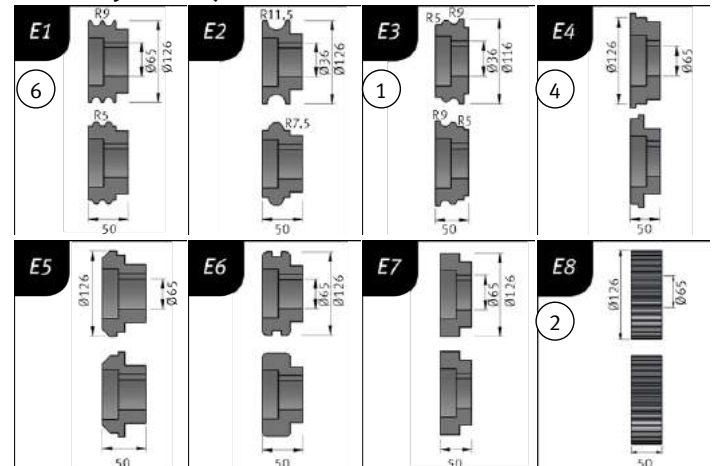

Accessories	Art. no.	Accessories	Art. no.
SBM 250-25E			
Bending rollers type E1	3880711	Bending rollers type E6	3880716
Bending rollers type E2	3880712	Bending rollers type E7	3880717
Bending rollers type E3	3880713	Bending rollers type E8	3880718
Bending rollers type E4	3880714	Surcharge hydraulic top roller*	3880719
Bending rollers type E5	3880715		

Accessories	Art. no.	Accessories	Art. no.
SBM 300-40E			
Bending rollers type E1	3880721	Bending rollers type E6	3880726
Bending rollers type E2	3880722	Bending rollers type E7	3880727
Bending rollers type E3	3880723	Bending rollers type E8	3880728
Bending rollers type E4	3880724	Surcharge hydraulic top roller*	3880729
Bending rollers type E5	3880725		

Manual plate rolling machines

RBM – Manual, asymmetric 3-roller plate rolling machines

- ▶ Steel rollers
- ▶ Top roller folds out for easier removal of the workpiece
- ▶ Asymmetric roller arrangement for convenient pre-bending
- ▶ Skewing side roller for conical bending
- ▶ Clamping and side roller with wire insert grooves
- ▶ Roller drive via crank and gear
- ▶ Particularly handy and thus suitable for working in cramped conditions
- ▶ Perfectly suited for fine work due to lean shaft thickness
- ▶ 3-roller plate rolling machine for all round parts such as pipes, cylinders, etc.
- ▶ Simple and rugged design



RBM 305 with optional Chassis (Art. no. 3780113)



RBM 610-08



▶ Lubrication via lubricating nipple possible (RBM 305)



▶ The upper roller can be swivelled out for easier removal of the finished workpiece

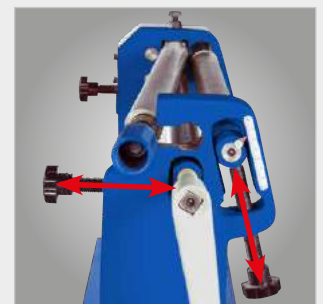

▶ Rear rollers individually adjustable, thus supports conical work
▶ Settings through convenient, generously dimensioned roller adjustment screws

Model	RBM 305	RBM 610-08
Art. no.	3780112	3780618
Technical specifications		
Max. working width	305 mm	610 mm
Max. sheet thickness	0.80 mm	0.80 mm
Roller Ø	25 mm	38 mm
Bending Ø min.	40 mm	60 mm
Wire insert groove Ø	4 / 6 / 8 mm	4.8 / 6.4 / 8 mm
Weight	14 kg	37 kg
Dimensions L x W x H	580 x 210 x 255 mm	885 x 220 x 340 mm

*Performance data for material with tensile strength of 400 N/mm²

Accessories SBM 300-40E
Chassis

Art. no.
3780113

RBM – Manual, asymmetric 3-roller plate rolling machines

- ▶ Heavy-duty and rugged cast iron design
- ▶ Asymmetric 3-roller system for convenient pre-bending
- ▶ Top roller swivels out
- ▶ Roller driven via crank
- ▶ Suitable for bending wires with diameters of 3, 5 and 8 mm
- ▶ Fast clamping of the sheet via a lever



RBM - manually driven plate rolling machines

Technical specifications	Bending width	Max. sheet thickness*	Roller Ø	Bending Ø min.	Weight	Dimensions L x W x H	Art. no.
RBM 1000-20 Eco	1 000 mm	2.0 mm	60 mm	100 mm	200 kg	1542 x 550 x 1040	3781301
RBM 1050-10	1 050 mm	1.0 mm	56 mm	84 mm	185 kg	1 400 x 700 x 1 120	3813101
RBM 1050-22	1 050 mm	2.0 mm	75 mm	115 mm	300 kg	1 400 x 700 x 1 160	3813103
RBM 1550-10	1 550 mm	1.0 mm	68 mm	102 mm	350 kg	2 430 x 700 x 1 160	3813104

*Performance data for material with tensile strength of 400 N/mm²; conical bending performance = factor 0.5; bending performance aluminium = 1.2; bending performance stainless steel (VA) = factor 0.75; the optional tempered rollers are necessary for bending stainless steel (VA)

Please state the material type you would like to process in your order!

Accessories	Art. no.
Tempered rollers RBM 1050-10***	3880071
Tempered rollers RBM 1050-22***	3880073
Tempered rollers RBM 1550-10***	3880074

***Ex works

Manual plate rolling machines

New

RBM 1305-15 E – motorised, asymmetric 3-roller plate rolling machines

- ▶ For creating all round formed parts such as pipes, cylinders, etc.
- ▶ Roller driven via hand crank, or motorised for E models
- ▶ Heavy-duty and rugged cast iron design
- ▶ Asymmetric 3-roller system for convenient pre-bending
- ▶ The upper roller can be swivelled out for easier removal of the finished workpiece
- ▶ Top roller swivels out
- ▶ Easily adjustable top and bottom rollers
- ▶ Taper bending option
- ▶ With safety devices
- ▶ Wire insert groove on bottom and rear roller as standard
- ▶ Foot operation means that both hands are free for feeding in the material

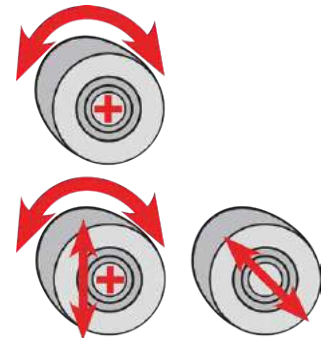

RBM 1305-15 E

Please state the material type you would like to process in your order!

Model	New RBM 1305-15 E
Art. no.	3781305
Technical specifications	
Rolling length	1 270 mm
Sheet thickness*	1.5 mm
Roller Ø	75 mm
Bending Ø min.	110 mm
Motor output	0.75 kW/400 V
Weight	318 kg
Dimensions LxWxH in mm	1 650 x 1 020 x 1 110

*Performance data for material with tensile strength of 400 N/mm²; conical bending performance = factor 0.5; bending performance aluminium = 1.2; bending performance stainless steel (VA) = factor 0.75; the optional tempered rollers are necessary for bending stainless steel (VA) ** Please turn over for descriptions of the packaging surcharges;

RBM E – motorised, asymmetric 3-roller plate rolling machines

- ▶ Heavy-duty and rugged cast iron design
- ▶ Asymmetric 3-roller system for convenient pre-bending
- ▶ Top roller swivels out
- ▶ Taper bending option
- ▶ Safety device emergency stop bar or emergency stop rip cord
- ▶ Wire insert groove in clamping and side roller as standard
- ▶ The upper roller can be swivelled out for easier removal of the finished workpiece
- ▶ Side roller feed with hand wheel
- ▶ Convenient clamping via lever
- ▶ User-friendly
- ▶ Optionally with tempered rollers

Accessories



- ▶ Control console with digital display and motorised side roller feed



RBM 1270-25E

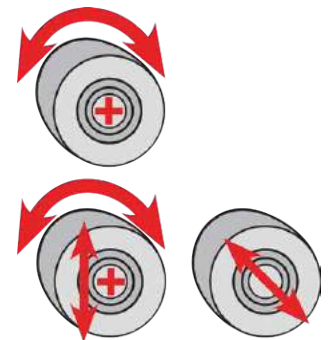

RBM E - motorised plate rolling machine

Model	RBM 1050-30E	RBM 1270-25E	RBM 1550-20E	RBM 2050-15E
Art. no.	3813201	3813202	3813203	3813204
Technical specifications				
Bending Ø min.	135 mm	135 mm	135 mm	145 mm
Bending width	1 050 mm	1 270 mm	1550 mm	2 050 mm
Max. sheet thickness*	3.0 mm	2.5 mm	2.0 mm	1.5 mm
Roller Ø	90 mm	90 mm	90 mm	95 mm
Motor output	1.1 kW	1.1 kW	1.5 kW	1.5 kW
Electrical connection	400 V/50 Hz	400 V/50 Hz	400 V/50 Hz	400 V/50 Hz
Dimensions L x W x H	1 630 x 700 x 1 200	1 850 x 700 x 1 200	2 130 x 700 x 1 200	2 630 x 700 x 1 200
Weight	480 kg	520 kg	580 kg	665 kg

*Performance data for material with tensile strength of 400 N/mm²; conical bending performance = factor 0.5; bending performance aluminium = 1.2; bending performance stainless steel (VA) = factor 0.75; the optional tempered rollers are necessary for bending stainless steel (VA) ** Please turn over for descriptions of the packaging surcharges;

Note	Accessories RBM 1050-30E	Art. no.	Accessories RBM 1550-20E	Art. no.
Machine cannot be retrofitted with accessories, only with orders for new machines	Tempered rollers	3880059	Tempered rollers	3880065
	motorised side roller feed	3880060	motorised side roller feed	3880066
	Digital display for side roller	3880061	Digital display for side roller	3880067
	Accessories RBM 1270-25E	Art. no.	Accessories RBM 2050-15E	Art. no.
	Tempered rollers	3880062	Tempered rollers	3880068
	motorised side roller feed	3880063	motorised side roller feed	3880069
	Digital display for side roller	3880064	Digital display for side roller	3880070

Plate rolling machines

RBM E PRO – Motorised plate rolling machines, heavy-duty type for sheet thicknesses up to 4 mm

- ▶ Heavy-duty welded steel construction
- ▶ Driven top and clamping rollers
- ▶ Top roller swivels out
- ▶ Manual feed of clamping and side roller
- ▶ Roller drive via powerful electric motor and gear
- ▶ Wire grooves on the clamping roller
- ▶ Safety device emergency stop rip cord
- ▶ Mobile control panel and foot pedal

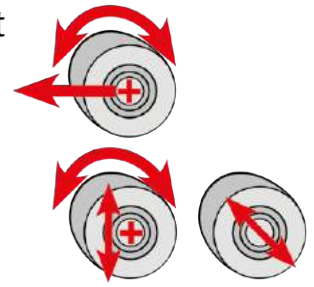

RBM 2050-30 E PRO

Figure shows machine with options digital display for side roller and motorised side roller feed



▶ Top roller swivels out

▶ Control console with digital display, motorised side roller feed and button for material feed instead of foot pedal (option)

Please state the material type you would like to process in your order!

RBM E Pro - motorised plate rolling machines

Model	RBM 1270-40 E Pro	RBM 1550-40 E Pro	RBM 2050-30 E Pro
Art. no.	3813301	3813302	3813303
Technical specifications			
Bending width	1 270 mm	1 550 mm	2 050 mm
Max. sheet thickness*	4 mm	4 mm	3 mm
Roller Ø	120 mm	140 mm	130 mm
Bending Ø min.	180 mm	210 mm	195 mm
Speed	3 m/min.	3.5 m/min.	3.5 m/min.
Motor output	2.2 kW	2.2 kW	2.2 kW
Electrical connection	400 V / 50 Hz	400 V / 50 Hz	400 V / 50 Hz
Weight	1 115 kg	1 350 kg	1 500 kg
Dimensions L x W x H	2 470 x 750 x 1 000 mm	2 470 x 750 x 1 000 mm	3 200 x 750 x 1 000 mm

*Performance data for material with tensile strength of 400 N/mm²; conical bending performance = factor 0.5; bending performance aluminium = 1.2; bending performance stainless steel (VA) = factor 0.75; the optional tempered rollers are necessary for bending stainless steel (VA) ** Please turn over for descriptions of the packaging surcharges

More models on request!

Accessories RBM 1270-40E Pro	Art. no.
Tempered rollers for stainless steel*	3880050
motorised side roller feed	3880051
Digital display for side roller	3880052
Accessories RBM 1550-40E Pro	Art. no.
Tempered rollers for stainless steel*	3880053
motorised side roller feed	3880054
Digital display for side roller	3880055

Accessories RBM 2050-30E Pro	Art. no.
Tempered rollers for stainless steel*	3880056
motorised side roller feed	3880057
Digital display for side roller	3880058

Note
Machine cannot be retrofitted with accessories, only with orders for new machines

RBM E PRO – Motorised round bending machines, heavy-duty type with motorised feed for sheet thicknesses up to 6 mm

- ▶ Heavy-duty welded steel construction
- ▶ Driven top and clamping rollers
- ▶ Motorised side roller feed
- ▶ Top roller swivels out
- ▶ Roller drive via powerful electric motor and gear
- ▶ Safety device emergency stop rip cord
- ▶ Mobile control panel

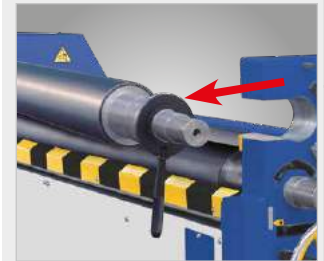
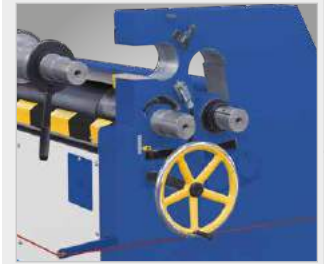
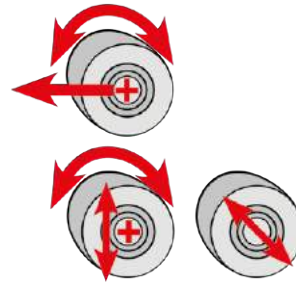

▶ Top roller swivels out



RBM 2050-50E Pro

Fig. shows control console with digital display for side roller feed and motorised clamping roller feed (option)

Please state the material type you would like to process in your order!

Model	RBM 1550-60E Pro	RBM 2050-50E Pro	RBM 2050-60E Pro	RBM 2550-40E Pro	RBM 2550-60E Pro	RBM 3050-60E Pro
Art. no.	3813314	3813315	3813316	3813317	3813318	3813319
Technical specifications						
Bending width	1 550 mm	2 050 mm	2 050 mm	2 550 mm	2 550 mm	3 050 mm
Max. pre-bending performance*	5 mm	4 mm	5 mm	3 mm	5 mm	5 mm
Bending performance max.*	6 mm	5 mm	6 mm	4 mm	6 mm	6 mm
Roller Ø	130 mm	150 mm	170 mm	150 mm	190 mm	220 mm
Roller speed	3.2 m/min.	3.4 m/min.	3.8 m/min.	3.4 m/min.	4.3 m/min.	5.0 m/min.
Bending Ø min.	195 mm	225 mm	255 mm	225 mm	285 mm	330 mm
Motor output	2.2 kW	3.0 kW	4.0 kW	3.0 kW	4.0 kW	5.5 kW
Electrical connection	400 V / 50 Hz	400 V / 50 Hz	400 V / 50 Hz	400 V / 50 Hz	400 V / 50 Hz	400 V / 50 Hz
Weight	1 400 kg	1 885 kg	2 100 kg	2 150 kg	3 400 kg	6 000 kg
Dimensions L x W x H	3250 x 650 x 1020	3750 x 680 x 1040	3850 x 720 x 1 050	4250 x 650 x 1020	4700 x 950 x 1300	5200 x 1150 x 1400

*Performance data for material with tensile strength of 400 N/mm²; conical bending performance = factor 0.5; bending performance aluminium = 1.2; bending performance stainless steel (VA) = factor 0.75; the optional tempered rollers are necessary for bending stainless steel (VA) ** Please turn over for descriptions of the packaging surcharges

Accessories RBM 1550-60E Pro	Art. no.	Accessories RBM 2550-40E Pro	Art. no.	Note
Digital display for side roller	3880220	Digital display for side roller	3880220	Machine cannot be retrofitted with accessories, only with orders for new machines
Motorised clamping roller feed	3880221	Motorised clamping roller feed	3880221	
Tempered rollers for stainless steel	3880225	Tempered rollers for stainless steel	3880234	

Accessories RBM 2050-50E Pro	Art. no.	Accessories RBM 2550-60E Pro	Art. no.
Digital display for side roller	3880220	Digital display for side roller	3880220
Motorised clamping roller feed	3880221	Motorised clamping roller feed	3880221
Tempered rollers for stainless steel	3880228	Tempered rollers for stainless steel	3880237

Accessories RBM 2050-60E Pro	Art. no.	Accessories RBM 3050-60E Pro	Art. no.
Digital display for side roller	3880220	Digital display for side roller	3880220
Motorised clamping roller feed	3880221	Motorised clamping roller feed	3880221
Tempered rollers for stainless steel	3880231	Tempered rollers for stainless steel	3880240

More models on request!

Hydraulic plate rolling machines

RBM 4 HMS PRO – Hydraulic 4-roller plate rolling machines

- ▶ Heavy-duty and durable welded designed
- ▶ Linear feed of clamping and side rollers by hydraulic cylinders
- ▶ Induction tempered rollers, suitable for bending stainless steel
- ▶ Top roller driven by hydro-motor and planetary gear; the motion is transferred to the clamping roller by means of drive shafts
- ▶ Machine protected against overload
- ▶ Three digital displays

- (2 x side rollers, 1 x clamping roller)
- ▶ Hydraulic safety chuck for easy removal of finished workpieces
- ▶ Mobile control panel
- ▶ Conical bending device
- ▶ Hydraulic balancing system to ensure parallelism
- ▶ Safety emergency stop rip cord

Optional accessories:

- ▶ Teach-in NC control
- ▶ Mechanical aux. crane
- ▶ Hydraulic side supports
- ▶ Continuously variable bending speed adjustment

Please state the material type you would like to process in your order!



RBM 1550-110 4 HMS PRO

RBM 4 HMS PRO – Hydraulic 4-roller plate rolling machines

RBM 4 HMS PRO	Working width mm	Pre-bending performance* mm	Bending performance* mm	Ø Top roller mm	Smallest bending Ø* mm	Motor output kW	Bending speed m/min	Length mm	Width mm	height mm	Weight kg	Art. no.
1550-65	1 550	3.5/4.5	4.5/6.5	150	225/750	2.2 & 1.5	6	3 300	1 150	1 110	2 370	3813346
1 550-110	1 550	7/9	9/11	200	300/1 000	4.0 & 1.5	6	3 350	1 350	1 290	3 250	3813347
1550-150	1 550	10/12	12/15	250	375/1250	7.5 & 1.5	5	3 500	1 500	1 370	4 650	3813348
2 050-60	2 050	3/4	4/6	150	225/750	2.2 & 1.5	6	3 800	1 150	1 110	2800	3813349
2050-80	2 050	4/6	6/8	180	270/900	3.0 & 1.5	5	3 850	1 350	1 290	3 300	3813350
2050-100	2 050	6/8	8/10	200	300/1 000	4.0 & 1.5	6	3 850	1 350	1 290	3 750	3813351
2 050-120	2 050	8/10	10/12	250	375/1250	7.5 & 1.5	5	4 000	1 500	1 370	5 350	3813352
2 050-220	2 050	15/18	18/22	300	450/1 500	11	1.5/5	4 400	1 800	1 950	6 500	3813353
2550-60	2 550	3/4	4/6	180	270/900	3.0 & 1.5	5	4 350	1 350	1 290	3 700	3813354
2 550-80	2 550	4/6	6/8	200	300/1 000	4.0 & 1.5	6	4 350	1 350	1 290	4 250	3813355
2 550-100	2 550	6/8	8/10	250	375/1250	7.5 & 1.5	5	4 500	1 500	1 370	6 100	3813356
2 550-180	2 550	12/15	15/18	300	450/1 500	11	1.5/5	4 900	1 800	1 950	7 500	3813357
3050-60	3 050	3/4	4/6	200	300/1 000	4.0 & 1.5	6	4 850	1 350	1 290	4 750	3813358
3 050-90	3 050	5/7	7/9	250	375/1250	7.5 & 1.5	5	5 000	1 500	1 370	6 800	3813359
3050-150	3 050	10/12	12/15	300	450/1 500	11	1.5/5	5 400	1 800	1 950	8 500	3813360
4 050-80	4 050	4/6	6/8	275	410/1375	11	1.5/5	6 400	1 600	1 800	9 000	3813361

*Performance data for material with tensile strength of 400 N/mm² at 1.5 x top roller Ø, 5 x top roller Ø; conical bending performance = factor 0.5; bending performance aluminium = 1.2; bending performance stainless steel (VA) = factor 0.75. ** Please turn over for descriptions of the packaging surcharges;

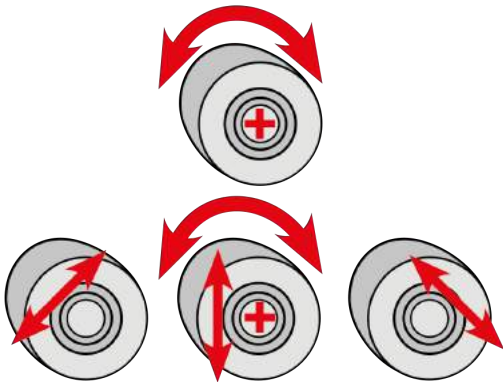

Optional accessories:
▶ Teach-in NC control



Magnetic drilling



Deburring



Metal grinding

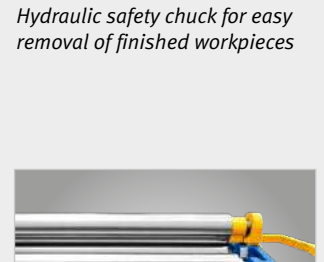

Cutting

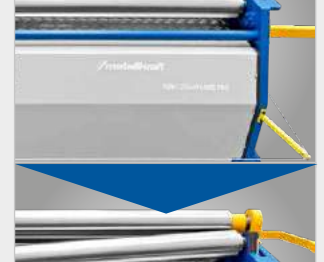

Notching & punching



Conical bending device



Bending

Presses

Circular saws

Roller conveyors



Safety emergency stop rip cord

Metal-cutting band saws

More models and accessories on request

Can we help you?

Your local specialist retailer is more than happy to help you with any issues. We will also be more than happy to support you and provide you with a list of specialist retailers where you are;
contact: +49(0)951 96555-0
beratung@metalkraft.de

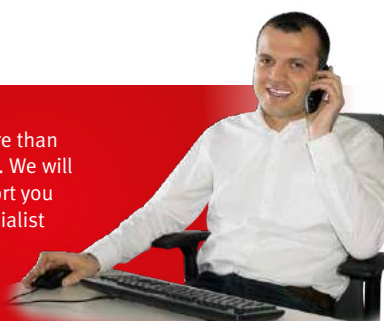

Combined bending and cutting machine/manual brake bending machines

SRWS 1020 KOMBI – Combined machine for roofers for plate rolling, brake bending, cutting and beading

- ▶ 4 machines in 1: Beading machine, plate rolling machine, brake bending machine and roller shears
- ▶ Ideal for roofers on site, e.g. for creating bay window panelling, flashings, chimney cladding or gutters
- ▶ Sturdy and rugged design
- ▶ The removable roller shears allow for precise cutting of copper and zinc sheet with a thickness of up to 0.8 mm
- ▶ Plate rolling function with roller drive via crank and gear
- ▶ With swivel-out top roller
- ▶ With beading function for sheet metals up to 0.6 mm
- ▶ Brake bending function with safe clamping of the workpiece due to spring preload of the top beam

For creating bay window panelling, flashings, chimney cladding or gutters with a single machine

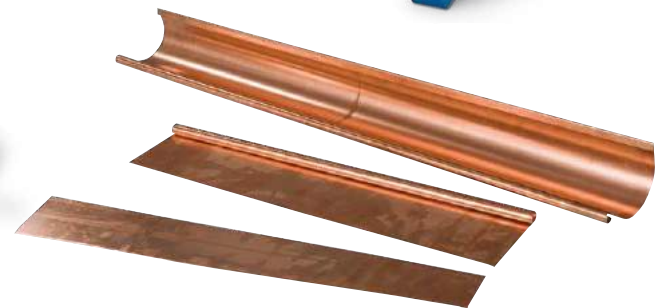

1 machine - 4 application options

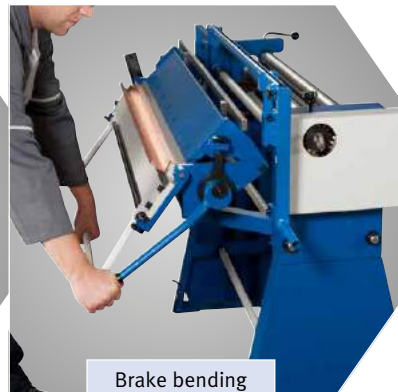
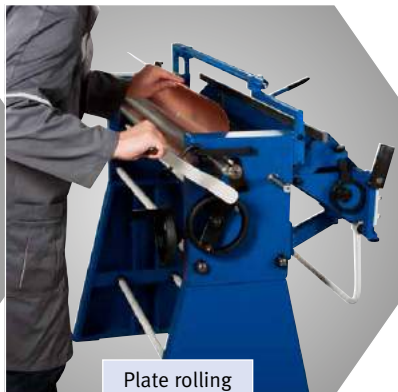

SRWS KOMBI - Combined machine for plate rolling, brake bending, cutting and beading

Technical specifications	Cutting capacity	Plate rolling capacity	Brake bending capacity	Beading capacity	Dimensions L x W x H in	Weight	Art. no.
SRWS 1020 KOMBI	0.8 mm	1 020 x 1.0 mm	1 020 x 1.5 mm	1 020 x 0.6 mm	1 490 x 850 x 1 300 mm	290 kg	3778001

* Data relate to cutting zinc sheet

HSBM – Manual brake bending machine

- ▶ Inexpensive entry-level models for trades
- ▶ Simple design and rugged manufacture guarantee precise work
- ▶ Safe clamping of the workpiece with clamping device

HSBM 305 HS and HSBM 610 HS

- ▶ Segmented upper beam
- ▶ Ideal for creating any kind of section including boxes with circumferential edge bending
- ▶ User-friendly adjustment of the top beam via eccentric
- ▶ Top beam for U sections with tall bent edges
- ▶ Brake bending via bow handle
- ▶ Easy to transport

HSBM 1020-10

- ▶ User-friendly adjustment of the top beam
- ▶ Brake bending via double handle



HSBM 610 HS

Passageway 25 mm here



HSBM 1020-10

Type	Segmentation
HSBM 305 HS	25-50-50-75-100 mm
HSBM 610 HS	25-50-75-205-255 mm

Model	HSBM 305 HS	HSBM 610 HS	HSBM 1020-10
Art. no.	3772305	3772610	3771020

Technical specifications	HSBM 305 HS	HSBM 610 HS	HSBM 1020-10
Max. working width	305 mm	610 mm	1 020 mm
Max. sheet thickness*	1.0 mm	1.0 mm	1.0 mm
Max. bending angle	135°	135°	135°
Weight	30 kg	42 kg	105 kg
Dimensions	500 x 350 x 410 mm	850 x 360 x 420 mm	1 276 x 550 x 975 mm

* Performance details relate to material with a tensile strength 400 N/mm²; optional hardened tool required for bending VA steel

Accessories for HSBM 1020-10	Art. no.
Tempered top beam	3772700

Manual brake bending machine

HSBM 3200-0.7 – Manual brake bending machine with detachable disc shears

Rugged, versatile and mobile

- ▶ Ideal for roofers and plumbers on site, e.g. for creating bay window panelling, flashings or chimney claddings
- ▶ Chassis and bending machine can be transported separately and easily assembled, and are thus ideal for the building site
- ▶ Chassis height adjustable by 152 mm
- ▶ The removable roller shears allow for precise cutting of aluminium, copper and zinc sheet
- ▶ Simple design and rugged manufacture guarantee precise work

Easy operation and easy on the material

- ▶ Robust clamping of the top jaws via two manual levers
- ▶ Brake bending possible using four manual levers
- ▶ Bending scale from 0 - 120 ° and length scale from 0 - 3 200 mm integrated in the machine
- ▶ Silicone insert on bottom jaws protects the material

› Large bending width of 3200 mm and still easy to transport
› Bending and trimming with a single machine



▶ Scale shows bending angles from 0 - 120°



▶ Disc shears for trimming the finished workpiece to the required length



▶ Length scale from 0 - 3 200 mm in mm and inches

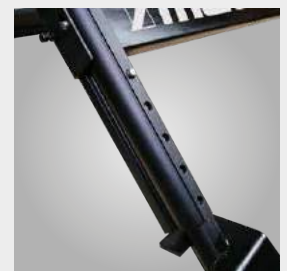

▶ Chassis height-adjustable by 152 mm

Model	HSBM 3200-0,7
Art. no.	3772320
Technical specifications	
Max. working width	3 200 mm
Max. sheet thickness steel 400 N/mm ²	0.7 mm
Max. sheet thickness stainless steel	0.4 mm
Max. sheet thickness aluminium	0.8 mm
Sheet infeed length max.	580 mm
Max. bending angle	155 °
Weight	122 kg
Length x width x height	3 200 x 1 250 x 1 325 mm
Max. height	1 477 mm

*Please turn over for descriptions of the packaging surcharges

flexCAT 3100 EOT-PRO – special vacuum for liquids with oil content and metal chips

- ▶ Easy vacuuming of, e.g., cooling lubricants or coarse metal swarf
- ▶ Ball valve for draining fluids
- ▶ Powder-coated steel frame as additional bump protection
- ▶ Integrated screen strainer system
- ▶ Stainless steel tank is not sensitive to damage from sharp edged metal swarf
- ▶ Large swarf strainer for collecting dry metal swarf
- ▶ Floatation switch for safe stop for full tank in wet vacuuming
- ▶ Metal hose connection on tank with locking mechanism
- ▶ With fill level display and visual fill level monitoring through transparent hose at side
- ▶ Trolley with non-marking fixed rollers at rear,

- and steering rollers with parking brake at front
- ▶ The special seal between the head and the tank is resistant against oil and chemical residues without compromising on flexibility
- ▶ Oil-resistant suction hose resilient to heavy loads and any kind of twisting
- ▶ Suction motors with noise damping to ensure quiet operation
- ▶ Three motors can be separately engaged
- ▶ Motors feature copper windings and "Amperometric Thermo Protection" motor circuit breaker



Stainless steel tank is not sensitive to damage from sharp edged metal swarf

Info & video



Model	flexCAT 3100 EOT-PRO
Art. no.	7003382

Technical specifications	
Vacuum cleaner type	wet & dry
Rating	3 600 W
Air volume	10 500 l/min
Tank volume	100 l
Hose diameter/length	50 mm/3 m
Number of motors	3
Motor cooling	Bypass
Sound pressure level	76 dB(A)
Electrical connection	230 V ~50 Hz
Motor speed	23 400 rpm
Cable length	8.5 m
Negative pressure	242 mbar
Tank material	stainless steel
Dimensions (L x W x H)	850 x 650 x 1 350 mm
Weight	65 kg

Hose and attachment set
oil-resistant Ø60 mm



Model	Nozzle set
Art. no.	7013423



Scope of delivery flexCAT 3100 EOT-PRO:

- ▶ Filter kit
- ▶ Nylon filter
- ▶ Screen for the container

Magnetic drilling
Deburring
Metal grinding
Cutting
Notching & punching
Bending
Presses
Circular saws
Roller conveyors
Metal-cutting band saws

Manual brake bending machine

HSBM SB – Manual brake bending machine, heavy-duty version with segmented upper tools

- ▶ Easy to use
- ▶ Segmented upper tools
- ▶ Brake bending function with safe clamping of the workpiece due to preload of the top beam
- ▶ Heavy, compact welded design
- ▶ For easy bending and precise adjustment of the bending angle thanks to stop with scale
- ▶ Very low maintenance requirements



HSBM 2020-20 SB

Type	Segmentation	Accessories HSBM 2020-20 SB					Art. no.
HSBM 2020-20 SB	25-30-35-40-45-75-100-150-200-200-270-400-400	Manual rear stop 0 - 500 mm					3772921
		Tempered top tools					3772922
Model	Max. working width	Sheet thickness max.*	Passageway between top + bottom beam max.	Bending angle max.	Weight	Dimensions L x W x H in mm	Art. no.
HSBM 2020-20 SB	2 020 mm	2.0 mm	120 mm	135°	1 020 kg	2 800 x 710 x 1 500	3772920

*Performance data for material with tensile strength of 400 N/mm²; bending performance stainless steel (VA) = factor 0.75; bending performance aluminium = 1.2; tempered top tools are necessary for bending stainless steel (VA);

MBM 1250 – Magnetic swivel bending machine with foot pedal

- ▶ Revolutionary simple, very fast and convenient operation
- ▶ Compact & space-saving
- ▶ Ideal for bending aluminium, copper, steel, stainless steel, etc.
- ▶ Bending angle adjustment to one degree of accuracy up to 170°
- ▶ Powerful electromagnetic system for optimum bending results
- ▶ Clamping across the entire width guarantees clean bending
- ▶ Segmentation in mm: 25 - 40 - 50 - 70 - 140 - 280 - 700 - 1250
- ▶ Very high bending capacity
- ▶ The main pressure is on the top beam, not on the machine
- ▶ The unique centreless hinges ensure precise force transfer at the bending point
- ▶ Rear stop, segmented top beam and foot pedal included in standard scope of supply



With practical compartments for all individual segments and bending rails



Push in slots for top beam segments

7 of many further bending options:

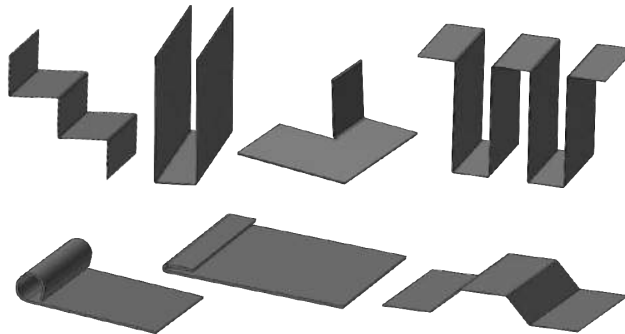

Model	MBM 1250
Art. no.	3770125

Technical specifications	
Max. bending width	1 250 mm
Holding pressure	6 t
Services	10 A
Dimensions	1 500 x 410 x 390 mm
Thermal protection	70 °C
Weight	150 kg
Workpiece thickness 1)	
Steel sheet 2)	1.6 mm 3) / 1.2 mm 4)
Aluminium sheet	1.6 mm 3) / 1.2 mm 4)
Copper, zinc, brass sheet	1.6 mm 3) / 1.2 mm 4)
Stainless steel sheet	1.0 mm 3) / 0.9 mm 4)

Note: Do not use this machine if you have a pacemaker.

1) For workpiece lengths of 1250 mm - greater material thickness may be possible for shorter workpieces 2) max. tensile strength 400 N/mm²

3) Bending beam extension - removed

4) Bending beam extension installed

Scope of delivery:

- ▶ Bending angle stop
- ▶ Bending beam width extension
- ▶ Rear stop
- ▶ Acute bending rail
- ▶ Narrow acute bending rail
- ▶ Segmented top beam
- ▶ Slotted bending rail
- ▶ 7 bending segments
- ▶ Foot pedal



Extremely fast and easy operation - in just a few steps, you can bend your sheet metal to the desired shape without any major overhead

Step 1

- ▶ Place the workpiece on the magnetic guide and adjust with respect to the bending edge.

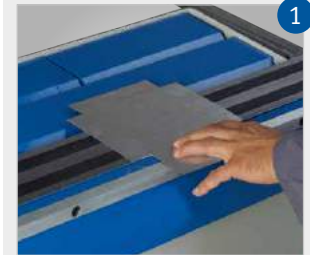

Step 2

- ▶ Select the required bending segment, position it on the workpiece and activate the magnet.



Step 3

- ▶ You can set the precise bending angle at the bending stop. Create a bend.



- ▶ Retooling for other bending actions is a matter of just a few steps.



Prepare to be fascinated!

For more information, check out our movie presentation on www.metalkraft.de !

Manual brake bending machines

HSBM N manual brake bending machine – universal deployment, extensible via various attachment kits

- ▶ The workpiece is clamped manually
- ▶ Easy fixing of the set bending angle, thus guaranteeing a high level of repetition accuracy
- ▶ Self-lubricating plain bearings
- ▶ The basic equipment can be converted at any time using optional attachment kits for a high upper beam, a high segmented upper beam, or a high segmented upper beam with a crowbar



Basic model extension kit (AB)	Max. working width	Max. sheet thickness*	Max. bending angle	Weight	Dimensions (LxWxH) in mm	Art. no.
HSBM 660 N	660 mm	2.00 mm	135°	56 kg	880 x 570/500 x 970	3770066
AB 660 H	660 mm	1.80 mm	93°	+ 8 kg	880 x 570/500 x 1060	3770067
AB 660 HS	660 mm	1.50 mm	93°	10 kg	880 x 570/500 x 1 070	3770068
HSBM 1050 N	1 050 mm	1.25 mm	135°	78 kg	1 250 x 570/500 x 970	3771050
AB 1050 H	1 050 mm	1.25 mm	93°	+ 13 kg	1 250 x 570/500 x 1 060	3771051
AB 1050 HS	1 050 mm	1.20 mm	93°	+ 16 kg	1 250 x 570/500 x 1 070	3771052
AB 1050 HSG	1 050 mm	1.20 mm	93°	+ 15 kg	1 250 x 570/500 x 1 070	3771053
HSBM 1300 N	1 300 mm	1.20 mm	135°	88 kg	1 480 x 570/500 x 970	3771300
AB 1300 H	1 300 mm	1.20 mm	93°	+ 16 kg	1 480 x 570/500 x 1 060	3771301
AB 1300 HS	1 300 mm	1.20 mm	93°	+ 20 kg	1 480 x 570/500 x 1 070	3771302
AB 1300 HSG	1 300 mm	1.20 mm	93°	+ 18 kg	1 480 x 570/500 x 1 070	3771303

*max. values relate to bending soft metals, e.g., aluminium

Variant	Description
N	with low top beam
H	with high top beam
S	with segment rail
G	with crow bar

Type	Segmentation
AB 660 HS	25-30-35-40-45-50-75-100-250
AB 1050 HS	25-30-35-40-45-50-75-100-150-200-270
AB 1050 HSG	25-30-35-40-45-50-75-100-150-200-270
AB 1300 HS	25-30-35-40-45-50-75-100-150-200-270-270
AB 1300 HSG	25-30-35-40-45-50-75-100-150-200-270-270

Accessories	Art. no.
Acute bending rail	
for HSBM 1 050 N	3790101
for HSBM 1 300 N	3790102
for AB 1050 H	3790103
for AB 1300 H	3790104
Plate rolling rail	
3.0 mm, length 660 mm	3790151
3.0 mm, length 1 050 mm	3790152
3.0 mm, length 1 300 mm	3790153
4.0 mm, length 660 mm	3790161
4.0 mm, length 1 050 mm	3790162
4.0 mm, length 1 300 mm	3790163
5.0 mm, length 660 mm	3790171
5.0 mm, length 1 050 mm	3790172
5.0 mm, length 1 300 mm	3790173
Rear stop	
for HSBM 660	3791660
for HSBM 1050	3791050
for HSBM 1300	3791300
Roller shears	
Suitable HSBM N with lower bending beam	
for HSBM 1 050 N	3791051
for HSBM 1 300 N	3791301

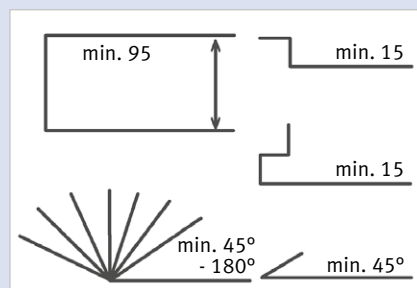

Bending examples
HSBM with low
and high top beam

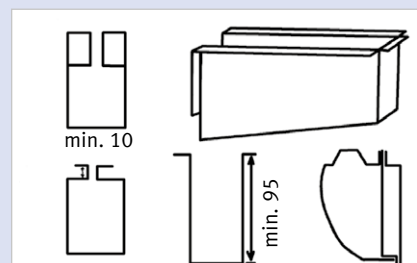

Bending examples;
HSBM with high top
beam, segment rail or
crowbar



Basic machine
HSBM N version

Passageway
25 mm



Optional acute bending rail



Optional plate rolling rail

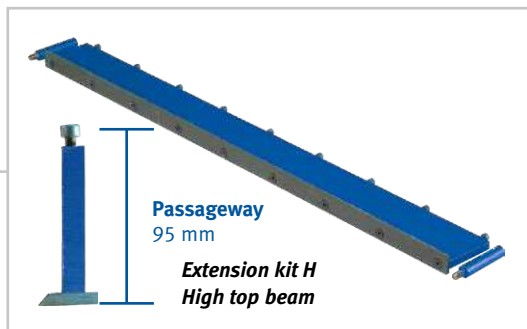

Passageway
95 mm

Extension kit H
High top beam



HSBM with extension kit
H version



HS extension kit
High segmented top beam



HSBM with extension kit
HS version



HSG extension kit
High segmented top beam with crowbar



HSBM with extension kit
HSG version

Manual brake bending machines

FSBM – Manual brake bending machines with foot pedal operated workpiece clamping

- ▶ Foot pedal operated workpiece clamping leaves both hands free for feeding in the material
- ▶ Different tool variants available E, S2, HS2 and HSG
- ▶ The powerful servo-cylinder facilitates bending
- ▶ Passageway between top + bottom beam up to 25 mm
- ▶ Self-lubricating plain bearings
- ▶ Clamping pressure on the top beam easily adjustable through knurled screws
- ▶ Material thickness setting through knurled screw
- ▶ Adjustable stop for bending angle



FSBM 2020-12 E
With segmented acute bending tools, full-width bending rail and full-width support bed

Model	Max. working width	Max. sheet thickness* Steel 235 N/mm ²	Max. sheet thickness VA steel	Max. bending angle	Weight	Dimensions L x W x H	Art. no.
FSBM 1020-25 E	1 020 mm	2.5 mm	1.5 mm	135°	290 kg	1 350 x 800 x 1 130 mm	3772125
FSBM 1020-20 S2	1 020 mm	2.0 mm	1.2 mm	135°	325 kg	1 350 x 800 x 1 130 mm	3772102
FSBM 1020-20 HSG**	1 020 mm	2.0 mm	1.2 mm	150°	360 kg	1 280 x 620 x 1 200 mm	3770103
FSBM 1270-20 E	1 270 mm	2.0 mm	1.2 mm	135°	340 kg	1 600 x 800 x 1 130 mm	3772127
FSBM 1270-20 HS2	1 270 mm	2.0 mm	1.2 mm	135°	370 kg	1 600 x 800 x 1 130 mm	3772128
FSBM 1520-15 E	1 520 mm	1.5 mm	0.9 mm	135°	415 kg	1 850 x 770 x 1 130 mm	3772129
FSBM 2020-12 E	2 020 mm	1.2 mm	0.7 mm	135°	540 kg	2 290 x 820 x 1 180 mm	3772130

*Performance data for material with tensile strength of 235 N/mm²; bending performance stainless steel (VA) = factor 0.75;

bending performance aluminium = 1.2; tempered top tools are necessary for bending stainless steel (VA);**Segments have a hardness of HRC24-26

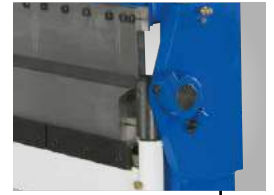

FSBM 1270-20 E

With segmented acute bending tools, full-width bending rail and full-width support bed



FSBM 1020-20 S2

With segmented acute bending tools, segmented bending rail and full-width support bed



FSBM 1020-20 HSG

With high, segmented top beam, segmented support bed and segmented bending beam as standard

Dimensions E series:

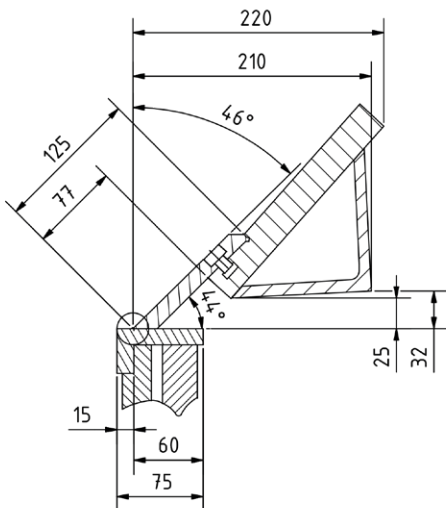

Dimensions S2 / HS2 series:

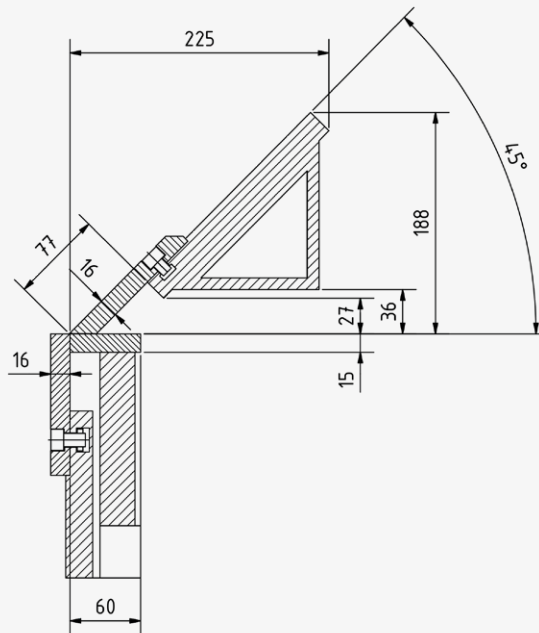

Dimensions HSG series:

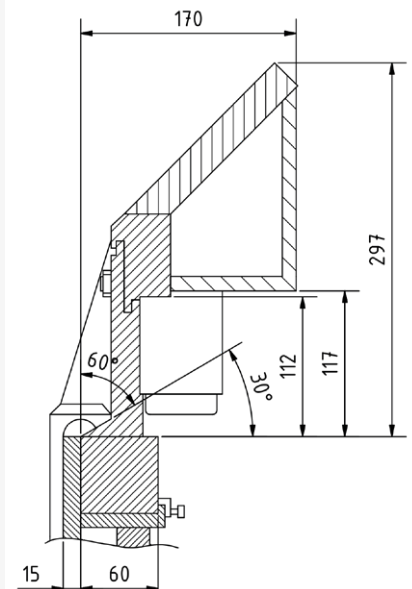

Max. passageway between top tool and support bed 25mm

Type	Segmentation
FSBM 1020-25 E	25-30-35-40-45-50-75-100-150-200-270 mm
FSBM 1020-20 S2	25-30-35-40-45-50-75-100-150-200-270 mm
FSBM 1020-20 HSG	25-30-35-40-45-50-75-100-150-200-270 mm
FSBM 1270-20 E	25-30-35-40-45-50-75-100-150-200-250-270 mm
FSBM 1270-20 HS2	25-30-35-40-45-50-75-100-150-200-250-270 mm
FSBM 1520-15 E	25-30-35-40-45-50-75-100-150-200-250-270 mm
FSBM 2020-12 E	25-30-35-40-45-50-75-100-150-200-250-270-500 mm

Option	Art. no.
Tempered segments FSBM 1020-25 E*	3772702
Tempered segments FSBM 1020-20 S2*	3772701
Tempered segments FSBM 1270-20 E*	3772703
Tempered segments FSBM 1270-20 HS2*	3772703
Tempered segments FSBM 1520-15 E*	3772704

*Only the top tool is tempered

Accessories	Art. no.
Rear stop up to 300 mm New (fits 3772102, 3772125, 3772127, 3772128)	3772720

Manual brake bending machines

HSBM – Manual brake bending machines, heavy-duty versions



- ▶ Easy to use
- ▶ Heavy, compact welded design
- ▶ Very low maintenance requirements
- ▶ With full-width acute bending rail

- ▶ For easy bending and precise adjustment of the bending angle thanks to stop with scale
- ▶ Sheet thickness can be set via bending beam

S models

- ▶ With segmented top tools

SH models

- ▶ With high, segmented crowbar tools



Type	Segmentation HSBM S / HSBM SH
HSBM 1520-20 S / SH	25-30-35-40-45-50-75-100-150-220-250-500
HSBM 2020-20 S / SH	25-30-35-40-45-50-75-100-150-200-200-270-400-400
HSBM 2520-16 S / SH	25-30-35-40-45-50-75-100-150-200-200-270-400-400-500
HSBM 3020-12 S / SH	25-30-35-40-45-50-75-100-150-200-200-270-400-400-500-500

More brake bending machines
available on request!

Model	Max. working width	Sheet thickness max.*	Passageway between top + bottom beam max.	Bending angle max.	Weight	Dimensions L x W x H in mm	Art. no.			
HSBM 1520-20	1 520 mm	2.0 mm	140 mm	135°	850 kg	2 680 x 560 x 1 255	3779001			
HSBM 2020-20	2 020 mm	2.0 mm	140 mm	135°	1 130 kg	2 695 x 560 x 1 255	3779002			
HSBM 2520-16	2 520 mm	1.6 mm	140 mm	135°	1 320 kg	3 195 x 560 x 1 255	3779003			
HSBM 3020-12	3 020 mm	1.2 mm	140 mm	135°	1 900 kg	3 695 x 560 x 1 255	3779004			
HSBM 1520-20 S	1 520 mm	2.0 mm	140 mm	135°	850 kg	2 680 x 560 x 1 255	3779010			
HSBM 2020-20 S	2 020 mm	2.0 mm	140 mm	135°	1 080 kg	2 695 x 560 x 1 255	3779011			
HSBM 2520-16 S	2 520 mm	1.6 mm	140 mm	135°	1 320 kg	3 195 x 560 x 1 255	3779012			
HSBM 3020-12 S	3 020 mm	1.2 mm	140 mm	135°	1 900 kg	3 695 x 560 x 1 255	3779013			
HSBM 1520-20 SH	1 520 mm	2.0 mm	140 mm	93°	850 kg	2 680 x 560 x 1255	3779020			
HSBM 2020-20 SH	2 020 mm	2.0 mm	140 mm	93°	1 080 kg	2 695 x 560 x 1 255	3779021			
HSBM 2520-16 SH	2 520 mm	1.6 mm	140 mm	93°	1 320 kg	3 195 x 560 x 1 255	3779022			
HSBM 3020-12 SH	3 020 mm	1.2 mm	140 mm	93°	1 900 kg	3 695 x 560 x 1 255	3779023			

*Performance data for material with tensile strength of 400 N/mm²; bending performance stainless steel (VA) = factor 0.75; bending performance aluminium = 1.2; optional tempering of the material is necessary for bending stainless steel (VA);

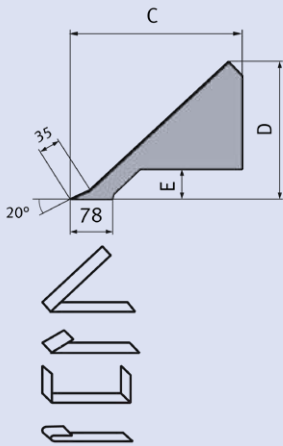

Dimensions
Bending beam HSBM

L	C	D	E
1500	340	305	49
2000	340	305	49
2500	345	310	49
3000	345	310	49

Width of bending rail 20 mm

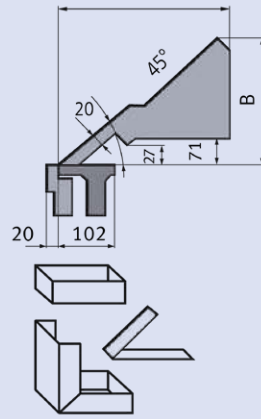

Dimensions
Bending beam HSBM S

L	A	B
1500	360	335
2000	360	335
2500	370	340
3000	370	340

Width of bending rail 20 mm

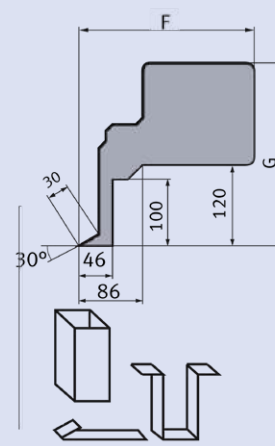

Dimensions
Bending beam HSBM SH

L	F	G
1500	290	320
2000	290	320
2500	310	340
3000	310	340

Width of bending rail 20 mm



► Easy, manual adjustment of the bending angle thanks to stop with scale

Accessories



► Roller shears for sheet thicknesses up to 0.8 mm

Accessories



► Rear stop with hand wheel and measuring device



HSBM 3020-12

HSBM 1520-20 S

Accessories HSBM 1520-20 / S / SH	Art. no.
Rear stop with two arms, T grooves and tilting cams, 100 - 1 000 mm	3797000
Rear stop with hand wheel, measuring device and full-width beam, 75 - 760 mm	3797010
Roller shears for sheet thicknesses up to 0.8 mm	3797030
Option HSBM 1520-20 / S / SH (ex works only!)	Art. no.
Rear stop, hand wheel, measuring device and stop fingers 6 - 760 mm	3797020

Accessories HSBM 2520-16 / S / SH	Art. no.
Rear stop with two arms, T grooves and tilting cams, 100 - 1 000 mm	3797002
Rear stop with hand wheel, measuring device and full-width beam, 75 - 760 mm	3797012
Roller shears for sheet thicknesses up to 0.8 mm	3797032
Option HSBM 2520-16 / S / SH (ex works only!)	Art. no.
Rear stop, hand wheel, measuring device and stop fingers 6 - 760 mm	3797022

Accessories HSBM 2020-20 / S / SH	Art. no.
Rear stop with two arms, T grooves and tilting cams, 100 - 1 000 mm	3797001
Rear stop with hand wheel, measuring device and full-width beam, 75 - 760 mm	3797011
Roller shears for sheet thicknesses up to 0.8 mm	3797031
Option HSBM 2020-20 / S / SH (ex works only!)	Art. no.
Rear stop, hand wheel, measuring device and stop fingers 6 - 760 mm	3797021

Accessories HSBM 3020-12 / S / SH	Art. no.
Rear stop with two arms, T grooves and tilting cams, 100 - 1 000 mm	3797003
Rear stop with hand wheel, measuring device and full-width beam, 75 - 760 mm	3797013
Roller shears for sheet thicknesses up to 0.8 mm	3797033
Option HSBM 3020-12 / S / SH (ex works only!)	Art. no.
Rear stop, hand wheel, measuring device and stop fingers 6 - 760 mm	3797023

Semi-motorised brake bending machines

MSBM – Semi-motorised brake bending machines, heavy-duty versions, foot-operated



- ▶ Semi-motorised version - manual top beam operation, motorised bending operation
- ▶ Developed for professional use
- ▶ Foot-operated
- ▶ Heavy, compact welded design

- ▶ With full-width acute bending rail
- ▶ With manual bending angle adjustment through ring scale as standard
- ▶ Very low maintenance requirements

S models

- ▶ With segmented top tools

SH models

- ▶ With high, segmented crowbar tools



Type	Segmentation MSBM S / MSBM SH
MSBM 1520-30 S / SH	25-30-35-40-45-50-75-100-150-220-250-500
MSBM 2020-25 S / SH	25-30-35-40-45-50-75-100-150-200-270-400-400
MSBM 2520-20 S / SH	25-30-35-40-45-50-75-100-150-200-270-400-400-500
MSBM 3020-15 S / SH	25-30-35-40-45-50-75-100-150-200-270-400-400-500-500

More brake bending machines available on request!

Model	Max. working width	Sheet thickness max.*	Passageway between top + bottom beam max.	Bending angle max.	Weight	Dimensions L x W x H in mm	Art. no.
MSBM 1520-30	1 520 mm	3.0 mm	140 mm	1.1 kW	1 060 kg	2 475 x 560 x 1 290	3779030
MSBM 2020-25	2 020 mm	2.5 mm	140 mm	1.1 kW	1 450 kg	2 975 x 560 x 1 290	3779031
MSBM 2520-20	2 520 mm	2.0 mm	140 mm	1.1 kW	1 780 kg	3 475 x 560 x 1 290	3779032
MSBM 3020-15	3 020 mm	1.5 mm	140 mm	1.1 kW	2 200 kg	3 975 x 560 x 1 290	3779033
MSBM 1520-30 S	1 520 mm	3.0 mm	140 mm	1.1 kW	1 060 kg	2 475 x 560 x 1 290	3779040
MSBM 2020-25 S	2 020 mm	2.5 mm	140 mm	1.1 kW	1 450 kg	2 975 x 560 x 1 290	3779041
MSBM 2520-20 S	2 520 mm	2.0 mm	140 mm	1.1 kW	1 780 kg	3 475 x 560 x 1 290	3779042
MSBM 3020-15 S	3 020 mm	1.5 mm	140 mm	1.1 kW	2 200 kg	3 975 x 560 x 1 290	3779043
MSBM 1520-30 SH	1 520 mm	3.0 mm	140 mm	1.1 kW	1060 kg	2 475 x 560 x 1 290	3779050
MSBM 2020-25 SH	2 020 mm	2.5 mm	140 mm	1.1 kW	1450 kg	2 975 x 560 x 1 290	3779051
MSBM 2520-20 SH	2 520 mm	2.0 mm	140 mm	1.1 kW	1780 kg	3 475 x 560 x 1 290	3779052
MSBM 3020-15 SH	3 020 mm	1.5 mm	140 mm	1.1 kW	2 200 kg	3 975 x 560 x 1 290	3779053

*Performance data for material with tensile strength of 400 N/mm²; bending performance stainless steel (VA) = factor 0.75; bending performance aluminium = 1.2; optional tempering of the material is necessary for bending stainless steel (VA);

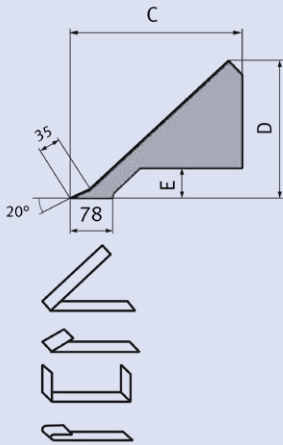

Dimensions
Bending beam MSBM

L	C	D	E
1500	340	305	49
2000	340	305	49
2500	345	310	49
3000	345	310	49

Width of bending rail 20 mm

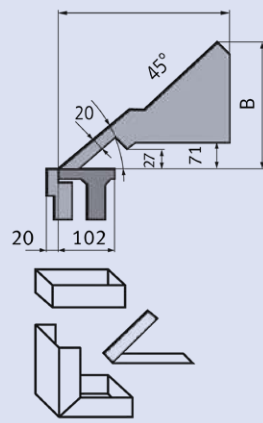

Dimensions
Bending beam MSBM S

L	A	B
1 500	360	335
2 000	360	335
2 500	370	340
3 000	370	340

Width of bending rail 20 mm

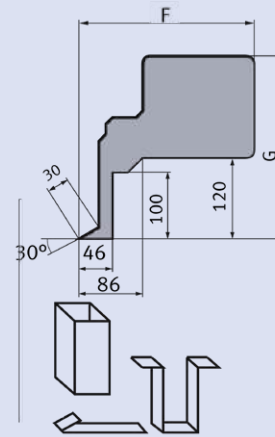

Dimensions
Bending beam MSBM SH

L	F	G
1 500	290	320
2 000	290	320
2 500	310	340
3 000	310	340

Width of bending rail 20 mm



► **Standard control MA**, manual adjustment of bending angle via ring scale on left side of machine

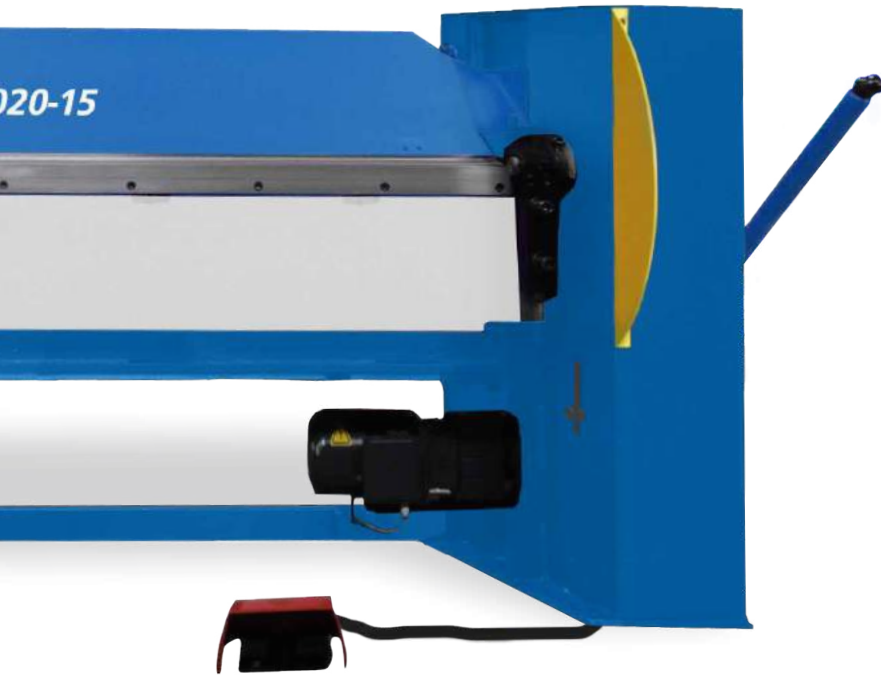

Accessories MSBM 1520-30 / S / SH	Art. no.
Rear stop with two arms, T grooves and tilting cams, 100 - 1 000 mm	3797005
Rear stop with hand wheel, measuring device and full-width beam, 75 - 760 mm	3797010
Rear stop, hand wheel, measuring device and stop fingers 6 - 760 mm	3797020
Roller shears for sheet thicknesses up to 0.8 mm	3797030

Accessories MSBM 2020-25 / S / SH	Art. no.
Rear stop with two arms, T grooves and tilting cams, 100 - 1 000 mm	3797006
Rear stop with hand wheel, measuring device and full-width beam, 75 - 760 mm	3797011
Rear stop, hand wheel, measuring device and stop fingers 6 - 760 mm	3797021
Roller shears for sheet thicknesses up to 0.8 mm	3797031

Accessories MSBM 2520-20 / S / SH	Art. no.
Rear stop with two arms, T grooves and tilting cams, 100 - 1 000 mm	3797007
Rear stop with hand wheel, measuring device and full-width beam, 75 - 760 mm	3797012
Rear stop, hand wheel, measuring device and stop fingers 6 - 760 mm	3797022
Roller shears for sheet thicknesses up to 0.8 mm	3797032

Accessories MSBM 3020-15 / S / SH	Art. no.
Rear stop with two arms, T grooves and tilting cams, 100 - 1 000 mm	3797008
Rear stop with hand wheel, measuring device and full-width beam, 75 - 760 mm	3797013
Rear stop, hand wheel, measuring device and stop fingers 6 - 760 mm	3797023
Roller shears for sheet thicknesses up to 0.8 mm	3797033

! **Tempering of standard tools on request!**

• Tempered acute bending rail and bending rail / Tempered segmented tools and bending rail / Tempered segmented crowbar tools and bending rail

Motorised brake bending machines

MSBM PRO – Motorised brake bending machines, heavy-duty type for sheet thicknesses up to 1.75 mm



- ▶ Suitable for sheet thicknesses up to 1.75 mm
- ▶ Foot-operated
- ▶ Heavy, compact welded design
- ▶ Powerful drive thanks to Lenze motors
- ▶ With full-width acute bending rail
- ▶ With manual bending angle adjustment as standard
- ▶ Very low maintenance requirements
- ▶ Motorised workpiece clamping via foot pedal
- S models**
- ▶ With segmented top tools
- SH models**
- ▶ With high, segmented crowbar tools



MSBM 2020-15 PRO S

Type	Segmentation MSBM PRO S / MSBM SH
MSBM 1520-17 PRO S / SH	25-30-35-40-45-50-75-100-150-220-250-500
MSBM 2020-15 PRO S / SH	25-30-35-40-45-50-75-100-150-200-200-270-400-400
MSBM 2520-12 PRO S / SH	25-30-35-40-45-50-75-100-150-200-200-270-400-400-500
MSBM 3020-10 PRO S / SH	25-30-35-40-45-50-75-100-150-200-200-270-400-400-500-500

More brake bending machines available on request!

Model	Max. working width	Sheet thickness max.*	Passageway between top + bottom beam max.	Motor output		Weight	Dimensions L x W x H in mm	Art. no.
				Beam	Bending			
MSBM 1520-17 PRO	1 520 mm	1.75 mm	110 mm	0.37 kW	0.75 kW	810 kg	2 150 x 700 x 1 100	3779060
MSBM 2020-15 PRO	2 020 mm	1.5 mm	110 mm	0.37 kW	0.75 kW	1 050 kg	2 650 x 700 x 1 100	3779061
MSBM 2520-12 PRO	2 520 mm	1.25 mm	110 mm	0.37 kW	0.75 kW	1 290 kg	3 150 x 700 x 1 100	3779062
MSBM 3020-10 PRO	3 020 mm	1.0 mm	110 mm	0.37 kW	0.75 kW	1 610 kg	3 650 x 700 x 1 100	3779063
MSBM 1520-17 PRO S	1 520 mm	1.75 mm	110 mm	0.37 kW	0.75 kW	810 kg	2 150 x 700 x 1 100	3779070
MSBM 2020-15 PRO S	2 020 mm	1.5 mm	110 mm	0.37 kW	0.75 kW	1 050 kg	2 650 x 700 x 1 100	3779071
MSBM 2520-12 PRO S	2 520 mm	1.25 mm	110 mm	0.37 kW	0.75 kW	1 290 kg	3 150 x 700 x 1 100	3779072
MSBM 3020-10 PRO S	3 020 mm	1.0 mm	110 mm	0.37 kW	0.75 kW	1 610 kg	3 650 x 700 x 1 100	3779073
MSBM 1520-17 PRO SH	1 520 mm	1.75 mm	110 mm	0.37 kW	0.75 kW	810 kg	2 150 x 700 x 1 100	3779080
MSBM 2020-15 PRO SH	2 020 mm	1.5 mm	110 mm	0.37 kW	0.75 kW	1 050 kg	2 650 x 700 x 1 100	3779081
MSBM 2520-12 PRO SH	2 520 mm	1.25 mm	110 mm	0.37 kW	0.75 kW	1 290 kg	3 150 x 700 x 1 100	3779082
MSBM 3020-10 PRO SH	3 020 mm	1.0 mm	110 mm	0.37 kW	0.75 kW	1 610 kg	3 650 x 700 x 1 100	3779083

*Performance data for material with tensile strength of 400 N/mm²; bending performance stainless steel (VA) = factor 0.75; bending performance aluminium = 1.2; optional tempering of the material is necessary for bending stainless steel (VA);

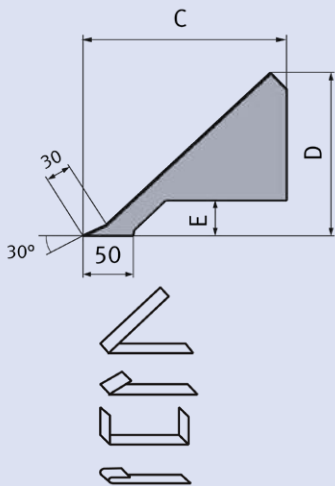

Dimensions
Bending beam MSBM

L	C	D	E
1 500	225	200	44
2 000	258	232	44
2 500	258	232	44
3 000	262	232	44

Width of bending rail 15 mm

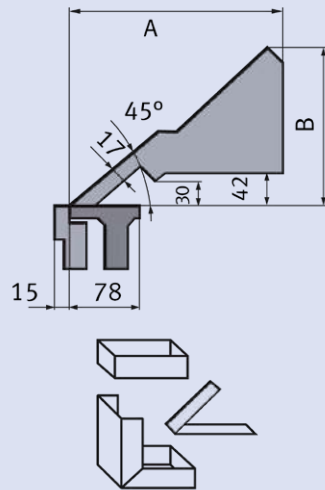

Dimensions
Bending beam MSBM S

L	A	B
1 500	258	215
2 000	258	215
2 500	310	265
3 000	343	303

Width of bending rail 15 mm

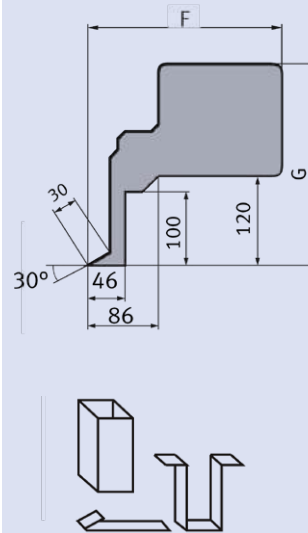

Dimensions
Bending beam MSBM SH

L	F	G
1 500	270	300
2 000	290	320
2 500	290	320
3 000	290	320

Width of bending rail 15 mm



► **Standard control MA**, manual adjustment of bending angle via ring scale on left side of machine



► **Optional control PT 1** - Manual adjustment of bending angle via potentiometer conveniently from the front of the machine



► **Optional control PUD** with digital display, manual bending angle adjustment and adjustable, motorised rear stop



► **Optional control Schneider CNC2A**, two-axis control for digital angle input and input of the rear stop position with the option of storing bending sequences, motorised rear stop with stop fingers, travel range 15-1 000 mm

Accessories (all models)	Art. no.
Control PT 1, bending angle adjustment via potentiometer on face side of machine	3797160
Control Schneider TM 238, bending angle adjustment via touchscreen on NC control, storing of bending sequences possible	3797500



► **Optional control Schneider TM 238**, single-axis control for digital angle input via generously dimensioned touchscreen with the option of storing bending sequences

Accessories MSBM 1520-17 PRO / S / SH	Art. no.
Rear stop with two arms, T grooves and tilting cams, 100 - 1 000 mm	3797005
Rear stop with hand wheel, measuring device and full-width beam, 75 - 760 mm	3797010
Rear stop with hand wheel, measuring device and stop fingers 6 - 760 mm	3797020
Control PUD, bending angle adjustment via potentiometer PT 1, motorised rear stop with stop fingers and digital position display, 15-1 000 mm	3797040
Control Schneider CNC2A, bending angle and rear stop adjustment via touchscreen on NC control, motorised rear stop with stop fingers, 15-1 000 mm, storing of edging sequences possible	3797505

Accessories MSBM 2020-15 PRO / S / SH	Art. no.
Rear stop with two arms, T grooves and tilting cams, 100 - 1 000 mm	3797006
Rear stop with hand wheel, measuring device and full-width beam, 75 - 760 mm	3797011
Rear stop with hand wheel, measuring device and stop fingers 6 - 760 mm	3797021
Control PUD, bending angle adjustment via potentiometer PT 1, motorised rear stop with stop fingers and digital position display, 15-1 000 mm	3797041
Control Schneider CNC2A, bending angle and rear stop adjustment via touchscreen on NC control, motorised rear stop with stop fingers, 15-1 000 mm, storing of edging sequences possible	3797506

Accessories MSBM 2520-12 PRO / S / SH	Art. no.
Rear stop with two arms, T grooves and tilting cams, 100 - 1 000 mm	3797007
Rear stop with hand wheel, measuring device and full-width beam, 75 - 760 mm	3797012
Rear stop with hand wheel, measuring device and stop fingers 6 - 760 mm	3797022
Control PUD, bending angle adjustment via potentiometer PT 1, motorised rear stop with stop fingers and digital position display, 15-1 000 mm	3797042
Control Schneider CNC2A, bending angle and rear stop adjustment via touchscreen on NC control, motorised rear stop with stop fingers, 15-1 000 mm, storing of edging sequences possible	3797507

Accessories MSBM 3020-10 PRO / S / SH	Art. no.
Rear stop with two arms, T grooves and tilting cams, 100 - 1 000 mm	3797008
Rear stop with hand wheel, measuring device and full-width beam, 75 - 760 mm	3797013
Rear stop with hand wheel, measuring device and stop fingers 6 - 760 mm	3797023
Control PUD, bending angle adjustment via potentiometer PT 1, motorised rear stop with stop fingers and digital position display, 15-1 000 mm	3797043
Control Schneider CNC2A, bending angle and rear stop adjustment via touchscreen on NC control, motorised rear stop with stop fingers, 15-1 000 mm, storing of edging sequences possible	3797508

Tempering of standard tools on request!

- Tempered acute bending rail and bending rail
- Tempered segmented tools and bending rail
- Tempered segmented crowbar tools and bending rail

Motorised brake bending machines

MSBM PRO – Motorised brake bending machines, heavy-duty type for sheet thicknesses up to 3.5 mm



- ▶ Suitable for sheet thicknesses up to 3.5 mm
- ▶ Foot-operated
- ▶ Heavy, compact welded design
- ▶ Powerful drive thanks to Lenze motors
- ▶ With full-width acute bending rail

- ▶ With manual bending angle adjustment as standard
- ▶ Very low maintenance requirements
- ▶ Motorised workpiece clamping

S models

- ▶ With segmented top tools

SH models

- ▶ With high, segmented crowbar tools

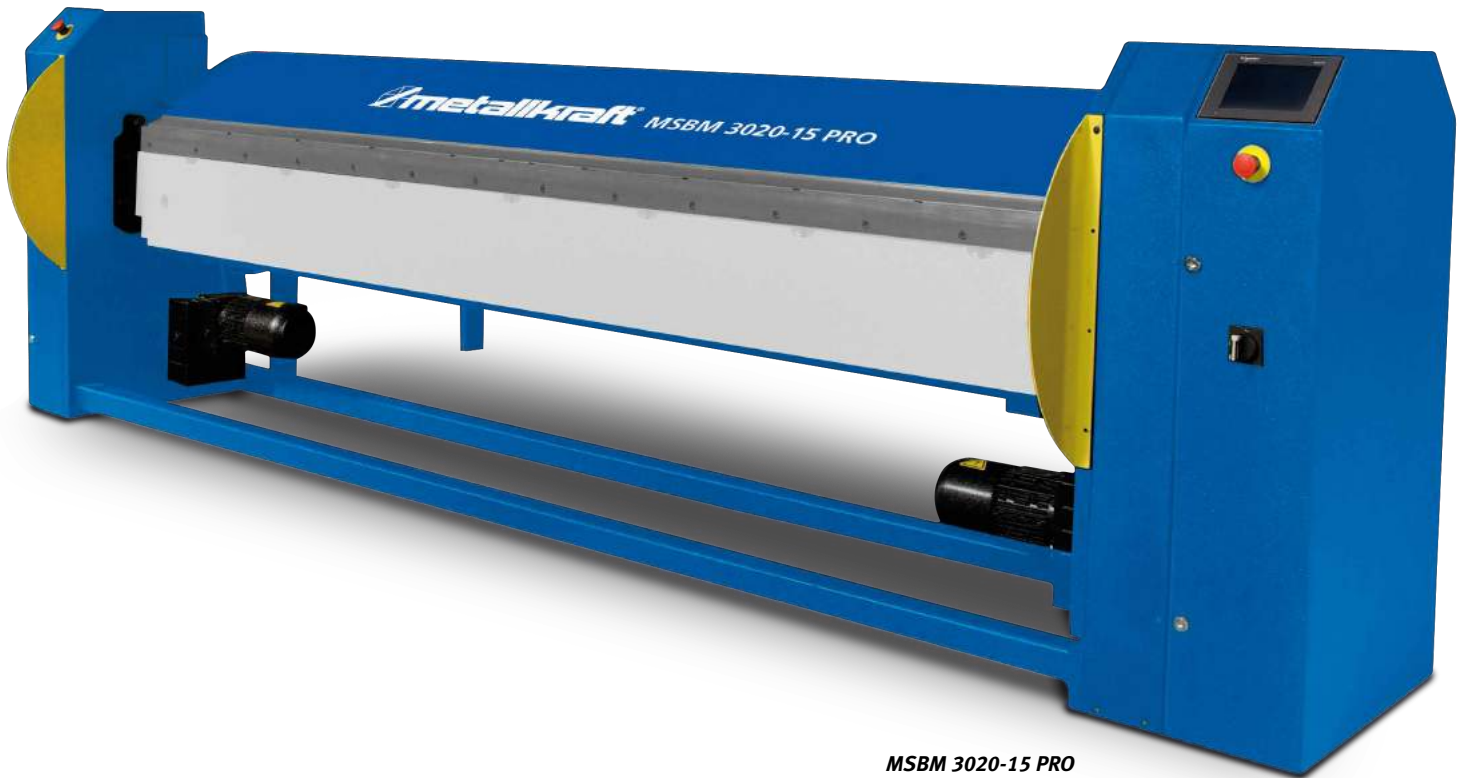

MSBM 3020-15 PRO
With optional control TM 238

Type	Segmentation MSBM PRO S / MSBM SH
MSBM 1020-30 PRO S / SH	25-30-35-40-45-50-75-100-150-220-250
MSBM 1520-30 PRO S / SH	25-30-35-40-45-50-75-100-150-220-250-500
MSBM 2020-25 PRO S / SH	25-30-35-40-45-50-75-100-150-200-200-270-400-400
MSBM 2520-20 PRO S / SH	25-30-35-40-45-50-75-100-150-200-200-270-400-400-500
MSBM 3020-15 PRO S / SH	25-30-35-40-45-50-75-100-150-200-200-270-400-400-500-500

More brake bending machines available on request!

Model	Max. working width	Sheet thickness max.*	Passageway between top + bottom beam max.	Motor output		Weight	Dimensions L x W x H in mm	Art. no.
				Beam	Bending			
MSBM 1020-35 PRO	1 020 mm	3.5 mm	140 mm	0.75 kW	1.1 kW	860 kg	1 350 x 710 x 1 160	3779089
MSBM 1520-30 PRO	1 520 mm	3.0 mm	140 mm	0.75 kW	1.1 kW	1 060 kg	2 350 x 710 x 1 160	3779090
MSBM 2020-25 PRO	2 020 mm	2.5 mm	140 mm	0.75 kW	1.1 kW	1 380 kg	2 850 x 710 x 1 160	3779091
MSBM 2520-20 PRO	2 520 mm	2.0 mm	140 mm	0.75 kW	1.1 kW	1 780 kg	3 350 x 710 x 1 160	3779092
MSBM 3020-15 PRO	3 020 mm	1.5 mm	140 mm	0.75 kW	1.1 kW	2 200 kg	3 850 x 710 x 1 160	3779093
MSBM 1020-35 PRO S	1 020 mm	3.5 mm	140 mm	0.75 kW	1.1 kW	860 kg	1 350 x 710 x 1 160	3779099
MSBM 1520-30 PRO S	1 520 mm	3.0 mm	140 mm	0.75 kW	1.1 kW	1 060 kg	2 350 x 710 x 1 160	3779100
MSBM 2020-25 PRO S	2 020 mm	2.5 mm	140 mm	0.75 kW	1.1 kW	1 380 kg	2 850 x 710 x 1 160	3779101
MSBM 2520-20 PRO S	2 520 mm	2.0 mm	140 mm	0.75 kW	1.1 kW	1 780 kg	3 350 x 710 x 1 160	3779102
MSBM 3020-15 PRO S	3 020 mm	1.5 mm	140 mm	0.75 kW	1.1 kW	2 200 kg	3 850 x 710 x 1 160	3779103
MSBM 1020-35 PRO SH	1 020 mm	3.5 mm	140 mm	0.75 kW	1.1 kW	860 kg	1 350 x 710 x 1 160	3779109
MSBM 1520-30 PRO SH	1 520 mm	3.0 mm	140 mm	0.75 kW	1.1 kW	1 060 kg	2 350 x 710 x 1 160	3779110
MSBM 2020-25 PRO SH	2 020 mm	2.5 mm	140 mm	0.75 kW	1.1 kW	1 380 kg	2 850 x 710 x 1 160	3779111
MSBM 2520-20 PRO SH	2 520 mm	2.0 mm	140 mm	0.75 kW	1.1 kW	1 780 kg	3 350 x 710 x 1 160	3779112
MSBM 3020-15 PRO SH	3 020 mm	1.5 mm	140 mm	0.75 kW	1.1 kW	2 200 kg	3 850 x 710 x 1 160	3779113

*Performance data for material with tensile strength of 400 N/mm²; bending performance stainless steel (VA) = factor 0.75; bending performance aluminium = 1.2; optional tempering of the material is necessary for bending stainless steel (VA);

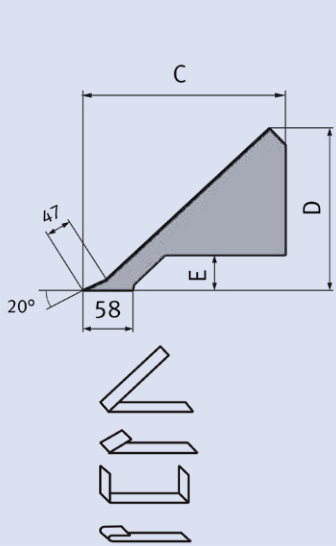

Dimensions
Bending beam MSBM

L	C	D	E
1 000	380	338	52
1 500	380	338	52
2 000	360	338	52
2 500	360	338	52
3 000	360	338	52

Width of bending rail 20 mm

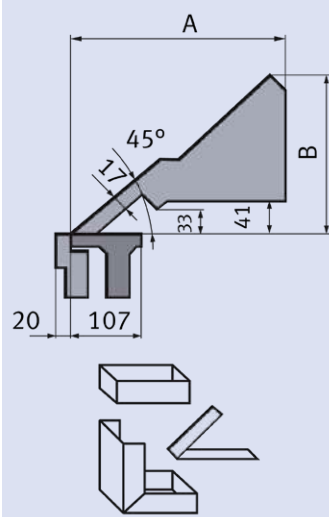

Dimensions
Bending beam MSBM S

L	A	B
1 000	350	310
1 500	350	310
2 000	350	310
2 500	355	315
3 000	355	315

Width of bending rail 20 mm

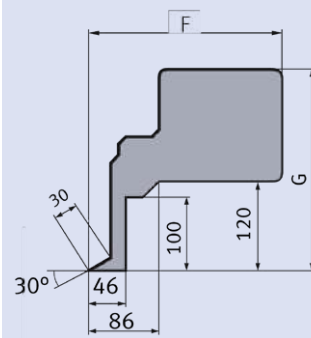

Dimensions
Bending beam MSBM SH

L	F	G
1 000	270	300
1 500	290	320
2 000	290	320
2 500	310	340
3 000	310	340

Width of bending rail 20 mm

Accessories (all models)

Accessories (all models)	Art. no.
Control PT 1, bending angle adjustment via potentiometer on face side of machine	3797160
Control Schneider TM 238, bending angle adjustment via touchscreen on NC control, storing of bending sequences possible	3797500

Accessories MSBM 1020-35 PRO / S / SH

Accessories MSBM 1020-35 PRO / S / SH	Art. no.
Rear stop with two arms, T grooves and tilting cams, 100 - 1 000 mm	3797005
Rear stop with hand wheel, measuring device and full-width beam, 75 - 760 mm	3797010
Rear stop with hand wheel, measuring device and stop fingers 6 - 760 mm	3797020
Control Schneider CNC2A, bending angle and rear stop adjustment via touchscreen on NC control, motorised rear stop with stop fingers, 15-1 000 mm, storing of edging sequences possible	3797504

Accessories MSBM 1520-30 PRO / S / SH

Accessories MSBM 1520-30 PRO / S / SH	Art. no.
Rear stop with two arms, T grooves and tilting cams, 100 - 1 000 mm	3797005
Rear stop with hand wheel, measuring device and full-width beam, 75 - 760 mm	3797010
Rear stop with hand wheel, measuring device and stop fingers 6 - 760 mm	3797020
Control Schneider CNC2A, bending angle and rear stop adjustment via touchscreen on NC control, motorised rear stop with stop fingers, 15-1 000 mm, storing of edging sequences possible	3797505

Accessories MSBM 2020-25 PRO / S / SH

Accessories MSBM 2020-25 PRO / S / SH	Art. no.
Rear stop with two arms, T grooves and tilting cams, 100 - 1 000 mm	3797006
Rear stop with hand wheel, measuring device and full-width beam, 75 - 760 mm	3797011
Rear stop with hand wheel, measuring device and stop fingers 6 - 760 mm	3797021
Control Schneider CNC2A, bending angle and rear stop adjustment via touchscreen on NC control, motorised rear stop with stop fingers, 15-1 000 mm, storing of edging sequences possible	3797506

Accessories MSBM 2520-20 PRO / S / SH

Accessories MSBM 2520-20 PRO / S / SH	Art. no.
Rear stop with two arms, T grooves and tilting cams, 100 - 1 000 mm	3797007
Rear stop with hand wheel, measuring device and full-width beam, 75 - 760 mm	3797012
Rear stop with hand wheel, measuring device and stop fingers 6 - 760 mm	3797022
Control Schneider CNC2A, bending angle and rear stop adjustment via touchscreen on NC control, motorised rear stop with stop fingers, 15-1 000 mm, storing of edging sequences possible	3797507

Accessories MSBM 3020-15 PRO / S / SH

Accessories MSBM 3020-15 PRO / S / SH	Art. no.
Rear stop with two arms, T grooves and tilting cams, 100 - 1 000 mm	3797008
Rear stop with hand wheel, measuring device and full-width beam, 75 - 760 mm	3797013
Rear stop with hand wheel, measuring device and stop fingers 6 - 760 mm	3797023
Control Schneider CNC2A, bending angle and rear stop adjustment via touchscreen on NC control, motorised rear stop with stop fingers, 15-1 000 mm, storing of edging sequences possible	3797508



► **Standard control MA**, manual adjustment of bending angle via ring scale on left side of machine



► **Optional control PT 1** - Manual adjustment of bending angle via potentiometer conveniently from the front of the machine



► **Optional control Schneider TM 238**, single-axis control for digital angle input via generously dimensioned touchscreen with the option of storing bending sequences



► **Optional control Schneider CNC2A**, two-axis control for digital angle input and input of the rear stop position with the option of storing bending sequences, motorised rear stop with stop fingers, travel range 15-1 000 mm

Tempering of standard tools on request!

- Tempered acute bending rail and bending rail
- Tempered segmented tools and bending rail
- Tempered segmented crowbar tools and bending rail

Magnetic drilling
Deburring
Metal grinding
Cutting
Notching & punching
Bending
Presses
Circular saws
Roller conveyors
Metal-cutting band saws

Motorised brake bending machines

MSBM PRO – Motorised brake bending machines, heavy-duty type for sheet thicknesses up to 4.0 mm



- ▶ Suitable for sheet thicknesses up to 4.0 mm
- ▶ Foot-operated
- ▶ Heavy, compact welded design
- ▶ Powerful drive thanks to Lenze motors
- ▶ With full-width acute bending rail

- ▶ With manual bending angle adjustment as standard
- ▶ Very low maintenance requirements
- ▶ Motorised workpiece clamping

SH models

- ▶ With high, segmented crowbar tools



MSBM 3020-20 PRO SH
With optional control PT 1

Type	Segmentation MSBM PRO SH
MSBM 1220-40 PRO SH	25-30-35-40-45-50-75-100-150-220-500
MSBM 1520-35 PRO SH	25-30-35-40-45-50-75-100-150-220-250-500
MSBM 2020-30 PRO SH	25-30-35-40-45-50-75-100-150-220-250-500-500
MSBM 2520-25 PRO SH	25-30-35-40-45-50-75-100-150-220-250-500-500-500
MSBM 3020-20 PRO SH	25-30-35-40-45-50-75-100-150-220-250-400-400-500-500

Model in **DUO design** featuring **full-width acute bending rail** and **segmented crowbar tools** available on request

Model	Max. working width	Sheet thickness max.*	Passageway between top + bottom beam max.	Motor output		Weight	Dimensions L x W x H in mm	Art. no.
				Beam	Bending			
MSBM 1220-40 PRO	1 220 mm	4.0 mm	200 mm	0.75 kW	3.0 kW	2 300 kg	2 190 x 1 070 x 1 530	3779119
MSBM 1520-35 PRO	1 520 mm	3.5 mm	200 mm	0.75 kW	3.0 kW	2 700 kg	2 345 x 1 100 x 1 560	3779120
MSBM 2020-30 PRO	2 020 mm	3.0 mm	200 mm	0.75 kW	3.0 kW	3 050 kg	2 935 x 1 100 x 1 560	3779121
MSBM 2520-25 PRO	2 520 mm	2.5 mm	200 mm	0.75 kW	3.0 kW	3 600 kg	3 435 x 1 100 x 1 560	3779122
MSBM 3020-20 PRO	3 020 mm	2.0 mm	200 mm	0.75 kW	3.0 kW	4 300 kg	3 935 x 1 100 x 1 560	3779123
MSBM 1220-40 PRO SH	1 220 mm	4.0 mm	90 mm	0.75 kW	3.0 kW	2 300 kg	2 190 x 1 070 x 1 530	3779129
MSBM 1520-35 PRO SH	1 520 mm	3.5 mm	90 mm	0.75 kW	3.0 kW	2 700 kg	2 345 x 1 100 x 1 560	3779130
MSBM 2020-30 PRO SH	2 020 mm	3.0 mm	90 mm	0.75 kW	3.0 kW	3 050 kg	2 935 x 1 100 x 1 560	3779131
MSBM 2520-25 PRO SH	2 520 mm	2.5 mm	90 mm	0.75 kW	3.0 kW	3 600 kg	3 435 x 1 100 x 1 560	3779132
MSBM 3020-20 PRO SH	3 020 mm	2.0 mm	90 mm	0.75 kW	3.0 kW	4 300 kg	3 935 x 1 100 x 1 560	3779133

*Performance data for material with tensile strength of 400 N/mm²; bending performance stainless steel (VA) = factor 0.75; bending performance aluminium = 1.2; optional tempering of the material is necessary for bending stainless steel (VA)

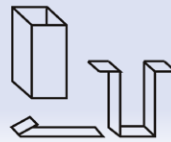
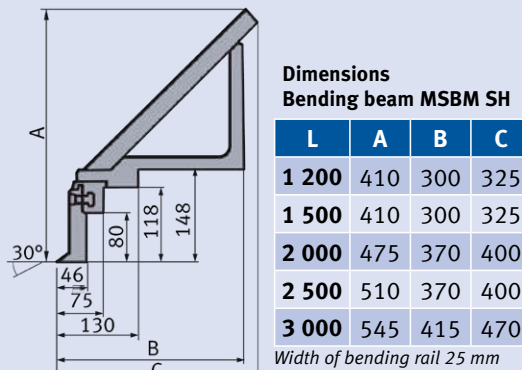
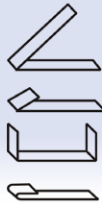
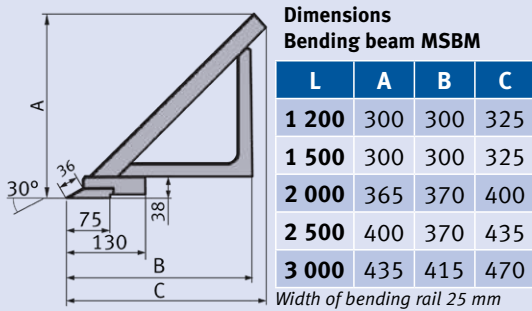

Accessories (all models)

	Art. no.
Control PT 1, bending angle adjustment via potentiometer on face side of machine	3797160
Control Schneider TM 238, bending angle adjustment via touchscreen on NC control, storing of bending sequences possible	3797500

Accessories MSBM 1220-40 PRO / SH

	Art. no.
Rear stop with hand wheel, measuring device and full-width beam, 75 - 760 mm	3797005
Rear stop with hand wheel, measuring device and stop fingers 6 - 760 mm	3797010
Control Schneider CNC2A, bending angle and rear stop adjustment via touchscreen on NC control, motorised rear stop with stop fingers, 15-1 000 mm, storing of edging sequences possible	3797520
Control Schneider CNC3A, bending angle, rear stop and upper beam opening via touchscreen on NC control, motorised rear stop with stop fingers, 15-1 000 mm, storing of bending sequences possible	3797530
CNC control FF101 with 3D graphics, 19" touchscreen, motorised rear stop with stop fingers, 15-1 000 mm,	3797540

Accessories MSBM 1520-35 PRO / SH

	Art. no.
Rear stop with hand wheel, measuring device and full-width beam, 75 - 760 mm	3797010
Rear stop with hand wheel, measuring device and stop fingers 6 - 760 mm	3797020
Control Schneider CNC2A, bending angle and rear stop adjustment via touchscreen on NC control, motorised rear stop with stop fingers, 15-1 000 mm, storing of edging sequences possible	3797521
Control Schneider CNC3A, bending angle, rear stop and upper beam opening via touchscreen on NC control, motorised rear stop with stop fingers, 15-1 000 mm, storing of edging sequences possible	3797531
CNC control FF101 with 3D graphics, 19" touchscreen, motorised rear stop with stop fingers, 15-1 000 mm,	3797541

Accessories MSBM 2020-30 PRO / SH

	Art. no.
Rear stop with hand wheel, measuring device and full-width beam, 75 - 760 mm	3797011

Rear stop with hand wheel, measuring device and stop fingers 6 - 760 mm	3797021
Control Schneider CNC2A, bending angle and rear stop adjustment via touchscreen on NC control, motorised rear stop with stop fingers, 15-1 000 mm, storing of edging sequences possible	3797522
Control Schneider CNC3A, bending angle, rear stop and upper beam opening via touchscreen on NC control, motorised rear stop with stop fingers, 15-1 000 mm, storing of edging sequences possible	3797532
CNC control FF101 with 3D graphics, 19" touchscreen, motorised rear stop with stop fingers, 15-1 000 mm,	3797542

Accessories MSBM 2520-25 PRO / SH

	Art. no.
Rear stop with hand wheel, measuring device and full-width beam, 75 - 760 mm	3797012
Rear stop with hand wheel, measuring device and stop fingers 6 - 760 mm	3797022
Control Schneider CNC2A, bending angle and rear stop adjustment via touchscreen on NC control, motorised rear stop with stop fingers, 15-1 000 mm, storing of edging sequences possible	3797523
Control Schneider CNC3A, bending angle, rear stop and upper beam opening via touchscreen on NC control, motorised rear stop with stop fingers, 15-1 000 mm, storing of edging sequences possible	3797533

Accessories MSBM 3020-20 PRO / SH

	Art. no.
Rear stop with hand wheel, measuring device and full-width beam, 75 - 760 mm	3797013
Rear stop with hand wheel, measuring device and stop fingers 6 - 760 mm	3797023
Control Schneider CNC2A, bending angle and rear stop adjustment via touchscreen on NC control, motorised rear stop with stop fingers, 15-1 000 mm, storing of edging sequences possible	3797524
Control Schneider CNC3A, bending angle, rear stop and upper beam opening via touchscreen on NC control, motorised rear stop with stop fingers, 15-1 000 mm, storing of edging sequences possible	3797534
CNC control FF101 with 3D graphics, 19" touchscreen, motorised rear stop with stop fingers, 15-1 000 mm,	3797544



Option
Optional CNC control with 3D graphics, the profiles are drawn by the operator on a generously dimensioned 19" touchscreen; all axis positions and the bending sequence are computed by the control, motorised rear stop with stop fingers, travel range 15-1 000 mm

Tempering of standard tools on request!

- ▶ Tempered acute bending rail and bending rail
- ▶ Tempered segmented tools and bending rail
- ▶ Tempered segmented crowbar tools and bending rail



Standard control MA - manual adjustment of bending angle via ring scale on left side of machine



Option
Optional control PT 1 - Manual adjustment of bending angle via potentiometer conveniently from the front of the machine



Option
Optional control Schneider TM 238, single-axis control for digital angle input via generously dimensioned touchscreen with the option of storing bending sequences



Option
Optional control Schneider CNC2A, two-axis control for digital angle input and input of the rear stop position with the option of storing bending sequences, motorised rear stop with stop fingers, travel range 15-1 000 mm



Option
Optional control Schneider CNC3A, three-axis control for digital angle input, input of the rear stop position and beam opening position with the option of storing bending sequences, motorised rear stop with stop fingers, travel range 15-1 000 mm

Motorised brake bending machines

MSBM PRO – Motorised brake bending machines, heavy-duty type for sheet thicknesses up to 5.0 mm



- ▶ Suitable for sheet thicknesses up to 5.0 mm
- ▶ Foot-operated
- ▶ Heavy, compact welded design
- ▶ Powerful drive thanks to Lenze motors
- ▶ With full-width acute bending rail

- ▶ With manual bending angle adjustment as standard
- ▶ Very low maintenance requirements
- ▶ Motorised workpiece clamping

SH models

- ▶ With high, segmented crowbar tools



MSBM 3020-30 PRO SH
with optional control PT 1

Type	Segmentation MSBM PRO SH
MSBM 1520-50 PRO SH	25-30-35-40-45-50-75-100-150-220-250-500
MSBM 2020-40 PRO SH	25-30-35-40-45-50-75-100-150-220-250-500
MSBM 2520-35 PRO SH	25-30-35-40-45-50-75-100-150-220-250-500-500
MSBM 3020-30 PRO SH	25-30-35-40-45-50-75-100-150-220-250-500-500-500
MSBM 4020-20 PRO SH	25-30-35-40-45-50-75-100-150-220-250-500-500-500-500-500

Model in **DUO design** featuring full-width acute bending rail and segmented crowbar tools available on request

Model	Max. working width	Sheet thickness max.*	Passageway between top + bottom beam max.	Motor output		Weight	Dimensions L x W x H in mm	Art. no.
				Beam	Bending			
MSBM 1520-50 PRO	1 520 mm	5.0 mm	200 mm	1.1 kW	4.0 kW	3 250 kg	2 345 x 1 100 x 1 560	3779128
MSBM 2020-40 PRO	2 020 mm	4.0 mm	200 mm	1.1 kW	4.0 kW	3 900 kg	3 020 x 1 100 x 1 560	3779124
MSBM 2520-35 PRO	2 520 mm	3.5 mm	200 mm	1.1 kW	4.0 kW	4 500 kg	3 620 x 1 100 x 1 560	3779125
MSBM 3020-30 PRO	3 020 mm	3.0 mm	200 mm	1.1 kW	4.0 kW	6 200 kg	4 020 x 1 100 x 1 560	3779126
MSBM 4020-20 PRO	4 020 mm	2.0 mm	90 mm	1.1 kW	4.0 kW	7 000 kg	5 200 x 1 100 x 1 560	3779127
MSBM 1520-50 PRO SH	1 520 mm	5.0 mm	200 mm	1.1 kW	4.0 kW	3 400 kg	2 345 x 1 100 x 1 560	3779138
MSBM 2020-40 PRO SH	2 020 mm	4.0 mm	90 mm	1.1 kW	4.0 kW	3 900 kg	3 020 x 1 100 x 1 560	3779134
MSBM 2520-35 PRO SH	2 520 mm	3.5 mm	90 mm	1.1 kW	4.0 kW	4 500 kg	3 620 x 1 100 x 1 560	3779135
MSBM 3020-30 PRO SH	3 020 mm	3.0 mm	90 mm	1.1 kW	4.0 kW	6 200 kg	4 020 x 1 100 x 1 560	3779136
MSBM 4020-20 PRO SH	4 020 mm	2.0 mm	90 mm	1.1 kW	4.0 kW	7 250 kg	5 200 x 1 100 x 1 560	3779139

*Performance data for material with tensile strength of 400 N/mm²; bending performance stainless steel (VA) = factor 0.75; bending performance aluminium = 1.2; optional tempering of the material is necessary for bending stainless steel (VA);

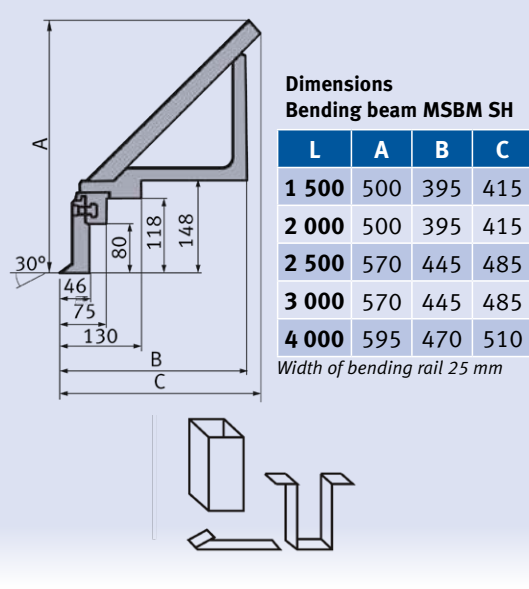
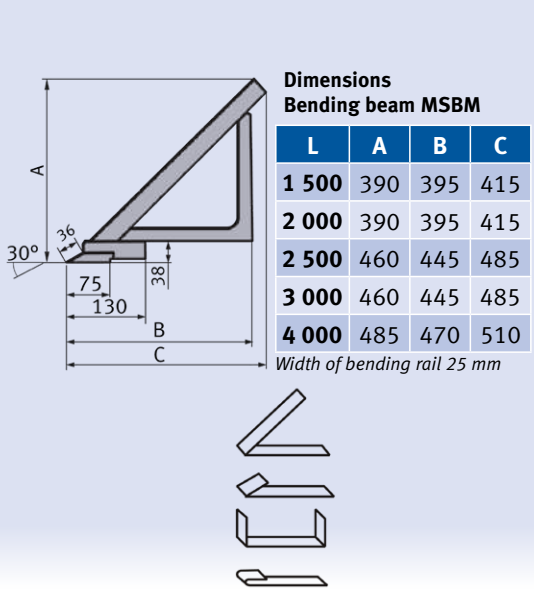

► **Standard control MA** - manual adjustment of bending angle via ring scale on left side of machine



Option
► **Optional control PT 1** - Manual adjustment of bending angle via potentiometer conveniently from the front of the machine



Option
► **Optional control Schneider TM 238**, single-axis control for digital angle input via generously dimensioned touchscreen with the option of storing bending sequences



Option
► **Optional control Schneider CNC2A**, two-axis control for digital angle input and input of the rear stop position with the option of storing bending sequences, motorised rear stop with stop fingers, travel range 15-1 000 mm



Option
► **Optional control Schneider CNC3A**, three-axis control for digital angle input, input of the rear stop position and beam opening position with the option of storing bending sequences, motorised rear stop with stop fingers, travel range 15-1 000 mm

Accessories (all models)	Art. no.
Control PT 1, bending angle adjustment via potentiometer on face side of machine	3797160
Control Schneider TM 238, bending angle adjustment via touchscreen on NC control, storing of bending sequences possible	3797500

Accessories MSBM 1520-50 PRO / SH	Art. no.
Rear stop with hand wheel, measuring device and full-width beam, 75 - 760 mm	3797010
Rear stop with hand wheel, measuring device and stop fingers 6 - 760 mm	3797020
Control Schneider CNC2A, bending angle and rear stop adjustment via touchscreen on NC control, motorised rear stop with stop fingers, 15-1 000 mm, storing of edging sequences possible	3797550
Control Schneider CNC3A, bending angle, rear stop and upper beam opening via touchscreen on NC control, motorised rear stop with stop fingers, 15-1 000 mm, storing of bending sequences possible	3797560
CNC control FF101 with 3D graphics, 19" touchscreen, motorised rear stop with stop fingers, 15-1 000 mm,	3797570

Accessories MSBM 2020-40 PRO / SH	Art. no.
Rear stop with hand wheel, measuring device and full-width beam, 75 - 760 mm	3797011
Rear stop with hand wheel, measuring device and stop fingers 6 - 760 mm	3797021
Control PT 1, bending angle adjustment via potentiometer on face side of machine	3797160
Control Schneider TM 238, bending angle adjustment via touchscreen on NC control, storing of bending sequences possible	3797500
Control Schneider CNC2A, bending angle and rear stop adjustment via touchscreen on NC control, motorised rear stop with stop fingers, 15-1 000 mm, storing of edging sequences possible	3797551
Control Schneider CNC3A, bending angle, rear stop and upper beam opening via touchscreen on NC control, motorised rear stop with stop fingers, 15-1 000 mm, storing of bending sequences possible	3797561
CNC control FF101 with 3D graphics, 19" touchscreen, motorised rear stop with stop fingers, 15-1 000 mm,	3797571



Option
► **Optional CNC control with 3D graphics**, the profiles are drawn by the operator on a generously dimensioned 19" touchscreen; all axis positions and the bending sequence are computed by the control, motorised rear stop with stop fingers, travel range 15-1 000 mm

Accessories MSBM 2520-35 PRO / SH	Art. no.
Rear stop with hand wheel, measuring device and full-width beam, 75 - 760 mm	3797012
Rear stop with hand wheel, measuring device and stop fingers 6 - 760 mm	3797022
Control Schneider CNC2A, bending angle and rear stop adjustment via touchscreen on NC control, motorised rear stop with stop fingers, 15-1 000 mm, storing of edging sequences possible	3797552
Control Schneider CNC3A, bending angle, rear stop and upper beam opening via touchscreen on NC control, motorised rear stop with stop fingers, 15-1 000 mm, storing of bending sequences possible	3797562
CNC control FF101 with 3D graphics, 19" touchscreen, motorised rear stop with stop fingers, 15-1 000 mm,	3797572

Accessories MSBM 3020-30 PRO / SH	Art. no.
Rear stop with hand wheel, measuring device and full-width beam, 75 - 760 mm	3797013
Rear stop with hand wheel, measuring device and stop fingers 6 - 760 mm	3797023
Control Schneider CNC2A, bending angle and rear stop adjustment via touchscreen on NC control, motorised rear stop with stop fingers, 15-1 000 mm, storing of edging sequences possible	3797553
Control Schneider CNC3A, bending angle, rear stop and upper beam opening via touchscreen on NC control, motorised rear stop with stop fingers, 15-1 000 mm, storing of bending sequences possible	3797563
CNC control FF101 with 3D graphics, 19" touchscreen, motorised rear stop with stop fingers, 15-1 000 mm,	3797573

Accessories MSBM 4020-20 PRO / SH	Art. no.
Rear stop with hand wheel, measuring device and full-width beam, 75 - 760 mm	3797014
Rear stop with hand wheel, measuring device and stop fingers 6 - 760 mm	3797024
Control Schneider CNC2A, bending angle and rear stop adjustment via touchscreen on NC control, motorised rear stop with stop fingers, 15-1 000 mm, storing of edging sequences possible	3797554
Control Schneider CNC3A, bending angle, rear stop and upper beam opening via touchscreen on NC control, motorised rear stop with stop fingers, 15-1 000 mm, storing of edging sequences possible	3797564
CNC control FF101 with 3D graphics, 19" touchscreen, motorised rear stop with stop fingers, 15-1 000 mm,	3797574

Accessories MSBM 4020-20 PRO / SH	Art. no.
Rear stop with hand wheel, measuring device and full-width beam, 75 - 760 mm	3797014
Rear stop with hand wheel, measuring device and stop fingers 6 - 760 mm	3797024
Control Schneider CNC2A, bending angle and rear stop adjustment via touchscreen on NC control, motorised rear stop with stop fingers, 15-1 000 mm, storing of edging sequences possible	3797554
Control Schneider CNC3A, bending angle, rear stop and upper beam opening via touchscreen on NC control, motorised rear stop with stop fingers, 15-1 000 mm, storing of edging sequences possible	3797564
CNC control FF101 with 3D graphics, 19" touchscreen, motorised rear stop with stop fingers, 15-1 000 mm,	3797574

Tempering of standard tools on request!

- Tempered acute bending rail and bending rail
- Tempered segmented tools and bending rail
- Tempered segmented crowbar tools and bending rail

Motorised brake bending machines

MSBM PRO – Motorised brake bending machines, heavy-duty type for sheet thickness up to 7.0 mm



- ▶ Suitable for sheet thicknesses up to 7.0 mm
- ▶ Foot-operated
- ▶ Heavy, compact welded design
- ▶ Powerful drive thanks to Lenze motors
- ▶ With full-width acute bending rail

- ▶ With manual bending angle adjustment as standard
- ▶ Very low maintenance requirements
- ▶ Motorised workpiece clamping

SH models

- ▶ With high, segmented crowbar tools

DUO models

- ▶ Featuring full-width acute bending rail and high segmented crowbar tools



MSBM 2020-60 PRO SH with optional control TM 238

Type	Segmentation MSBM PRO SH
MSBM 1520-70 PRO SH	25-30-35-40-45-50-75-100-150-220-250-500
MSBM 2020-60 PRO SH	25-30-35-40-45-50-75-100-150-220-250-500-500
MSBM 2520-50 PRO SH	25-30-35-40-45-50-75-100-150-220-250-500-500-500
MSBM 3020-40 PRO SH	25-30-35-40-45-50-75-100-150-220-250-500-500-500-500
MSBM 4020-20 PRO SH	25-30-35-40-45-50-75-100-150-220-250-500-500-500-500-500

Model	Max. working width	Sheet thickness max.*	Passageway between top + bottom beam max.	Motor output		Weight	Dimensions L x W x H in mm	Art. no.
				Beam	Bending			
MSBM 1520-70 PRO	1 520 mm	7.0 mm	200 mm	2.2 kW	5.5 kW	4025 kg	2620 x 1160 x 1 590	3779140
MSBM 2020-60 PRO	2 020 mm	6.0 mm	200 mm	2.2 kW	5.5 kW	4650 kg	3120 x 1160 x 1 590	3779141
MSBM 2520-50 PRO	2 520 mm	5.0 mm	200 mm	2.2 kW	5.5 kW	5270 kg	3620 x 1160 x 1 590	3779142
MSBM 3020-40 PRO	3 020 mm	4.0 mm	200 mm	2.2 kW	5.5 kW	6090 kg	4120 x 1160 x 1 590	3779143
MSBM 4020-30 PRO	4 020 mm	3.0 mm	200 mm	2.2 kW	5.5 kW	7460 kg	5120 x 1160 x 1 590	3779144
MSBM 1520-70 PRO SH	1 520 mm	7.0 mm	90 mm	2.2 kW	5.5 kW	4025 kg	2620 x 1160 x 1 590	3779150
MSBM 2020-60 PRO SH	2 020 mm	6.0 mm	90 mm	2.2 kW	5.5 kW	4650 kg	3120 x 1160 x 1 590	3779151
MSBM 2520-50 PRO SH	2 520 mm	5.0 mm	90 mm	2.2 kW	5.5 kW	5270 kg	3620 x 1160 x 1 590	3779152
MSBM 3020-40 PRO SH	3 020 mm	4.0 mm	90 mm	2.2 kW	5.5 kW	6090 kg	4120 x 1160 x 1 590	3779153
MSBM 4020-30 PRO SH	4 020 mm	3.0 mm	90 mm	2.2 kW	5.5 kW	7460 kg	5120 x 1160 x 1 590	3779154
MSBM 1520-70 PRO DUO	1 520 mm	7.0 mm	90/200 mm	2.2 kW	5.5 kW	4025 kg	2620 x 1160 x 1 590	3779220
MSBM 2020-60 PRO DUO	2 020 mm	6.0 mm	90/200 mm	2.2 kW	5.5 kW	4650 kg	3120 x 1160 x 1 590	3779221
MSBM 2520-50 PRO DUO	2 520 mm	5.0 mm	90/200 mm	2.2 kW	5.5 kW	5270 kg	3620 x 1160 x 1 590	3779222
MSBM 3020-40 PRO DUO	3 020 mm	4.0 mm	90/200 mm	2.2 kW	5.5 kW	6090 kg	4120 x 1160 x 1 590	3779223
MSBM 4020-30 PRO DUO	4 020 mm	3.0 mm	90/200 mm	2.2 kW	5.5 kW	7460 kg	5120 x 1160 x 1 590	3779224

*Performance data for material with tensile strength of 400 N/mm²; bending performance stainless steel (VA) = factor 0.75; bending performance aluminium = 1.2; optional tempering of the material is necessary for bending stainless steel (VA);

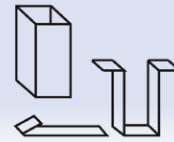
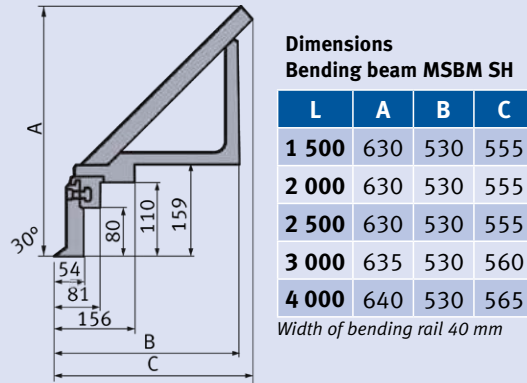
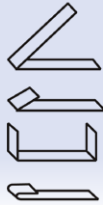
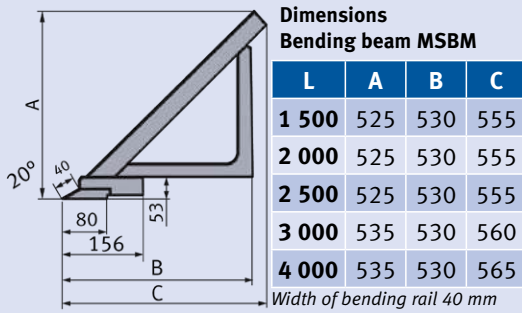

► **Standard control MA** - manual adjustment of bending angle via ring scale on left side of machine



► **Optional control PT 1** - Manual adjustment of bending angle via potentiometer conveniently from the front of the machine



► **Optional control Schneider TM 238**, single-axis control for digital angle input via generously dimensioned touchscreen with the option of storing bending sequences



► **Optional control Schneider CNC2A**, two-axis control for digital angle input and input of the rear stop position with the option of storing bending sequences, motorised rear stop with stop fingers, travel range 15-1 000 mm



► **Optional control Schneider CNC3A**, three-axis control for digital angle input, input of the rear stop position and beam opening position with the option of storing bending sequences, motorised rear stop with stop fingers, travel range 15-1 000 mm

Accessories (all models)

Art. no.
Control PT 1, bending angle adjustment via potentiometer on face side of machine
3797160
Control Schneider TM 238, bending angle adjustment via touchscreen on NC control, storing of bending sequences possible
3797500

Accessories MSBM 1520-70 PRO / SH / DUO

Art. no.
Rear stop with hand wheel, measuring device and full-width beam, 75 - 760 mm
3797010
Rear stop with hand wheel, measuring device and stop fingers 6 - 760 mm
3797020
Control Schneider CNC2A, bending angle and rear stop adjustment via touchscreen on NC control, motorised rear stop with stop fingers, 15-1 000 mm, storing of edging sequences possible
3797590
Control Schneider CNC3A, bending angle, rear stop and upper beam opening via touchscreen on NC control, motorised rear stop with stop fingers, 15-1 000 mm, storing of bending sequences possible
3797610
CNC control FF101 with 3D graphics, 19" touchscreen, motorised rear stop with stop fingers, 15-1 000 mm,
3797620

Accessories MSBM 2020-60 PRO / SH / DUO

Art. no.
Rear stop with hand wheel, measuring device and full-width beam, 75 - 760 mm
3797011
Rear stop with hand wheel, measuring device and stop fingers 6 - 760 mm
3797021
Control Schneider CNC2A, bending angle and rear stop adjustment via touchscreen on NC control, motorised rear stop with stop fingers, 15-1 000 mm, storing of edging sequences possible
3797591
Control Schneider CNC3A, bending angle, rear stop and upper beam opening via touchscreen on NC control, motorised rear stop with stop fingers, 15-1 000 mm, storing of bending sequences possible
3797611
CNC control FF101 with 3D graphics, 19" touchscreen, motorised rear stop with stop fingers, 15-1 000 mm,
3797621

Accessories MSBM 2520-50 PRO / SH / DUO

Art. no.
Rear stop with hand wheel, measuring device and full-width beam, 75 - 760 mm
3797012
Rear stop with hand wheel, measuring device and stop fingers 6 - 760 mm
3797022
Control Schneider CNC2A, bending angle and rear stop adjustment via touchscreen on NC control, motorised rear stop with stop fingers, 15-1 000 mm, storing of edging sequences possible
3797592
Control Schneider CNC3A, bending angle, rear stop and upper beam opening via touchscreen on NC control, motorised rear stop with stop fingers, 15-1 000 mm, storing of bending sequences possible
3797612
CNC control FF101 with 3D graphics, 19" touchscreen, motorised rear stop with stop fingers, 15-1 000 mm,
3797622
Tempering of standard tools for MSBM 2520-50 PRO, tempered acute bending rail, bending rail and support bed
3799132

Rear stop with hand wheel, measuring device and full-width beam, 75 - 760 mm

Rear stop with hand wheel, measuring device and stop fingers 6 - 760 mm

Control Schneider CNC2A, bending angle and rear stop adjustment via touchscreen on NC control, motorised rear stop with stop fingers, 15-1 000 mm, storing of edging sequences possible

Control Schneider CNC3A, bending angle, rear stop and upper beam opening via touchscreen on NC control, motorised rear stop with stop fingers, 15-1 000 mm, storing of bending sequences possible

CNC control FF101 with 3D graphics, 19" touchscreen, motorised rear stop with stop fingers, 15-1 000 mm,

Tempering of standard tools for MSBM 2520-50 PRO, tempered acute bending rail, bending rail and support bed

Accessories MSBM 3020-40 PRO / SH / DUO

Art. no.
Rear stop with hand wheel, measuring device and full-width beam, 75 - 760 mm
3797013
Rear stop with hand wheel, measuring device and stop fingers 6 - 760 mm
3797023
Control Schneider CNC2A, bending angle and rear stop adjustment via touchscreen on NC control, motorised rear stop with stop fingers, 15-1 000 mm, storing of edging sequences possible
3797593
Control Schneider CNC3A, bending angle, rear stop and upper beam opening via touchscreen on NC control, motorised rear stop with stop fingers, 15-1 000 mm, storing of bending sequences possible
3797613
CNC control FF101 with 3D graphics, 19" touchscreen, motorised rear stop with stop fingers, 15-1 000 mm,
3797623
Tempering of standard tools for MSBM 3020-40 PRO, tempered acute bending rail, bending rail and support bed
3799133

Accessories MSBM 4020-30 PRO / SH / DUO

Art. no.
Rear stop with hand wheel, measuring device and full-width beam, 75 - 760 mm
3797014
Rear stop with hand wheel, measuring device and stop fingers 6 - 760 mm
3797024
Control Schneider CNC2A, bending angle and rear stop adjustment via touchscreen on NC control, motorised rear stop with stop fingers, 15-1 000 mm, storing of edging sequences possible
3797594
Control Schneider CNC3A, bending angle, rear stop and upper beam opening via touchscreen on NC control, motorised rear stop with stop fingers, 15-1 000 mm, storing of bending sequences possible
3797614
CNC control FF101 with 3D graphics, 19" touchscreen, motorised rear stop with stop fingers, 15-1 000 mm,
3797624



► **Optional CNC control with 3D graphics**, the profiles are drawn by the operator on a generously dimensioned 19" touchscreen; all axis positions and the bending sequence are computed by the control, motorised rear stop with stop fingers, travel range 15-1 000 mm

Tempering of standard tools on request!

- Tempered acute bending rail and bending rail
- Tempered segmented tools and bending rail
- Tempered segmented crowbar tools and bending rail

Motorised brake bending machines

MSBM PRO – Motorised brake bending machines, ultra-heavy-duty type for sheet thicknesses up to 8.0 mm



- ▶ Suitable for sheet thicknesses up to 8 mm
- ▶ Very heavy-duty and durable welded structure
- ▶ Dynamically driven bending beam through two frequency-controlled gear motors
- ▶ Top beam clamping via trapezoid thread
- ▶ Premium Lenze motors
- ▶ Full-width acute bending rail

- ▶ Tools suitable for bending stainless steel
- ▶ Bending angle adjustment via touchscreen NC control
- ▶ Sheet thickness setting manually on the bending beam
- ▶ Manual crowing device on bending beam
- ▶ Operated via double foot pedal with emergency stop function
- ▶ All-motorised machine without hydraulics

SH models

- ▶ With high, segmented crowbar tools

DUO models

- ▶ Featuring full-width acute bending rail and high segmented crowbar tools



MSBM 2020-80 PRO

Type	Segmentation MSBM PRO SH
MSBM 2020-80 PRO SH	25-30-35-40-45-50-75-100-150-220-250-500-500
MSBM 2520-70 PRO SH	25-30-35-40-45-50-75-100-150-220-250-500-500-500
MSBM 3020-60 PRO SH	25-30-35-40-45-50-75-100-150-220-250-500-500-500-500
MSBM 4020-40 PRO SH	25-30-35-40-45-50-75-100-150-220-250-500-500-500-500-500
MSBM 4520-30 PRO SH	25-30-35-40-45-50-75-100-150-220-250-500-500-500-500-500-500
MSBM 5020-20 PRO SH	25-30-35-40-45-50-75-100-150-220-250-500-500-500-500-500-500-500

Model	Max. working width	Sheet thickness max.*	Passageway between top + bottom beam max.	Motor output		Weight	Dimensions L x W x H in mm	Art. no.
				Beam	Bending			
MSBM 2020-80 PRO	2 020 mm	8.0 mm	350 mm	4.0 kW	2 x 4.0 kW	5 380 kg	3 480 x 1 500 x 1 750	3779400
MSBM 2520-70 PRO	2 520 mm	7.0 mm	350 mm	4.0 kW	2 x 4.0 kW	5 900 kg	3 970 x 1 500 x 1 750	3779401
MSBM 3020-60 PRO	3 020 mm	6.0 mm	350 mm	4.0 kW	2 x 4.0 kW	6 550 kg	4 470 x 1 500 x 1 750	3779402
MSBM 4020-40 PRO	4 020 mm	4.0 mm	350 mm	4.0 kW	2 x 4.0 kW	8 130 kg	5 480 x 1 500 x 1 750	3779403
MSBM 4520-30 PRO	4 520 mm	3.0 mm	350 mm	4.0 kW	2 x 4.0 kW	8 980 kg	5 980 x 1 500 x 1 750	3779404
MSBM 5020-20 PRO	5 020 mm	2.0 mm	350 mm	4.0 kW	2 x 4.0 kW	9 840 kg	6 480 x 1 500 x 1 750	3779405
MSBM 2020-80 PRO SH	2 020 mm	8.0 mm	240 mm	4.0 kW	2 x 4.0 kW	5 380 kg	3 480 x 1 500 x 1 750	3779410
MSBM 2520-70 PRO SH	2 520 mm	7.0 mm	240 mm	4.0 kW	2 x 4.0 kW	5 900 kg	3 970 x 1 500 x 1 750	3779411
MSBM 3020-60 PRO SH	3 020 mm	6.0 mm	240 mm	4.0 kW	2 x 4.0 kW	6 550 kg	4 470 x 1 500 x 1 750	3779412
MSBM 4020-40 PRO SH	4 020 mm	4.0 mm	240 mm	4.0 kW	2 x 4.0 kW	8 130 kg	5 480 x 1 500 x 1 750	3779413
MSBM 4520-30 PRO SH	4 520 mm	3.0 mm	240 mm	4.0 kW	2 x 4.0 kW	8 980 kg	5 980 x 1 500 x 1 750	3779414
MSBM 5020-20 PRO SH	5 020 mm	2.0 mm	240 mm	4.0 kW	2 x 4.0 kW	9 840 kg	6 480 x 1 500 x 1 750	3779415
MSBM 2020-80 PRO DUO	2 020 mm	8.0 mm	350/240 mm	4.0 kW	2 x 4.0 kW	5 380 kg	3 480 x 1 500 x 1 750	3779420
MSBM 2520-70 PRO DUO	2 520 mm	7.0 mm	350/240 mm	4.0 kW	2 x 4.0 kW	5 900 kg	3 970 x 1 500 x 1 750	3779421
MSBM 3020-60 PRO DUO	3 020 mm	6.0 mm	350/240 mm	4.0 kW	2 x 4.0 kW	6 550 kg	4 470 x 1 500 x 1 750	3779422
MSBM 4020-40 PRO DUO	4 020 mm	4.0 mm	350/240 mm	4.0 kW	2 x 4.0 kW	8 130 kg	5 480 x 1 500 x 1 750	3779423
MSBM 4520-30 PRO DUO	4 520 mm	3.0 mm	350/240 mm	4.0 kW	2 x 4.0 kW	8 980 kg	5 980 x 1 500 x 1 750	3779424
MSBM 5020-20 PRO DUO	5 020 mm	2.0 mm	350/240 mm	4.0 kW	2 x 4.0 kW	9 840 kg	6 480 x 1 500 x 1 750	3779425

*Performance data for material with tensile strength of 400 N/mm²; bending performance stainless steel (VA) = factor 0.75; bending performance aluminium = 1.2; optional tempering of the material is necessary for bending stainless steel (VA)

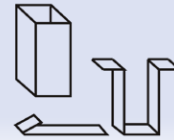
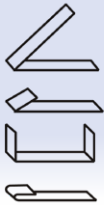
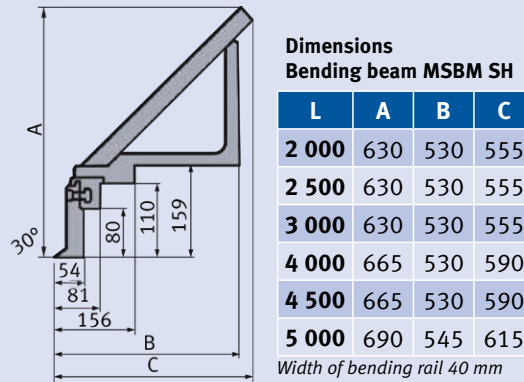
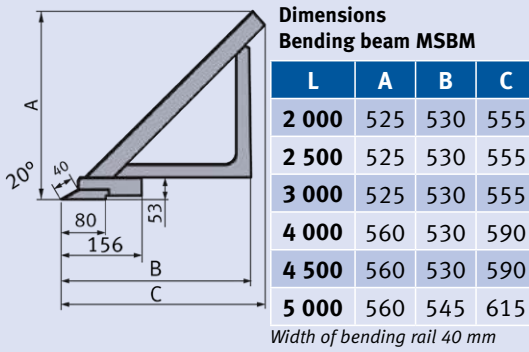

Accessories MSBM 2020-80 PRO / SH / DUO	Art. no.
Rear stop with hand wheel, measuring device and full-width beam, 75 - 760 mm	3797011
Rear stop with hand wheel, measuring device and stop fingers 6 - 760 mm	3797021
Control Schneider CNC2A, bending angle and rear stop adjustment via touchscreen on NC control, motorised rear stop with stop fingers, 15-1 000 mm, storing of edging sequences possible	3797591
Control Schneider CNC3A, bending angle, rear stop and upper beam opening via touchscreen on NC control, motorised rear stop with stop fingers, 15-1 000 mm, storing of bending sequences possible	3797611
CNC control FF101 with 3D graphics, 19" touchscreen, motorised rear stop with stop fingers, 15-1 000 mm,	3797621
Accessories MSBM 2520-70 PRO / SH / DUO	Art. no.
Rear stop with hand wheel, measuring device and full-width beam, 75 - 760 mm	3797012
Rear stop with hand wheel, measuring device and stop fingers 6 - 760 mm	3797022
Control Schneider CNC2A, bending angle and rear stop adjustment via touchscreen on NC control, motorised rear stop with stop fingers, 15-1 000 mm, storing of edging sequences possible	3797592
Control Schneider CNC3A, bending angle, rear stop and upper beam opening via touchscreen on NC control, motorised rear stop with stop fingers, 15-1 000 mm, storing of bending sequences possible	3797612
CNC control FF101 with 3D graphics, 19" touchscreen, motorised rear stop with stop fingers, 15-1 000 mm,	3797622
Accessories MSBM 3020-60 PRO / SH / DUO	Art. no.
Rear stop with hand wheel, measuring device and full-width beam, 75 - 760 mm	3797013
Rear stop with hand wheel, measuring device and stop fingers 6 - 760 mm	3797023
Control Schneider CNC2A, bending angle and rear stop adjustment via touchscreen on NC control, motorised rear stop with stop fingers, 15-1 000 mm, storing of edging sequences possible	3797593
Control Schneider CNC3A, bending angle, rear stop and upper beam opening via touchscreen on NC control, motorised rear stop with stop fingers, 15-1 000 mm, storing of bending sequences possible	3797613
CNC control FF101 with 3D graphics, 19" touchscreen, motorised rear stop with stop fingers, 15-1 000 mm,	3797623
Accessories MSBM 4020-40 PRO / SH / DUO	Art. no.

Rear stop with hand wheel, measuring device and full-width beam, 75 - 760 mm	3797014
Rear stop with hand wheel, measuring device and stop fingers 6 - 760 mm	3797024
Control Schneider CNC2A, bending angle and rear stop adjustment via touchscreen on NC control, motorised rear stop with stop fingers, 15-1 000 mm, storing of edging sequences possible	3797594
Control Schneider CNC3A, bending angle, rear stop and upper beam opening via touchscreen on NC control, motorised rear stop with stop fingers, 15-1 000 mm, storing of bending sequences possible	3797614
CNC control FF101 with 3D graphics, 19" touchscreen, motorised rear stop with stop fingers, 15-1 000 mm,	3797624
Accessories MSBM 4520-30 PRO / SH / DUO	Art. no.
Rear stop with hand wheel, measuring device and full-width beam, 75 - 760 mm	3797015
Rear stop with hand wheel, measuring device and stop fingers 6 - 760 mm	3797025
Control Schneider CNC2A, bending angle and rear stop adjustment via touchscreen on NC control, motorised rear stop with stop fingers, 15-1 000 mm, storing of edging sequences possible	3797595
Control Schneider CNC3A, bending angle, rear stop and upper beam opening via touchscreen on NC control, motorised rear stop with stop fingers, 15-1 000 mm, storing of bending sequences possible	3797615
CNC control FF101 with 3D graphics, 19" touchscreen, motorised rear stop with stop fingers, 15-1 000 mm,	3797625
Accessories MSBM 5020-20 PRO / SH / DUO	Art. no.
Rear stop with hand wheel, measuring device and full-width beam, 75 - 760 mm	3797016
Rear stop with hand wheel, measuring device and stop fingers 6 - 760 mm	3797026
Control Schneider CNC2A, bending angle and rear stop adjustment via touchscreen on NC control, motorised rear stop with stop fingers, 15-1 000 mm, storing of edging sequences possible	3797596
Control Schneider CNC3A, bending angle, rear stop and upper beam opening via touchscreen on NC control, motorised rear stop with stop fingers, 15-1 000 mm, storing of bending sequences possible	3797616
CNC control FF101 with 3D graphics, 19" touchscreen, motorised rear stop with stop fingers, 15-1 000 mm,	3797626



► **Optional CNC control with 3D graphics**, the profiles are drawn by the operator on a generously dimensioned 19" touchscreen; all axis positions and the bending sequence are computed by the control, motorised rear stop with stop fingers, travel range 15-1 000 mm



► **Standard control MA** manual adjustment of bending angle via ring scale on left side of machine



► **Optional control PT 1** - Manual adjustment of bending angle via potentiometer conveniently from the front of the machine



► **Optional control Schneider TM 238**, single-axis control for digital angle input via generously dimensioned touchscreen with the option of storing bending sequences



► **Optional control Schneider CNC2A**, two-axis control for digital angle input and input of the rear stop position with the option of storing bending sequences, motorised rear stop with stop fingers, travel range 15-1 000 mm



► **Optional control Schneider CNC3A**, three-axis control for digital angle input, input of the rear stop position and beam opening position with the option of storing bending sequences, motorised rear stop with stop fingers, travel range 15-1 000 mm

Bending brakes

GBP-E — CNC controlled press brake with 3-axle drive up to 200 t compression force

Standard type

- ▶ Heavy, welded steel construction, stress-free annealing
- ▶ Graphical 2D CNC control DT-10 with generously-dimensioned 10" touchscreen, ergonomically mounted on swivel arm
- ▶ CNC-controlled Y1, Y2 and X axis
- ▶ X axis driven via play-free ball screws
- ▶ Slightly offset top tool and Multi-V die 85°
- ▶ 2 rear stop fingers guided in longitudinal direction on linear rail
- ▶ Manual R axis, height adjustment of rear stop fingers via hand wheels
- ▶ Positioning of top beam with a resolution of 0.01 mm
- ▶ Measuring system decoupled from side stands to compensate for side stand deflection
- ▶ Manual table crowning via hand wheel with counter
- ▶ Solid, low-maintenance guides on the top beam
- ▶ Long throat
- ▶ 2 sheet support arms with T groove and tilting cams
- ▶ Fliessler AKAS II safety device travels with the top beam
- ▶ Fliessler FPSC safety PLC



GBP-E 3050-120

Model	Press force	Bending length (A)	Upright passageway (B)	Rapid traverse	Bending speed	Retraction	Installation height (D)	Motor output
GBP-E 2550-60	60 t	2 550	2150	120 mm/s	9 mm/s	70 mm/s	350 mm	7.5 kW
GBP-E 3050-120	120 t	3 050	2 550	100 mm/s	9 mm/s	77 mm/s	375 mm	11 kW
GBP-E 3050-200	200 t	3 050	2 550	100 mm/s	7 mm/s	73 mm/s	445 mm	15 kW

Model	Stroke (C)	Reach (E)	Rear stop	Table height (F)	Table width (G)	Number of support brackets	Weight	Dimensions (L x W x H) in mm	Art. no.
GBP-E 2550-60	160 mm	250 mm	620 mm	813 mm	104 mm	2 units	4 000 kg	3 750 x 1 100 x 2 350 mm	3828001
GBP-E 3050-120	180 mm	250 mm	620 mm	878 mm	104 mm	2 units	5 900 kg	4 200 x 1 230 x 2 400 mm	3828002
GBP-E 3050-200	210 mm	250 mm	620 mm	858 mm	104 mm	2 units	7950 kg	4 500 x 1390 x 2 520 mm	3828003

- ▶ Premium hydraulic components (Bosch/Rexroth, Hydac, Atos)
- ▶ Easy operation via mobile foot pedal console with emergency stop
- ▶ Electronically monitored side and rear doors
- ▶ Hydraulic operation

Custom accessories

- ▶ Additional rear stop fingers
- ▶ Additional support arm
- ▶ Manual top tool quick release with cam lever



CNC control DT-10 (standard)

The products are drawn on the graphical 2D control, DT-10 with touchscreen – after completing the drawing, the control computes the bending sequences and the matching axis positions

- ▶ Y1, Y2 and X axes and the optional R axis with motorised crowning are supported
- ▶ 10.1" TFT LCD screen with capacitive touch surface
- ▶ Computation of the following functions: bending sequence, stretched length, immersion depth, changeover point, clamping point, compression force, crowning
- ▶ Bending tools, top beam, table and stop fingers can be freely drawn for optimum collision monitoring
- ▶ Bending sequence simulation
- ▶ USB interface for backing up data

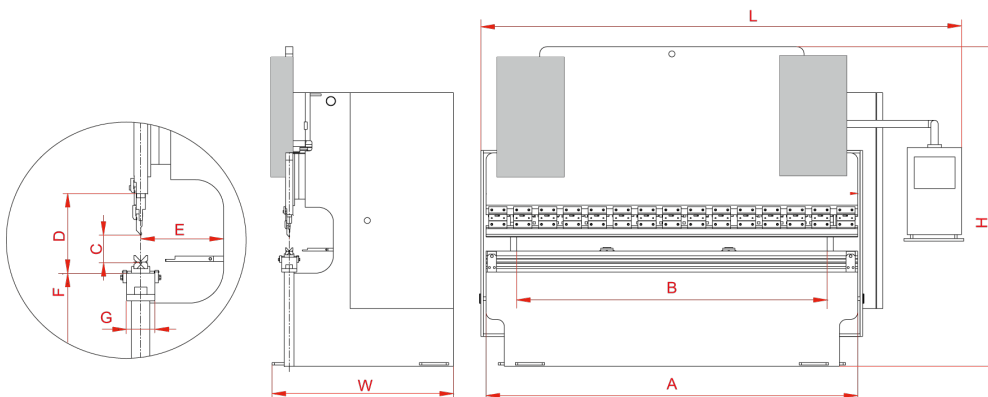

▶ Motorised X axis



▶ Rear stop fingers on linear guide adjustable laterally and height adjustable via spindles



▶ Laterally adjustable support arms with 2 fastening positions



▶ Manual top tool quick release with cam lever (option)

Accessories available on request

- ▶ Additional rear stop fingers
- ▶ Additional sheet support arm
- ▶ Manual top tool quick release

Bending brakes

GBP-R — CNC controlled press brake with 3-axle drive up to 400 t compression force

Standard type

- ▶ Very heavy, rugged welded steel construction, stress-free annealing
- ▶ Graphical 2D CNC control DT-10 with generously-dimensioned 10" touchscreen, ergonomically mounted on swivel arm
- ▶ CNC-controlled Y1, Y2 and X axis
- ▶ X axis 650 mm, guided on linear rails and driven via play-free ball screws (as of GBP-R 4050-400 X axis 750 mm)
- ▶ Two rear stop fingers with double linear guides and generously dimensioned, very rugged aluminium profile
- ▶ Manual R axis, height adjustment of rear stop fingers via hand wheels
- ▶ All rear stop exes, standard and optional, with servo drives
- ▶ Positioning of top beam with a resolution of 0.01 mm
- ▶ Measuring system decoupled from side stands to compensate for side stand deflection
- ▶ Manual table crowning via hand wheel with counter
- ▶ Manual top tool quick release with cam lever and Promecam/Amada system
- ▶ Complete set of Rehfuß top tools
- ▶ Complete set 4x die with V openings 16, 22, 35, 50 mm
- ▶ Solid, low-maintenance quadruple guides on the top beam
- ▶ Large side upright overhang of 410 mm (510 mm for machines of 400 t compression force)
- ▶ 2 sheet support arms with T groove and tilting cams, guided on linear rail in longitudinal direction
- ▶ Fiessler AKAS II safety device travels with the top beam
- ▶ Fiessler FPSC safety PLC
- ▶ Premium hydraulic components (Bosch/Rexroth, Hydac, Atos)
- ▶ Easy operation via mobile foot pedal console with emergency stop
- ▶ Electronically monitored side and rear doors
- ▶ Motorised table crowning, CNC-controlled R axis, CNC-controlled Z1-Z2 axes and alternative CNC-controls optionally available



GBP-R 3050-100 - Figure shows optional motorised table crowning and motorised R axis

Custom accessories

- ▶ Numeric CNC control Cybeclec ModEva 15T with graphical support and offline 3D software
- ▶ CNC-controlled X-R-Z1-Z2 stop (not available with DA 58T)
- ▶ CNC-controlled X-R stop

- ▶ CNC-controlled, motorised table crowning to compensate for bending of top beam and table extension of X axis move area to 1 000 mm
- ▶ Additional rear stop fingers and sheet support arms
- ▶ Table groove of 12.7 x 15.8 mm for LVD type plug-in dies

- ▶ Extension of stand reach
- ▶ Quick release top tool TEDA type for vertical removal of the top tools
- ▶ Parking position for support arms
- ▶ Individual punches and dies
- ▶ Control on left side of machine



GBP-R 3050-175

CNC control DT-15 (standard)

The products are drawn on the graphical 2D control, DT-15 with touchscreen – after completing the drawing, the control computes the bending sequences and the matching axis positions

- ▶ Y1, Y2, X axes and optional R, Z1, Z2 axes and motorised table crowning are supported
- ▶ 15" TFT LCD screen with capacitive touch surface
- ▶ Computation of the following functions: bending sequence, stretched length, immersion depth, changeover point, clamping point, compression force, crowning
- ▶ Bending tools, top beam, table and stop fingers can be freely drawn for optimum collision monitoring
- ▶ Bending sequence simulation
- ▶ USB interface for backing up data
- ▶ Offline PC software

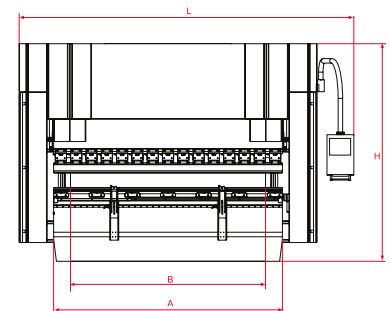
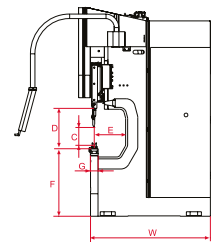

- (A) Bending length
- (B) Distance between columns
- (C) Stroke
- (D) Installation height
- (E) Throat depth

- (F) Table height
- (G) Table width
- (H) Height
- (L) Length
- (W) Depth



Bending brakes



GBP-R 3050-100 - Figure shows optional motorised table crowning and motorised R axis

**More models
on request!**

Technical specifications	Press force	Bending length	Upright passageway	Stroke	Installation height	Throat	Rapid traverse	Bending speed	Retraction	Motor output
GBP-R 1250-60	60 t	1 250 mm	1 050 mm	160 mm	400 mm	350 mm	200 mm/s	10 mm/s	110 mm/s	7.5 kW
GBP-R 2050-60	60 t	2 050 mm	1 700 mm	160 mm	400 mm	350 mm	200 mm/s	10 mm/s	110 mm/s	7.5 kW
GBP-R 2550-100	100 t	2 550 mm	2 200 mm	265 mm	530 mm	410 mm	180 mm/s	10 mm/s	120 mm/s	11 kW
GBP-R 3050-100	100 t	3 050 mm	2 600 mm	265 mm	530 mm	410 mm	180 mm/s	10 mm/s	120 mm/s	11 kW
GBP-R 3050-135	135 t	3 050 mm	2 600 mm	265 mm	530 mm	410 mm	160 mm/s	10 mm/s	120 mm/s	15 kW
GBP-R 3050-175	175 t	3 050 mm	2 600 mm	265 mm	530 mm	410 mm	120 mm/s	10 mm/s	100 mm/s	18.5 kW
GBP-R 3050-220	220 t	3 050 mm	2 600 mm	265 mm	530 mm	410 mm	120 mm/s	10 mm/s	100 mm/s	22 kW
GBP-R 3050-320	320 t	3 050 mm	2 600 mm	365 mm	630 mm	410 mm	100 mm/s	10 mm/s	100 mm/s	37 kW
GBP-R 3750-175	175 t	3 700 mm	3 100 mm	265 mm	530 mm	410 mm	120 mm/s	10 mm/s	100 mm/s	18.5 kW
GBP-R 3750-220	220 t	3 700 mm	3 100 mm	265 mm	530 mm	410 mm	120 mm/s	10 mm/s	100 mm/s	22 kW
GBP-R 4050-175	175 t	4 050 mm	3 600 mm	265 mm	530 mm	410 mm	120 mm/s	10 mm/s	100 mm/s	18.5 kW
GBP-R 4050-220	220 t	4 050 mm	3 600 mm	265 mm	530 mm	410 mm	120 mm/s	10 mm/s	100 mm/s	22 kW
GBP-R 4050-320	320 t	4 050 mm	3 600 mm	365 mm	630 mm	410 mm	100 mm/s	10 mm/s	100 mm/s	37 kW
GBP-R 4050-400	400 t	4 050 mm	3 400 mm	365 mm	630 mm	510 mm	100 mm/s	8 mm/s	80 mm/s	37 kW
GBP-R 6050-220	220 t	6 050 mm	5 100 mm	265 mm	530 mm	410 mm	100 mm/s	10 mm/s	100 mm/s	22 kW
GBP-R 6050-320	320 t	6 050 mm	5 100 mm	365 mm	630 mm	410 mm	100 mm/s	10 mm/s	100 mm/s	37 kW
GBP-R 6050-400	400 t	6 050 mm	5 100 mm	365 mm	630 mm	510 mm	100 mm/s	8 mm/s	80 mm/s	37 kW

Technical specifications	X axis stroke	X axis speed	Table width	Table height	Support arms/rear stop fingers	Oil tank Capacity	Weight	Dimensions L x W x H	Art. no.
GBP-R 1250-60	650 mm	250 mm/s	104 mm	900 mm	2/2 pc.	100 l	3 100 kg	2 300 x 1 200 x 2 350 mm	3821240
GBP-R 2050-60	650 mm	250 mm/s	104 mm	900 mm	2/2 pc.	100 l	3 550 kg	3 200 x 1 200 x 2 350 mm	3822510
GBP-R 2550-100	650 mm	250 mm/s	104 mm	900 mm	2/2 pc.	100 l	8 650 kg	3 800 x 1 670 x 2 750 mm	3823010
GBP-R 3050-100	650 mm	250 mm/s	104 mm	900 mm	2/2 pc.	100 l	9 250 kg	4 200 x 1 670 x 2 750 mm	3823013
GBP-R 3050-135	650 mm	250 mm/s	104 mm	900 mm	2/2 pc.	150 l	10 250 kg	4 200 x 1 680 x 2 750 mm	3823017
GBP-R 3050-175	650 mm	250 mm/s	104 mm	900 mm	2/2 pc.	250 l	11 250 kg	4 250 x 1 700 x 2 750 mm	3823022
GBP-R 3050-220	650 mm	250 mm/s	104 mm	900 mm	2/2 pc.	250 l	12 250 kg	4 250 x 1 770 x 2 900 mm	3823032
GBP-R 3050-320	650 mm	250 mm/s	154 mm	900 mm	2/2 pc.	250 l	17 250 kg	4 300 x 1 820 x 3 230 mm	3823717
GBP-R 3750-175	650 mm	250 mm/s	104 mm	900 mm	2/2 pc.	250 l	17 250 kg	4 950 x 1 700 x 2 900 mm	3823722
GBP-R 3750-220	650 mm	250 mm/s	104 mm	900 mm	2/2 pc.	250 l	14 100 kg	4 950 x 1 770 x 2 900 mm	3824017
GBP-R 4050-175	650 mm	250 mm/s	104 mm	900 mm	2/2 pc.	250 l	12 850 kg	5 250 x 1 700 x 2 750 mm	3824022
GBP-R 4050-220	650 mm	250 mm/s	104 mm	900 mm	2/2 pc.	250 l	14 750 kg	5 250 x 1 770 x 2 900 mm	3824032
GBP-R 4050-320	650 mm	250 mm/s	154 mm	900 mm	2/2 pc.	250 l	20 750 kg	5 300 x 1 910 x 3 230 mm	3824040
GBP-R 4050-400	750 mm	250 mm/s	154 mm	1 040 mm	2/2 pc.	450 l	26 750 kg	5 750 x 2 110 x 3 540 mm	3824060
GBP-R 6050-220	750 mm	250 mm/s	154 mm	1 100 mm	4/4 pc.	250 l	20 590 kg	7 500 x 1 770 x 3 250 mm	3826022
GBP-R 6050-320	750 mm	250 mm/s	154 mm	1 100 mm	4/4 pc.	250 l	28 250 kg	7 500 x 1 910 x 3 450 mm	3826032
GBP-R 6050-400	750 mm	250 mm/s	154 mm	1 220 mm	4/4 pc.	500 l	35 750 kg	7 500 x 2 110 x 3 710 mm	3826040



► Finessler AKAS II safety device

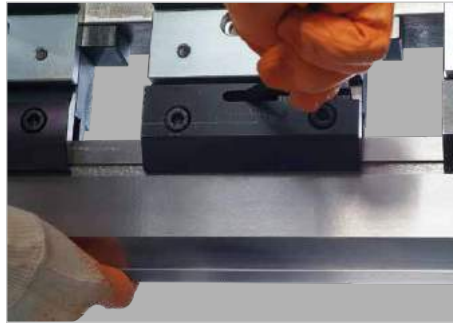

► Manual quick release clamping

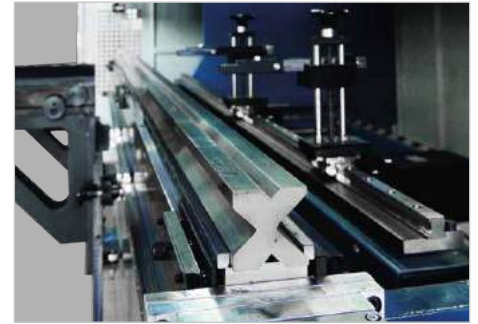

► Die mount



► Sheet support arms displaceable on linear rails

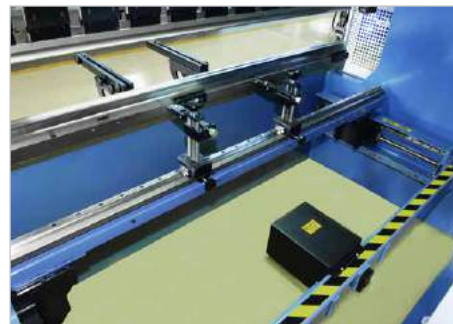

► Rear stop fingers on linear guide adjustable laterally and height adjustable via spindles



► Large installation height
► Large stand reach
► Figure shows motorised table crowning option

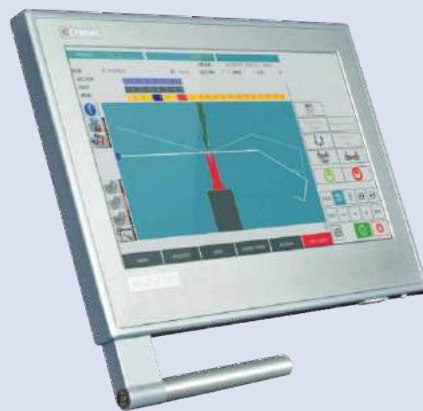

CNC control Cybelec ModEva 19T

This 3D CNC control is operated via a very large 15" touchscreen. Numeric programming of sections and simultaneous display in a 3D graphic. After creating the section, the bending sequence is automatically computed. The bending sequences are graphically simulated. Crowning is supported.

- Up to 12 further optional axes supported in addition to four standard axes (Y1, Y2, X and R) and motorised table crowning
- Automatic computation of the following

functions: bending sequence, rear stop position for known external dimensions, tool safety zones, compression force, bending tolerance, crowning, stretched length, embossing force, radius bending

- Graphical tool and product library
- Collision monitoring
- USB interface for mouse, keyboard and data transfer
- Offline 3D software
- 15" touchscreen



► Motorised R axis

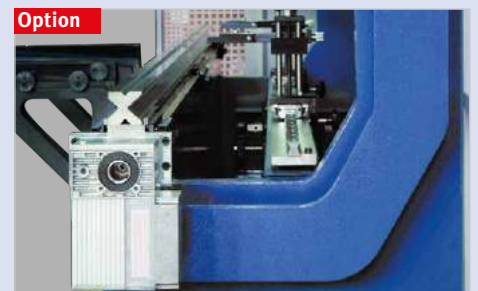

► CNC-controlled, motorised table crowning

Accessories	Art. no.
ModEva 19T 3D with 3D offline software	On request
Delem DA 58T	On request
Prepared for tandem version as of GBP-R 3050-100	3884019

CNC-controlled X-R stop	Art. no.
for GBP-R 1250-40	3884002
for GBP-R 2050-60/2550-100	3884003
for GBP-R 3050-100/3050-135/ 3050-175/3050-220/3050-320	3884004
for GBP-R 3750-175/3750-220	3884005
for GBP-R 4050-175/4050-220/ 4050-320/4050-400	3884006

CNC-controlled X-R-Z1-Z2 stop	Art. no.
for GBP-R 1250-60	On request
for GBP-R 2050-60/2550-100	On request
for GBP-R 3050-100/3050-135/ 3050-175/3050-220/3050-320	On request
for GBP-R 3750-175/3750-220	On request
for GBP-R 4050-175/4050-220/ 4050-320/4050-400	On request

Accessories	Art. no.
CNC-controlled motorised table crowning	
for GBP-R 1250-40/2050-60/2550-100	3884011
for GBP-R 3050-100/3050-135/ 3050-175/3050-220/3050-320	3884012
for GBP-R 3750-175/3750-220	3884013
for GBP-R 4050-175/ 4050-220/4050-320/4050-400	3884014

Additional rear stop fingers	Art. no.
for GBP-R 1250-60/2050-60/ 2550-100/3050-100/3050-135/ 3050-175/3750-175/4050-175	3884015
for GBP-R 3050-220/3050-320/3750-220/4050-220/4050-320/4050-400	3884016

Accessories	Art. no.
Additional support arm	
for GBP-R 1250-40/2050-60/ 2550-100/ 3050-100/3050-135/3050-175/3050-220	3884017
for GBP-R 3050-320/4050-320/4050-400	3884018



► Delem DA 58T

Magnetic drilling
Deburring
Metal grinding
Cutting
Notching & punching
Bending
Presses
Circular saws
Roller conveyors
Metal-cutting band saws

Bending brakes

GBP-S – CNC controlled press brakes with 4 driven axes and motorised crowning

Standard type

- ▶ Very heavy, rugged welded steel construction, stress-free annealing
- ▶ Graphical 3D CNC control Cybelec ModEva 19T with generously dimensioned 19" touchscreen, intuitive operation
- ▶ CNC controlled Y1, Y2, X and R axis and motorised table crowning
- ▶ X axis 650 mm, guided on linear rails and driven via play-free ball screws (as of GBPSR 4050-400 X axis 750 mm)
- ▶ 2 rear stop fingers guided in longitudinal direction on double linear rail (4 pcs. as of bending width of 6 050 mm)
- ▶ Motorised R axis, automatic height adjustment of rear stop fingers via ball screw
- ▶ Positioning of top beam with a resolution of 0.01 mm
- ▶ Measuring system decoupled from side stands to compensate for side stand deflection
- ▶ Manual top tool quick release with cam lever and Promecam/Amada system
- ▶ Complete set of Rehfuß top tools
- ▶ Complete set 4x dies
- ▶ Solid, low-maintenance 4x guides on the top beam
- ▶ Large side stand overhang of 410 mm (510 mm for machines of 400t compression force)
- ▶ 2 sheet support arms with T groove and tilting cams, guided on linear rail in longitudinal direction (4 pcs. as of bending width of 6 050 mm)
- ▶ Fiesler AKAS II safety device travels with the top beam
- ▶ Fiesler FPSC safety PLC
- ▶ Premium hydraulic components (Bosch/Rexroth, Hydac, Atos)
- ▶ Easy operation via mobile foot pedal console with emergency stop
- ▶ Electronically monitored side and rear doors
- ▶ Hydraulic operation



*GBP-S 3050-175 with
Delta-X option*

Custom accesso

- ▶ Graphical 3D CNC control Cybelec ModEva RA Premium
- ▶ Graphical 2D CNC control Delem DA-66T
- ▶ Rear stop Delta X
- ▶ Rear stop X1/X2
- ▶ Rear stop Z1/Z2
- ▶ Rear stop X1/X2-, R1/R2-, Z1/Z2 (tower version)
- ▶ Extension of X axis travel range to 1 000 mm
- ▶ Wila hydraulic workpiece clamping system
- ▶ AKAS 3 m, motorised adjustment of safety laser
- ▶ Motorised, controlled bending aids
- ▶ Pneumatic displacement below tool
- ▶ Additional rear stop fingers and sheet support arms
- ▶ Table groove of 12.7 x 15.8 mm for LVD type plug-in dies
- ▶ Extension of stand reach
- ▶ Extension of piston stroke
- ▶ Quick release top tool Speedtouch type for vertical removal of the top tools
- ▶ Parking position for support arms
- ▶ Individual punches and dies
- ▶ Control on left side of machine
- ▶ Prepared for tandem operation (as of bending width 3 050 mm)



Rear view with optional 6-axis rear stop

Press brake GBP-S

More models
on request!



GBP-S 3050-175
with Delta-X option

Technical specifications	Press force	Bending length	Stand passageway	Stroke	Installation height	Throat	Rapid traverse	Bending speed	Retraction	Motor output	X axis stroke	X axis speed
GBP-S 1250-60	60 t	1 250 mm	1 050 mm	265 mm	530 mm	410 mm	200 mm/s	10 mm/s	110 mm/s	7.5	650 mm	500 mm/s
GBP-S 2050-60	60 t	2 050 mm	1 700 mm	265 mm	530 mm	410 mm	200 mm/s	10 mm/s	110 mm/s	7.5	650 mm	500 mm/s
GBP-S 2550-100	100 t	2 550 mm	2 200 mm	265 mm	530 mm	410 mm	180 mm/s	10 mm/s	120 mm/s	11	650 mm	500 mm/s
GBP-S 3050-100	100 t	3 050 mm	2 600 mm	265 mm	530 mm	410 mm	180 mm/s	10 mm/s	120 mm/s	11	650 mm	500 mm/s
GBP-S 3050-135	135 t	3 050 mm	2 600 mm	265 mm	530 mm	410 mm	160 mm/s	10 mm/s	120 mm/s	15	650 mm	500 mm/s
GBP-S 3050-175	175 t	3 050 mm	2 600 mm	265 mm	530 mm	410 mm	120 mm/s	10 mm/s	100 mm/s	18.5	650 mm	500 mm/s
GBP-S 3050-220	220 t	3 050 mm	2 600 mm	265 mm	530 mm	410 mm	120 mm/s	10 mm/s	100 mm/s	22	650 mm	500 mm/s
GBP-S 3050-320	320 t	3 050 mm	2 600 mm	265 mm	630 mm	410 mm	100 mm/s	10 mm/s	100 mm/s	37	650 mm	500 mm/s
GBP-S 3750-175	175 t	3 700 mm	3 100 mm	265 mm	530 mm	410 mm	120 mm/s	10 mm/s	100 mm/s	18.5	650 mm	500 mm/s
GBP-S 3750-220	220 t	3 700 mm	3 100 mm	265 mm	530 mm	410 mm	120 mm/s	10 mm/s	100 mm/s	22	650 mm	500 mm/s
GBP-S 4050-175	175 t	4 050 mm	3 600 mm	265 mm	530 mm	410 mm	120 mm/s	10 mm/s	100 mm/s	18.5	650 mm	500 mm/s
GBP-S 4050-220	220 t	4 050 mm	3 600 mm	265 mm	530 mm	410 mm	120 mm/s	10 mm/s	100 mm/s	22	650 mm	500 mm/s
GBP-S 4050-320	320 t	4 050 mm	3 600 mm	365 mm	630 mm	410 mm	100 mm/s	10 mm/s	100 mm/s	37	650 mm	500 mm/s
GBP-S 4050-400	400 t	4 050 mm	3 400 mm	365 mm	630 mm	510 mm	100 mm/s	8 mm/s	80 mm/s	37	750 mm	350 mm/s
GBP-S 4050-600	600 t	4 050 mm	3 100 mm	365 mm	700 mm	510 mm	80 mm/s	7 mm/s	80 mm/s	45	750 mm	350 mm/s
GBP-S 6050-220	220 t	6 050 mm	5 100 mm	265 mm	530 mm	410 mm	80 mm/s	10 mm/s	100 mm/s	22	750 mm	350 mm/s
GBP-S 6050-320	320 t	6 050 mm	5 100 mm	365 mm	630 mm	410 mm	100 mm/s	10 mm/s	100 mm/s	37	750 mm	350 mm/s
GBP-S 6050-400	400 t	6 050 mm	5 100 mm	365 mm	630 mm	510 mm	100 mm/s	8 mm/s	80 mm/s	37	750 mm	350 mm/s

Technical specifications	R axis stroke	R axis speed	Table width	Table height	Crowning	Underfloor	Support arms	Oil tank capacity	Weight approx.	Dimensions L x W x H	Art. no.
GBP-S 1250-60	250 mm	350 mm/s	104 mm	900 mm	motorised	-	2/2 pc.	100 l	4 900 kg	2 550 x 1 650 x 2 750 mm	3821241
GBP-S 2050-60	250 mm	350 mm/s	104 mm	900 mm	motorised	-	2/2 pc.	100 l	5 600 kg	3 400 x 1 650 x 2 750 mm	3822061
GBP-S 2550-100	250 mm	350 mm/s	104 mm	900 mm	motorised	-	2/2 pc.	100 l	8 900 kg	3 800 x 1 670 x 2 750 mm	3822511
GBP-S 3050-100	250 mm	350 mm/s	104 mm	900 mm	motorised	-	2/2 pc.	100 l	9 500 kg	4 200 x 1 670 x 2 750 mm	3823011
GBP-S 3050-135	250 mm	350 mm/s	104 mm	900 mm	motorised	-	2/2 pc.	150 l	10 500 kg	4 200 x 1 680 x 2 750 mm	3823014
GBP-S 3050-175	250 mm	350 mm/s	104 mm	900 mm	motorised	-	2/2 pc.	250 l	11 500 kg	4 250 x 1 700 x 2 750 mm	3823018
GBP-S 3050-220	250 mm	350 mm/s	104 mm	900 mm	motorised	-	2/2 pc.	250 l	12 500 kg	4 250 x 1 770 x 2 900 mm	3823023
GBP-S 3050-320	250 mm	350 mm/s	154 mm	900 mm	motorised	-	2/2 pc.	250 l	17 500 kg	4 300 x 1 820 x 3 230 mm	3823033
GBP-S 3750-175	250 mm	350 mm/s	104 mm	900 mm	motorised	-	2/2 pc.	250 l	13 000 kg	4 950 x 1 700 x 2 900 mm	3823718
GBP-S 3750-220	250 mm	350 mm/s	104 mm	900 mm	motorised	-	2/2 pc.	250 l	14 360 kg	4 950 x 1 770 x 2 900 mm	3823723
GBP-S 4050-175	250 mm	350 mm/s	104 mm	900 mm	motorised	-	2/2 pc.	250 l	13 100 kg	5 250 x 1 700 x 2 750 mm	3824018
GBP-S 4050-220	250 mm	350 mm/s	104 mm	900 mm	motorised	-	2/2 pc.	250 l	15 000 kg	5 250 x 1 770 x 2 900 mm	3824023
GBP-S 4050-320	250 mm	350 mm/s	154 mm	900 mm	motorised	-	2/2 pc.	250 l	21 000 kg	5 300 x 1 910 x 3 230 mm	3824033
GBP-S 4050-400	250 mm	300 mm/s	300 mm	1 040 mm	motorised	-	2/2 pc.	450 l	27 000 kg	5 750 x 2 110 x 3 540 mm	3824041
GBP-S 4050-600	250 mm	300 mm/s	300 mm	990 mm	motorised	1 200 mm	2/2 pc.	500 l	40 500 kg	5 650 x 3 250 x 3 825 mm	3824061
GBP-S 6050-220	250 mm	300 mm/s	154 mm	1 100 mm	motorised	-	4/4 pc.	250 l	20 840 kg	7 500 x 1 770 x 3 250 mm	3826023
GBP-S 6050-320	250 mm	300 mm/s	154 mm	1 100 mm	motorised	-	4/4 pc.	250 l	28 500 kg	7 500 x 1 910 x 3 450 mm	3826033
GBP-S 6050-400	250 mm	300 mm/s	300 mm	1 220 mm	motorised	-	4/4 pc.	500 l	36 000 kg	7 500 x 2 110 x 3 710 mm	3826041

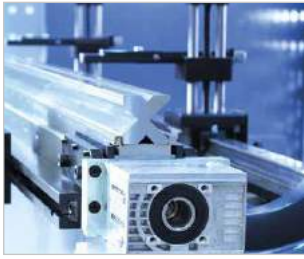

▶ Motorised table crowning



▶ R axis (Standard)
▶ X axis (Standard)

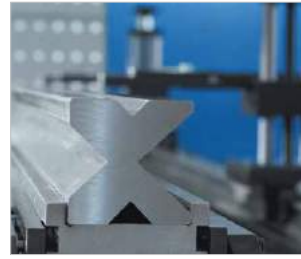

▶ Standard centring rail with optional, tempered and polished Multi-V die

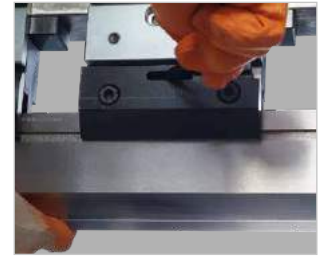

▶ Manual quick release clamping



▶ Fiessler AKAS II safety device

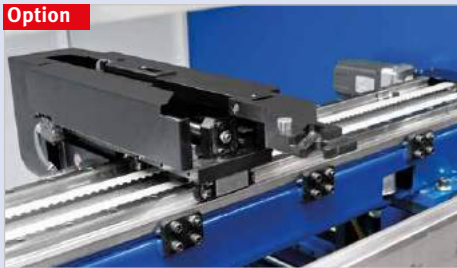

▶ Delta-X axis option



▶ Options rear stop with Z1 and Z2 axis and Delta-X

Accessories	Art. no.	Accessories	Art. no.	Accessories	Art. no.
3D CNC control	3883997	hydr. quick release clamping top WILA max. 180t/m PowerPack	3885025	mech. quick release clamping bottom WILA max. 200t/m GBP-S 2550-100	3885041
Cybelec ModEva RA Premium		hydr. quick release clamping top WILA max. 180t/m PowerPack GBP-S 4050-175/ 4050-220/4050-320/4050-400/4050-600	3885026	mech. quick release clamping bottom WILA max. 200t/m GBP-S 3050-100/3050-135/3050-175/3050-220/3050-320	3885042
2D CNC control Delem DA-66T	3883998	mech. quick release clamping top WILA max. 180t/m GBP-S 1250-40	3885027	mech. quick release clamping bottom WILA max. 200t/m GBP-S 3750-175/3750-220	3885043
3D CNC control Delem DA-69T	3883999	mech. quick release clamping top WILA max. 180t/m GBP-S 2050-60	3885028	mech. quick release clamping bottom WILA max. 200t/m GBP-S 4 050-175/4050-220/4050-320/4050-400/4050-600	3885044
Z1, Z2 axes GBP-S 1250-40/2050-60	3885001	mech. quick release clamping top WILA max. 180t/m GBP-S 2550-100	3885029	WILA PowerPack for hydr. quick release clamping	3885045
Z1, Z2 axes GBP-S 25100	3885002	mech. quick release clamping top WILA max. 180t/m GBP-S 3050-100/3050-135/3050-175/3050-220/3050-320	3885030	Stroke 365 mm GBP 3050-100/3050-135/3050-175	3885046
Z1, Z2 axes GBP-S 30100/30135/30175/30220/30320	3885003	mech. quick release clamping top WILA max. 180t/m GBP-S 3750-175/3750-220	3885031	Additional support arms GBP-S 1250-40/2050-40/2050-60/2550-100/3050-100/3050-135/3050-175/3050-220	3884017
Z1, Z2 axes GBP-S 37175/37220	3885004	mech. quick release clamping top WILA max. 180t/m GBP-S 4050-175/4050-220/4050-320/4050-400/4050-600	3885032	Additional support arms GBP-S 3050-320/4050-320/4050-400/4050-600	3884018
Z1, Z2 axes GBP-S 40175/40220/40320/40400/40600	3885005	hydr. quick release clamping bottom WILA max. 200t/m PowerPack GBP-S 1250-40	3885033	Manual centralised lubrication system	3885047
X1, X2 axes GBP-S 1240/2060	3885006	hydr. quick release clamping bottom WILA max. 200t/m PowerPack GBP-S 2050-60	3885034	Additional rear stop fingers GBP-S 1250-40/2050-40/2050-60/2550-100/3050-100/3050-135/3050-175/3750-175/4050-175	3885048
X1, X2 axes GBP-S 25100	3885007	hydr. quick release clamping bottom WILA max. 200t/m PowerPack GBP-S 2550-100	3885035	Additional rear stop fingers GBP-S GBP-S 3050-220/3050-320/3750-220/4050-220/4050-320/4050-400/4050-600	3885049
X1, X2 axes GBP-S 30100/30135/30175/30220/30320	3885008	hydr. quick release clamping bottom WILA max. 200t/m PowerPack GBP-S 3050-100/3050-135/3050-175/3050-220/3050-320	3885036	Depositing zone for support arms (1 metre) GBP-S 3050-100/3050-135/3050-175/3050-220/3750-175/3750-220/4050-175/4050-220/4050-320	3885050
X1, X2 axes GBP-S 37175/37220	3885009	hydr. quick release clamping bottom WILA max. 200t/m PowerPack GBP-S 4050-175/4050-220/4050-320/4050-400/4050-600	3885037	Depositing zone for support arms (1 metre) GBP-S 4050-400/4050-600	3885051
X1, X2 axes GBP-S 40175/40220/40320/40400/40600	3885010	hydr. quick release clamping bottom WILA max. 200t/m PowerPack GBP-S 4050-175/4050-220/4050-320/4050-400/4050-600	3885038	Additional support arms GBP-S 1250-40/2050-60/2550-100/3050-100/3050-135/3050-175/3050-220/3050-320/3750-175/3750-220/4050-175/4050-220/4050-320	3885053
R1, R2 axes GBP-S 1240/2060	3885011	hydr. quick release clamping bottom WILA max. 200t/m PowerPack GBP-S 1250-40	3885039	Additional support arms GBP-S 1250-40/2050-60/2550-100/3050-100/3050-135/3050-175/3050-220/3050-320/3750-175/3750-220/4050-175/4050-220/4050-320	3885054
R1, R2 axes GBP-S 25100/30100/30135	3885012	hydr. quick release clamping bottom WILA max. 200t/m PowerPack GBP-S 2050-60	3885040	4050-220/4050-320 Additional support arms GBP-S 4050-400/4050-600	3884019
R1, R2 axes GBP-S 30175/30220/30320	3885013	hydr. quick release clamping bottom WILA max. 200t/m PowerPack GBP-S 2550-100		Preparation for tandem version as of GBP-S 3050-100	169
R1, R2 axes GBP-S 37175/37220	3885014	hydr. quick release clamping bottom WILA max. 200t/m PowerPack GBP-S 3050-100/3050-135/3050-175/3050-220/3050-320			
R1, R2 axes GBP-S 40175/40220/40320	3885015				
R1, R2 axes GBP-S 40400	3885016				
R1, R2 axes GBP-S 40600	3885017				
X axis = 1 000 mm, with light barrier on rear side	3885018				
Pneumatic height adjustment front support arms	3885019				
man. quick release clamping GBP-S 3750-175/3750-220/4050-175/4050-220	3884010				
hydr. quick release clamping top WILA max. 180t/m PowerPack GBP-S 1250-40	3885021				
hydr. quick release clamping top WILA max. 180t/m PowerPack GBP-S 2 050-60	3885022				
hydr. quick release clamping top WILA max. 180t/m PowerPack GBP-S 2550-100	3885023				
hydr. quick release clamping top WILA max. 180t/m PowerPack	3885024				
GBP-S 3050-100/ 3050-135/3050-175/3050-220/3050-320					

Bending brakes

Accessories for bending brakes GBP

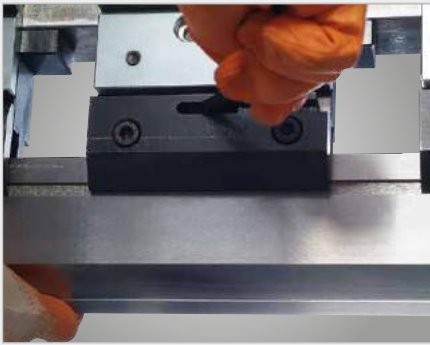

► Manual quick release clamping for fast tool changes (standard for R, S and Servo)



► Hydraulic top tool clamping "WILA" for easy tool changes within seconds (optional)

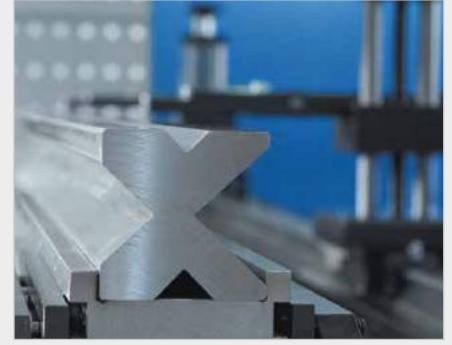

► Standard centring rail with optional, tempered and polished Multi-V die



► Movable front support brackets (standard for R, S and Servo)



► CNC-controlled, motorised table crowning (standard for S and Servo series)



► Rear stop system with R axis (standard for S and Servo series)

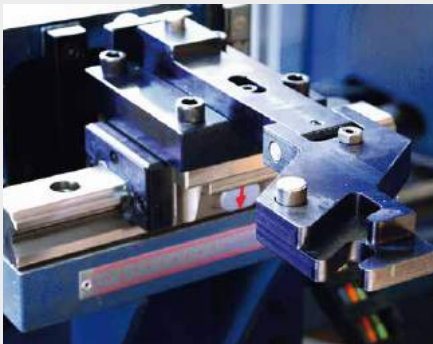

► Custom design rear stop fingers



► Delta X (option)



► Hydraulic tool clamping (option)

Commissioning & professional initial training

When purchasing a Metallkraft machine, we recommend that customers call in one of our specialists to complete commissioning and provide induction training on site.

Commissioning and initial training for standard machines	Art. no.
Initial training & training for CNC controls	EINWMET EINWCNCMET
Duration of commissioning and initial training for custom machines*	EINWGBPMET

* DBM, MBBS, FSM, HTBS, MSBM Pro, controlled PRM and MRB, GBP, LMS 400A and metal band saws with X-control

Commissioning includes:

- Installing the machine
- (Unloading and transporting the machine to the installation location; providing the electrical and pneumatic connections, and the floor anchors or assembly plates are the purchaser's responsibility.)
- Cleaning, tooling and aligning
- Checking all functions

Initial training on the machine includes:

- an exhaustive explanation of the controls
- an explanation of the individual functions
- Setting and explaining the basic parameters
- Explaining the safety instructions as per best practices

For programmable models, additionally:

- an exhaustive explanation of the controls
- an explanation of the individual functions
- Setting and explaining the basic parameters
- Explaining the safety instructions as per best practices

Duration of commissioning and initial training:

8 hours per day, including travel times to and from the site, plus travel expenses at €0.69 per km, plus any charges for overnight stays as applicable.

If the initial training time is 8 hours, the travel time is invoiced at €48 /hour.

This also applies for any different or additional services, which must be ordered separately on site and will be invoiced on individual basis.

If the customer requires and requests installation and connecting of the machine, the customer is obliged to support our technician to the best of customer's ability and to provide the required helpers, tools and equipment at customer's own expense.

Punches and dies

Matching punches and dies for various applications

A number of examples from our comprehensive range of tools for press brakes are listed here. In addition to our comprehensive offer of standard tools, custom

tools can be tailored to your individual requirements – we are always happy to advise you on the topic of punches and dies.

Examples of top tools:

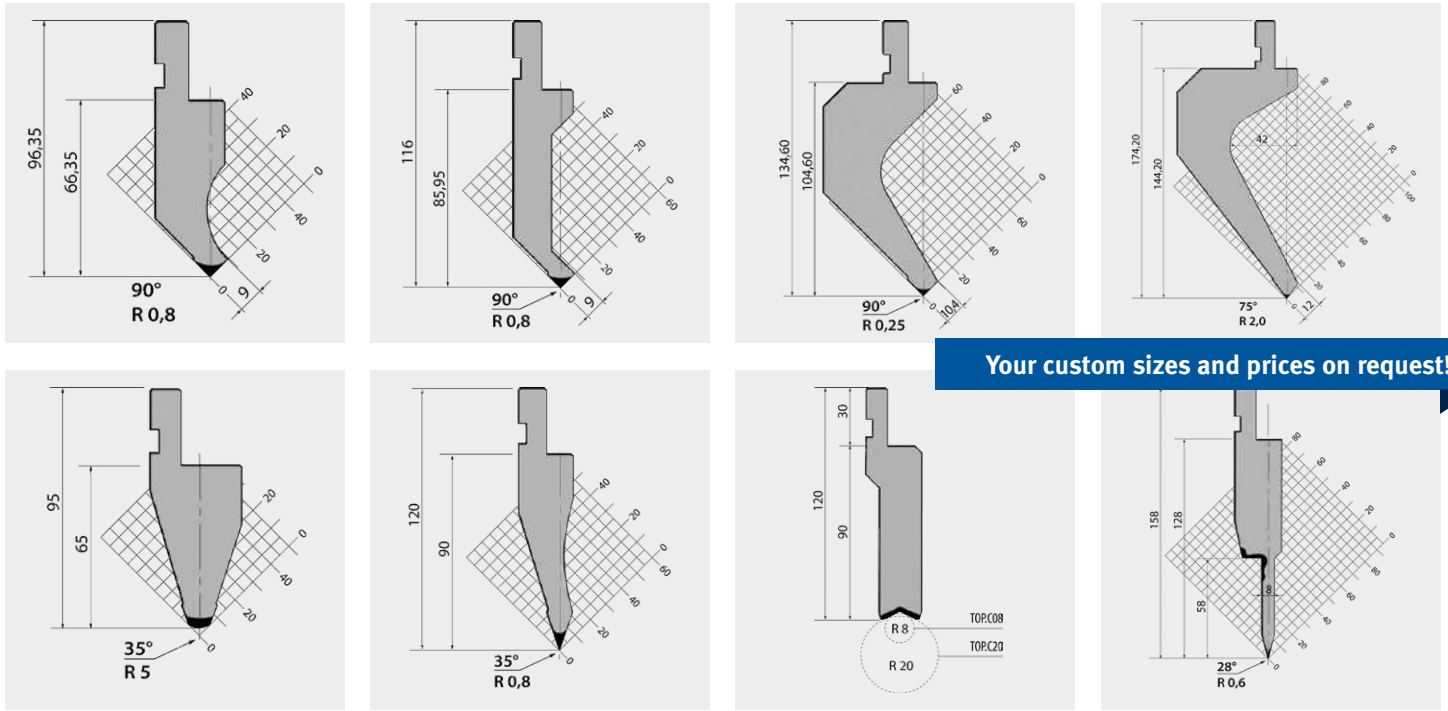

Examples of bottom tools:

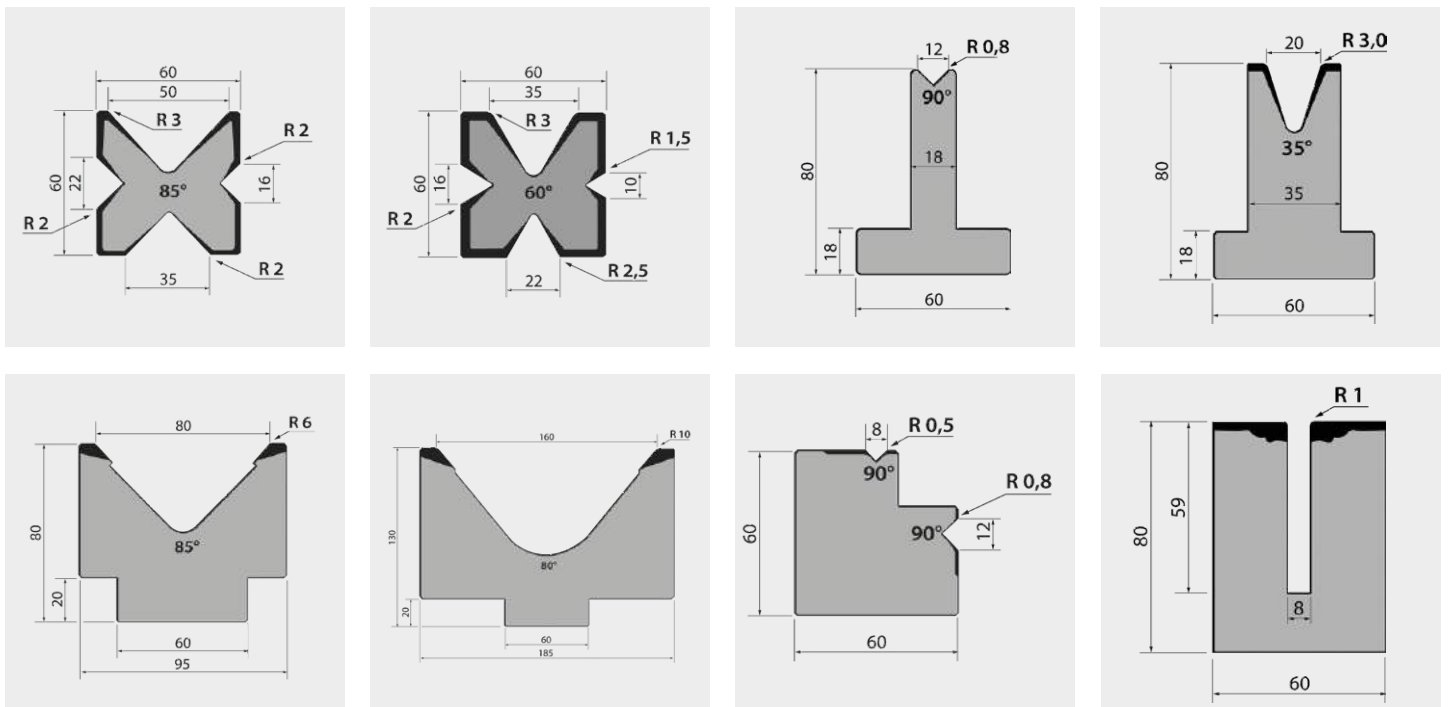



Presses

Hydraulic workshop presses

WPP 15 T – Hydraulic table workshop press with hand pump and moving cylinder



- ▶ For all repair and assembly work, e.g.: straightening axles, subframes, shafts, etc.; pressing bearings, bolts and bushings in and out; pressing and crimping work; load tests and weld sample testing, etc.
- ▶ Sturdy welded design
- ▶ Rugged frame with holes for adjusting the work table
- ▶ Reliable, high-precision hydraulics, made in Europe
- ▶ Manual pressure build up by actuating the pump lever
- ▶ With automatic piston return
- ▶ With chrome-plated cylinder pistons
- ▶ Pressing pressure can be read off on gauge with safety valve for overload protection
- ▶ includes a 2-part prism set for insert-placing round materials
- ▶ For processing flat materials, pressing in bearings, bolts and similar, please use the optional perforated plate



WPP 15 T

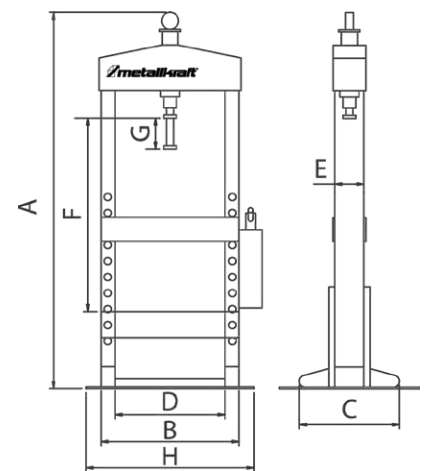

Scope of delivery:
 > 2-part prism set for insert-placing round materials

Model	WPP 15 T
Art. no.	4001115

Technical specifications	
Services	15 t
Piston travel	340 mm
max. load on prism jaw	3.5 t
Weight	105 kg

Dimensions	
A - Height	1 350 mm
B - Width without pump	690 mm
C - Depth	500 mm
D - Clear width	550 mm
E - Depth of hole frame	150 mm
F - Clear height	550 mm
G - Piston stroke	160 mm
H - Width with pump	900 mm

! For processing flat materials, pressing in bearings, bolts and similar, please use the optional perforated plate for WPP 15 T, Art. no. 4104005.



6-part punching mandrel set with perforated plate, Ø 29, 24, 18, 14, 10, 5 mm

Accessories	Art. no.
6-part punching mandrel set with perforated plate for WPP 15 T	4101115
Perforated plate for WPP 15 T	4104005

WPP – Hydraulic workshop presses with moving cylinder and hand pump

- ▶ For all repair and assembly work, e.g.: straightening axles, subframes, shafts, etc.; pressing bearings, bolts and bushings in and out; pressing and crimping work; load tests and weld sample testing, etc.
- ▶ Sturdy welded design
- ▶ Rugged frame with holes for adjusting the work table
- ▶ Reliable, high-precision hydraulics, made in Europe
- ▶ With chrome-plated cylinder pistons
- ▶ Pressing pressure can be read off on gauge
- ▶ Piston return, automatic
- ▶ safety valve for overload protection
- ▶ For processing flat materials, pressing in bearings, bolts and similar, please use the optional perforated plate

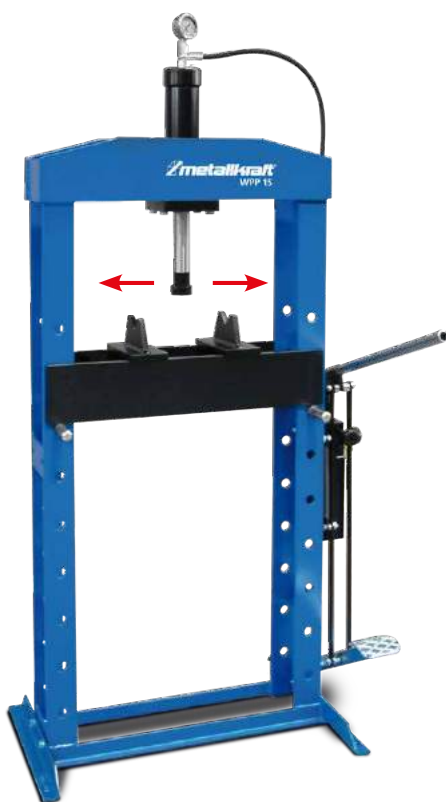

WPP 15
Figures shows optionally available foot pedal for pump



WPP 30

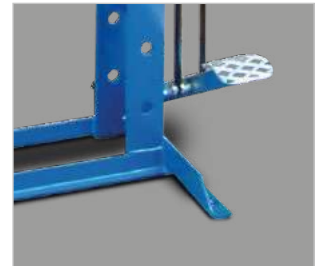

Accessories retrofitting kit
foot pedal for pump

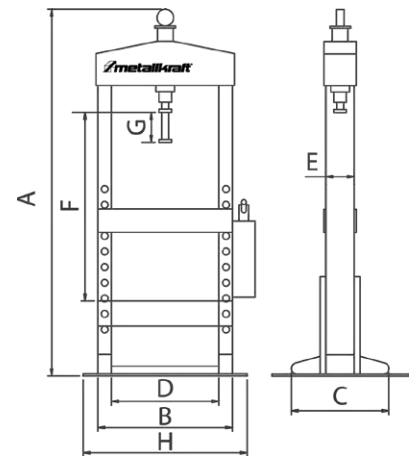

Scope of delivery:

- > 2-part prism set for insert-placing round materials
- > Winch for lifting and lowering the table (for WPP 30)

Model	WPP 15	WPP 20	WPP 30
Art. no.	4001015	4001020	4001030
Technical specifications			
Services	15 t	20 t	30 t
Piston travel	340 mm	380 mm	450 mm
max. load on prism jaw	3.5 t	5 t	7.5 t
Weight	120 kg	140 kg	230 kg

Dimensions in mm	WPP 15	WPP 20	WPP 30
A - Height	1 890 mm	1 900 mm	1 980 mm
B - Width without pump	620 mm	770 mm	890 mm
C - Depth	600 mm	600 mm	600 mm
D - Clear width	500 mm	610 mm	710 mm
E - Depth of hole frame	150 mm	150 mm	150 mm
F - Clear height	1 000 mm	1 000 mm	1 000 mm
G - Piston stroke	160 mm	160 mm	160 mm
H - Width with pump	900 mm	950 mm	1 150 mm

 For processing flat materials, pressing in bearings, bolts and similar, please use the optional perforated plate



6-part punching mandrel set with perforated plate, Ø 29, 24, 18, 14, 10, 5 mm

Accessories	Art. no.
6-part punching mandrel set with perforated plate for WPP 15	4101115
for WPP 20	4101020
for WPP 30	4101030
Perforated plate for WPP 15 and WPP 20	4104005
Perforated plate for WPP 30	4104003
Retrofit set foot pedal for pump without assembly for WPP 15 and WPP 20	4101021

Hydraulic workshop presses

WPP BK – Hydraulic workshop presses with hand and foot pump moving cylinder



- ▶ For all repair and assembly work, e.g.: straightening axles, subframes, shafts, etc.; pressing bearings, bolts and bushings in and out; pressing and crimping work; load tests and weld sample testing, etc.
- ▶ Sturdy welded design
- ▶ Rugged frame with holes for adjusting the work table
- ▶ Reliable, high-precision hydraulics, made in Europe
- ▶ Pressure build up by actuating the hand or foot pump lever
- ▶ Both hands free for fixing the workpiece thanks to foot pump
- ▶ Pressing pressure can be read off on gauge
- ▶ With automatic piston return
- ▶ With safety valve for overload protection



WPP 20 BK

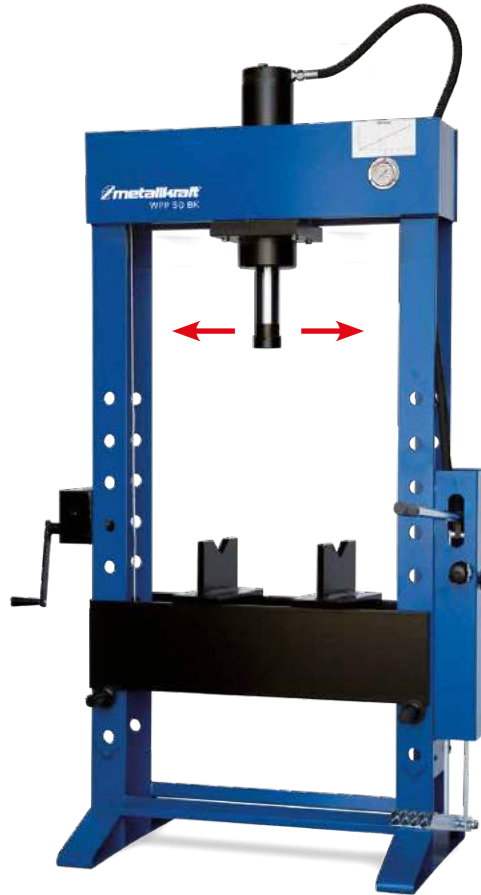

WPP 50 BK

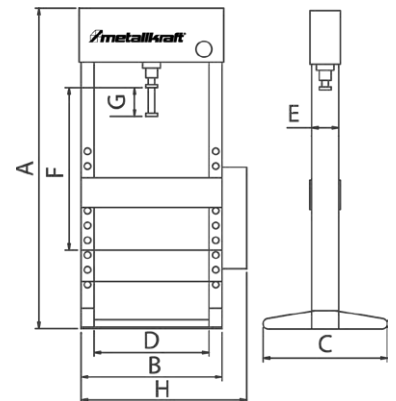

Scope of delivery:

- > 2-part prism set for insert-placing round materials
- > Hand and foot lever
- > Winch for lifting and lowering the table (for WPP 30 BK, WPP 50 BK)

Model	WPP 20 BK	WPP 30 BK	WPP 50 BK
Art. no.	4002020	4002030	4002050
Technical specifications			
Services	20 t	30 t	50 t
Piston travel	450 mm	550 mm	500 mm
max. load on prism jaw	5 t	7.5 t	12.5 t
Weight	210 kg	280 kg	360 kg

Dimensions	WPP 20 BK	WPP 30 BK	WPP 50 BK
A - Height	1 750 mm	1 920 mm	2 000 mm
B - Width without pump	870 mm	990 mm	990 mm
C - Depth	650 mm	650 mm	650 mm
D - Clear width	690 mm	790 mm	790 mm
E - Depth of hole frame	180 mm	200 mm	210 mm
F - Clear height	950 mm	1 030 mm	1 000 mm
G - Piston stroke	160 mm	160 mm	150 mm
H - Width with pump	1010 mm	1240 mm	1 400 mm

! For processing flat materials, pressing in bearings, bolts and similar, please use the optional perforated plate



6-part punching mandrel set with perforated plate, Ø 29, 24, 18, 14, 10, 5 mm

Accessories	Art. no.
6-part punching mandrel set with perforated plate for WPP 20 BK	4102020
6-part punching mandrel set with perforated plate for WPP 30 BK	4102030
6-part punching mandrel set with perforated plate for WPP 50 BK	4102050
Perforated plate for WPP 20 BK	4104002
Perforated plate for WPP 30 BK	4104003
Perforated plate for WPP 50 BK	4104004

WPP 50 M – Hydraulic workshop press with electric pump and double-action cylinder

- ▶ For all repair and assembly work, e.g.: straightening axles, subframes, shafts, etc.; pressing bearings, bolts and bushings in and out; pressing and crimping work; load tests and weld sample testing, etc.
- ▶ Sturdy welded design
- ▶ Rugged frame with holes for height adjustment of the press table
- ▶ With automatic switch-over from accelerated idle speed to slower working speed of the cylinder
- ▶ Reliable, high-precision hydraulics, made in Europe
- ▶ With safety valve for overload protection

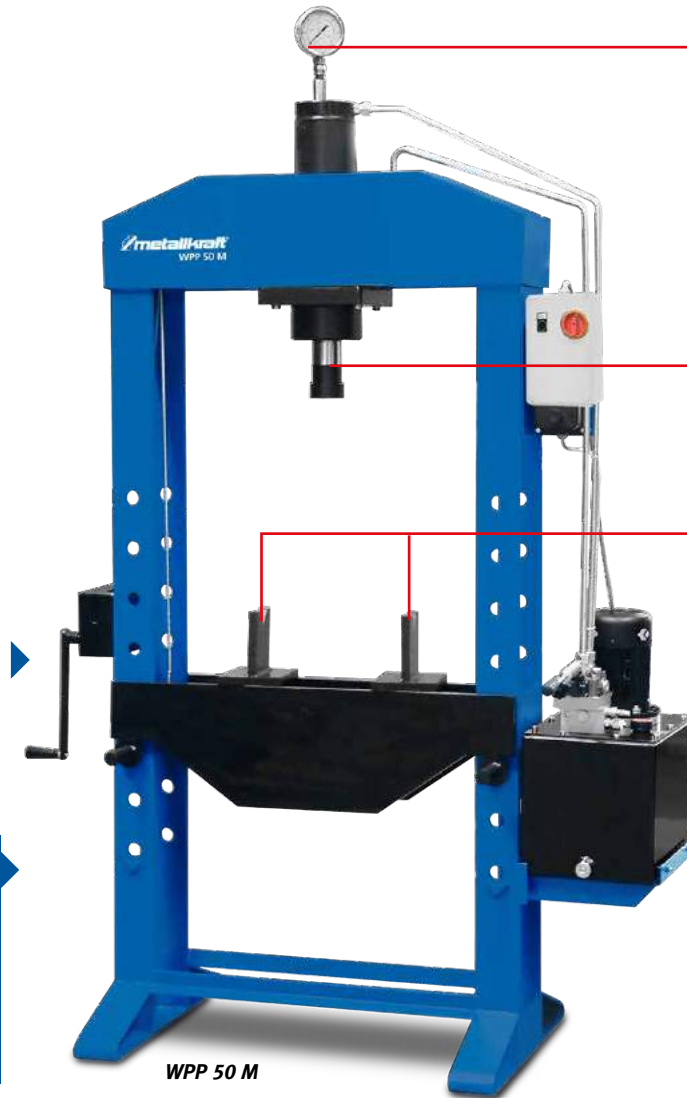

▶ Pressing pressure can be read off on gauge

▶ Equipped with double-action cylinder

- ▶ includes a 2-part prism set for insert-placing round materials
- ▶ For processing flat materials, pressing in bearings, bolts and similar, please use the optional perforated plate

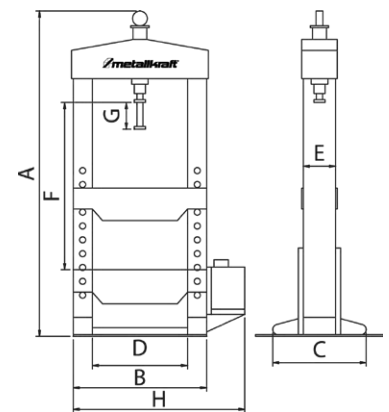

Scope of delivery:

- > 2-part prism set for insert-placing round materials
- > Hand lever
- > Winch for lifting and lowering the table
- > Steel chain for table height adjustment

Model	WPP 50 M
Art. no.	4003050

Technical specifications	
Services	50 t
max. load on prism jaw	12.5 t
Slow feed	1.5 mm/sec.
Fast feed	10 mm/sec.
Motor output	1.5 kW
Mains connection 50 Hz	400 V
Weight	420 kg

Dimensions	WPP 50 M
A - Height	2 290 mm
B - Width without pump	985 mm
C - Depth	650 mm
D - Clear width	790 mm
E - Depth of hole frame	210 mm
F - Clear height	1 050 mm
G - Piston stroke	250 mm
H - Width with pump	1 350 mm



optional 6-part punching mandrel set Ø 29, 24, 18, 14, 10, 5 mm

Accessories	Art. no.
6-part punching mandrel set with perforated plate for WPP 50 M	4103050
Perforated plate for WPP 50 M	4104004

Hydraulic workshop presses

WPP HBK – Heavy, hydraulic workshop presses with moving piston and two piston feed speeds



- ▶ Equally suited to assembly and straightening work, workpiece testing, or pressing bearings and other components in or out
- ▶ Ideal for technical workshops, repair shops and technical training institutions
- ▶ With two piston feed speeds and pressure control via throttle screw
- ▶ Pressure gauge for pressure display
- ▶ Heavy, welded machine frame made of steel sections to absorb the incident press force of the cylinder
- ▶ The hydraulics work with great precision in both electric and manual mode
- ▶ Adjustment of the cylinder via rack on hand wheel
- ▶ Heavy-duty and durable welded designed



WPP 60 HBK



WPP 100 HBK

- ▶ Enhanced stability thanks to improved machine foot design
- ▶ Cylinder adjustment via handle and hand wheel
- ▶ Pressure gauge on machine side

Model	WPP 60 HBK	WPP 100 HBK	WPP 100 HBK D 1500	WPP 160 HBK	WPP 160 HBK D 1500	WPP 200 HBK
Art. no.	4013060	4013100	4013101	4013160	4013161	4013200

Technical specifications	WPP 60 HBK	WPP 100 HBK	WPP 100 HBK D 1500	WPP 160 HBK	WPP 160 HBK D 1500	WPP 200 HBK
Services	60 t	100 t	100 t	160 t	160 t	200 t
Press speed	1.5 mm/s	1.5 mm/s	1.5 mm/s	1.5 mm/s	1.5 mm/s	1.2 mm/s
Feed speed	10 mm/s	10 mm/s	10 mm/s	10 mm/s	10 mm/s	10 mm/s
Motor output	1.5 kW	1.5 kW	1.5 kW	1.5 kW	1.5 kW	4 kW
Power connection	400 V	400 V	400 V	400 V	400 V	400 V
Weight	480 kg	980 kg	1 280 kg	1 480 kg	1 820 kg	2 700 kg
Dimensions						
A – Height	2 290 mm	2 280 mm	2 280 mm	2 450 mm	2 450 mm	2 600 mm
B - Width without pump	990 mm	1 290 mm	1 790 mm	1 320 mm	1 820 mm	1 900 mm
C - Width with pump	1 350 mm	1 600 mm	2 100 mm	1 950 mm	2 450 mm	2 450 mm
D – Depth	650 mm	850 mm	850 mm	1 000 mm	1 000 mm	1 100 mm
E - Clear width	790 mm	1 030 mm	1 530 mm	1 020 mm	1 520 mm	1 500 mm
F - Clear height	1 000 mm	1 000 mm	1 000 mm	1 020 mm	1 020 mm	1 000 mm
G - Depth of hole frame	180 mm	265 mm	265 mm	300 mm	300 mm	400 mm
H - Piston stroke	300 mm	320 mm	320 mm	400 mm	400 mm	400 mm
I – Piston travel	450 mm	550 mm	1 000 mm	550 mm	950 mm	800 mm



Quality
made in
Europe



WPP 160 HBK



► Convenient and clear-cut operation of the hydraulic power unit

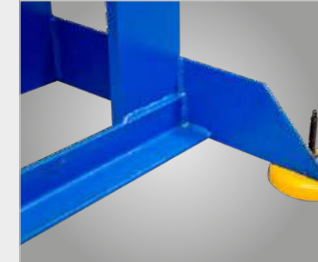

► Sturdy frame and flatter design at the same time



► Fast and easy adjustment of the cylinder via gear rack and hand wheel

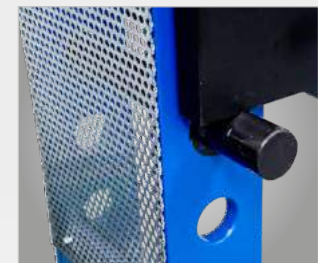

► Easy table height adjustment thanks to hydraulic cylinder and fastening bolts

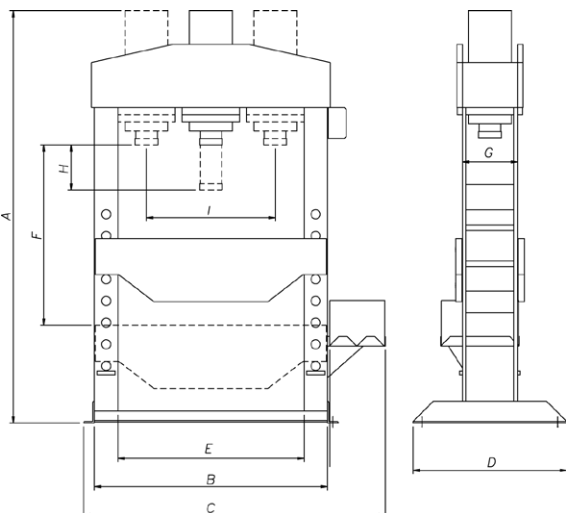

Accessories	Art. no.
Prism block set* (WPP 60 HBK)	4105060
Prism block set* (WPP 100 HBK)	4105100
Prism block set* (WPP 160 HBK)	4105160
Prism block set* (WPP 200 HBK)	4100200
* Set includes 2 prism blocks	
WPP 60 HBK loadable with 30 tonnes per block	
WPP 100 HBK loadable with 50 tonnes per block	
WPP 160 HBK loadable with 80 tonnes per block	
WPP 200 HBK loadable with 100 tonnes per block	
Accessories	Art. no.
Perforated plate 60t (WPP 60)	4106060
Pressure barb set (WPP 60)	4107060
Perforated plate 100t (WPP 100)	4106100
Pressure barb set (WPP 100)	4107100
Perforated plate 160t (WPP 160)	4106160
Pressure barb set (WPP 160)	4107160

Magnetic drilling
Deburring
Metal grinding
Cutting
Notching & punching
Bending
Presses
Circular saws
Roller conveyors
Metal-cutting band saws

WPP VH – All hydraulic workshop press. Rugged design with moving cylinder

- ▶ For pressing bearings, bolts and bushings in and out, and for repair and assembly work, pressing work, load tests and weld sample testing, and much more.
- ▶ With pressure mandrel adapter for 2 different press diameters of the cylinder
- ▶ Hydraulic control of the stroke and right/left motion of the cylinder, and height adjustment of the table independently of the main cylinder
- ▶ Cylinder laterally displaceable via lever
- ▶ Pressure-sensitive manual lever for controlling the feed speeds
- ▶ Pressing pressure can be read off on gauge
- ▶ Milled steel structure

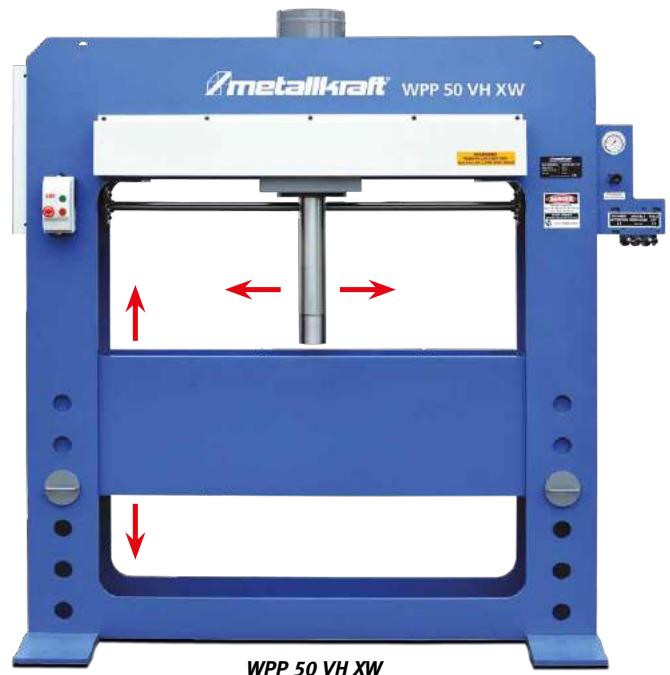
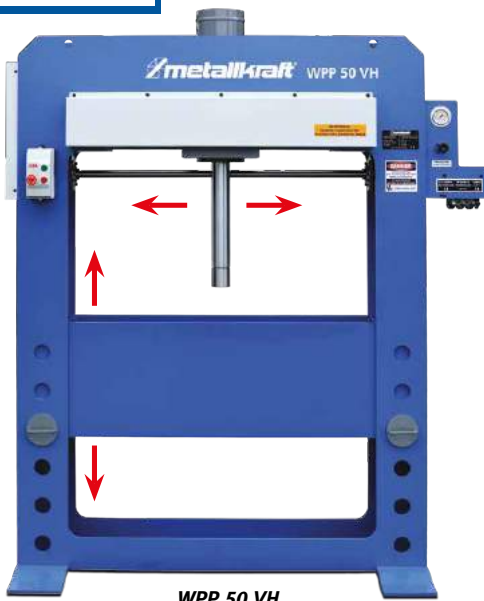

Scope of delivery:
 › Hydraulic oil HLP 46 Precis 20L
 (18 kg bucket) AGIP

Technical specifications		WPP 30 VH	WPP 50 VH	WPP 50 VH XW	WPP 100 VH	WPP 100 VH XW	WPP 200 VH	WPP 300 VH
Art. no.		4050030	4050050	4050055	4050100	4050105	4050200	4050300
Technical specifications								
Press force	t	30	50	50	100	100	200	300
Press speed	mm/s	6.1	6.5	6.5	6.7	6.7	1.3	1.4
Feed speed	mm/s	6.1	6.5	6.5	6.7	6.7	7.8	6.2
Return speed	mm/s	8.2	8.0	8.0	8.3	8.3	9.5	7.7
Motor output	kW	2.4	3.7	3.7	7.5	7.5	7.5	7.5
Power connection	V	400	400	400	400	400	400	400
Weight	kg	727	1 091	1 273	1 455	1 728	3 455	5 910
Dimensions								
A – Height of frame	mm	1 904	2 157	2 208	2 157	2 208	2 386	2 386
B – frame width	mm	1 371	1 624	2 030	1 624	2 030	2 132	2 132
C – Depth	mm	761	812	914	812	914	1 066	1 167
D – Clear width	mm	1 066	1 218	1 523	1 218	1 523	1 523	1 523
E – Depth of hole frame	mm	235	279	279	317	317	508	609
F – Clear height	mm	863	1 015	936	964	888	761	723
G – Piston stroke	mm	406	406	406	406	406	508	508
I – Cylinder stroke	mm	501	603	908	552	857	704	603
Pressing piston Ø	mm	63.5	76.2	76.2	101.6	101.6	126	152.4
Press piston projection length	mm	38.1	50.9	50.9	63.5	63.5	63.5	76.2
Hole spacing	mm	152	152	152	152	152	203	203
Bed (L x W)	mm	1 066 x 228	1 218 x 273	1 523 x 273	1 218 x 311	1 523 x 311	1 523 x 500	1 523 x 602
Inner diameter of perforated plate	mm	50	50	50	50	50	50	50



Quality
Made in
Canada

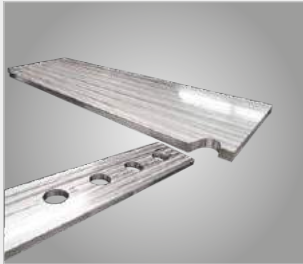

► The table, crown and legs are precision milled



► Premium hydraulic cylinder by Weber-Hydraulik



► Easily replaceable slide cap for various press applications.

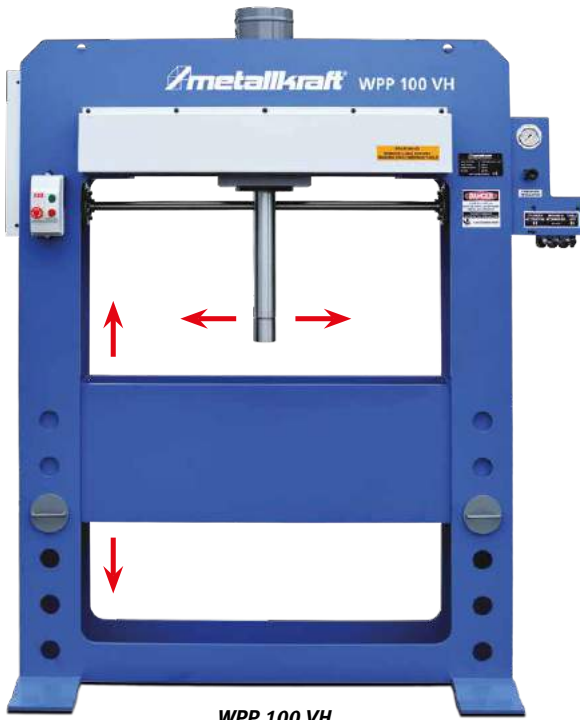

WPP 100 VH

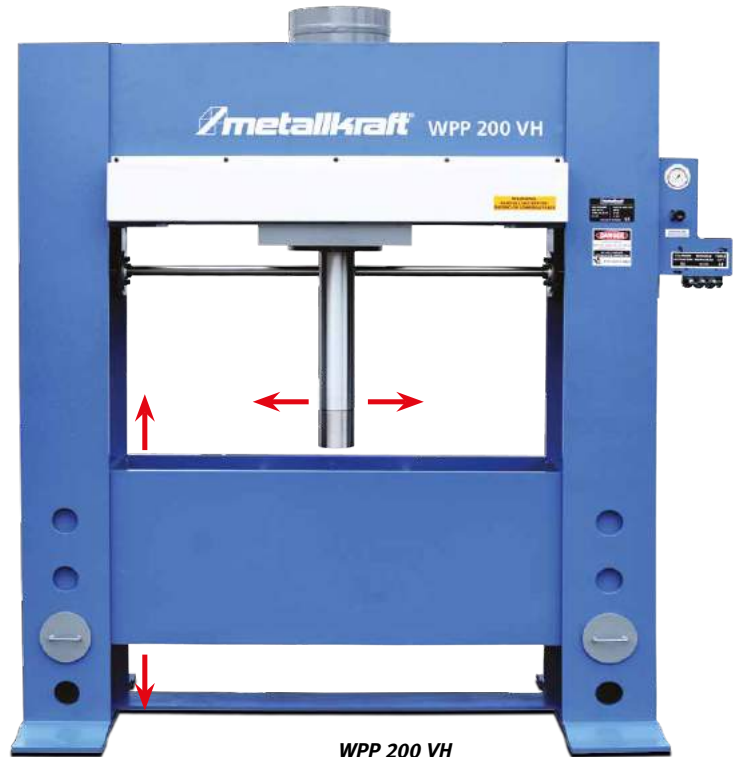

WPP 200 VH

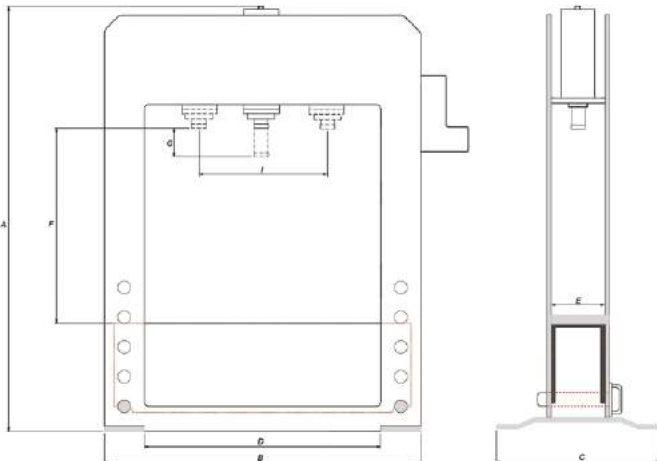

Accessories WPP 30 VH	Art. no.
Prism block set*	4060030
Protective grille	4062030
Pressure plate	4063030
Accessories WPP 50 VH	Art. no.
Prism block set*	4060050
Protective grille	4062050
Pressure plate	4063050
Accessories WPP 50 VH XW	Art. no.
Prism block set*	4060050
Protective grille	4062051
Pressure plate	4063051
Accessories WPP 100 VH	Art. no.
Prism block set*	4060100
Protective grille	4062100
Pressure plate	4063100
Accessories WPP 100 VH XW	Art. no.
Prism block set*	4060100
Protective grille	4062101
Pressure plate	4063101
Accessories WPP 200 VH	Art. no.
Prism block set*	4060200
Protective grille	4062200
Pressure plate	4063200
Accessories WPP 300 VH	Art. no.
Prism block set*	4060300
Protective grille	4062300
Pressure plate	4063300

* Set includes 2 prism blocks



Prism block set

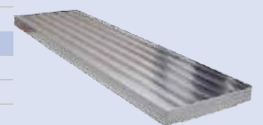

Pressure plate

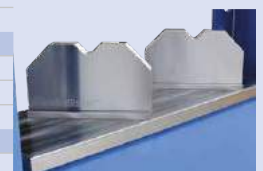

Thrust plate with prism block set

All hydraulic workshop press

WPP RP – All hydraulic workshop press for a flexible approach thanks to displaceable main cylinder and lateral broaching press



- ▶ For pressing bearings, bolts and bushings in and out, and for repair and assembly work, pressing work, load tests and weld sample testing, and much more.
- ▶ With pressure mandrel adapter for 2 different press diameters of the cylinder for various applications
- ▶ Pressing pressure can be read off on gauge
- ▶ Hydraulic control of the stroke and right/left motion of the cylinder, and height adjustment of the table
- ▶ Main cylinder laterally displaceable via lever
- ▶ Pressure-sensitive manual lever for controlling the feed speeds
- ▶ Combined with broaching
- ▶ The low-pressure hydraulic system keeps the oil temperature down to ensure greater efficiency and safe operation

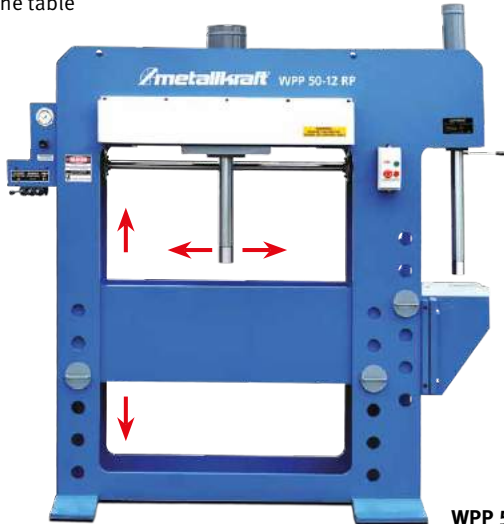

WPP 50-12 RP



▶ Pressure-sensitive manual lever and pressure gauge



▶ Laterally displaceable hydraulic cylinder



▶ Lateral broaching press with pressure gauge

Technical specifications		WPP 50-12 RP	WPP 100-20 RP
Art. no.		4051050	4051100

Scope of delivery:
 > Hydraulic oil HLP 46 Precis
 20L (18 kg bucket) AGIP

Technical specifications		WPP 50-12 RP	WPP 100-20 RP
Press force main press	T	50	100
Press force broaching press	T	12	20
Feed speed main press	mm/s	6.5	6.7
Feed speed broaching press	mm/s	10	10
Return speed main press	mm/s	8.0	8.3
Return speed broaching press	mm/s	32.8	55.7
Press speed main press	mm/s	6.5	6.7
Press speed broaching press	mm/s	10	10
Motor output	kW	3.7	7.5
Power connection	V	400	400
Weight	kg	1 409	1 864
Dimensions			
A – Height	mm	2 157	2 157
B – Overall width	mm	2 081	2 081
C – Depth	mm	812	812
D – Clear width	mm	1 218	1 218
F 1 – Clear height main press	mm	1 015	964
F 2 – Clear height broaching machine	mm	1 041	1 016
E – Depth of hole frame	mm	279	317
G 1 – Piston stroke main press	mm	406	406
G 2 – Outreach main press	mm	508	508
I – Cylinder stroke	mm	603	552
Table depth	mm	305	355
Piston Ø main press	mm	406	406
Piston Ø broaching machine	mm	508	508
Piston projection Ø main press	mm	50.8	63.5
Piston projection Ø broaching machine	mm	31.75	38.1
Hole spacing main press	mm	152	152
Bed (L x W) main press	mm	1 218 x 273	1 218 x 311
Bed (L x W) broaching machine	mm	273 x 330	311 x 330
Outside Ø press crown main press	mm	76.2	101.6
Press crown outside Ø	mm	50.8	63.5

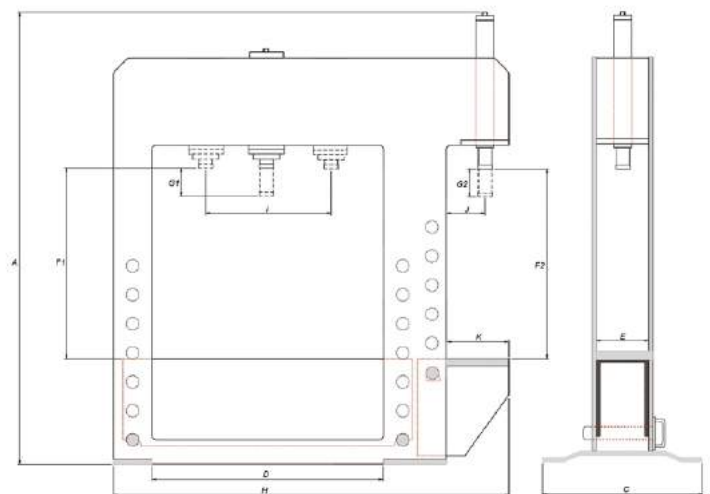

Accessories	Art. no.	Accessories	Art. no.
WPP 50-12 RP		WPP 100-20 RP	
Prism block set*	4060050	Prism block set*	4060100
Protective grille	4062900	Protective grille	4062901
* Set includes 2 prism blocks		Pressure plate	4063050

RFP – Hydraulic straightening press for eliminating deformations and torsion from metal workpieces



- ▶ With pressure mandrel adapter for 2 different press diameters of the cylinder for various applications
- ▶ Pressure-sensitive manual lever for controlling the feed speeds
- ▶ Large bed (508 mm x 2438 mm)



▶ Various crowns easily exchangeable



RFP 200



Scope of delivery:
 > Hydraulic oil HLP 46 Precis 20L
 (18 kg bucket) AGIP

New

Technical specifications		RFP 100	RFP 200
Art. no.		4054100	4054200
Technical specifications			
Press force	T	100	200
Press speed	mm/s	6.7	2
Feed speed	mm/s	6.7	8.5
Return speed	mm/s	8.3	10.3
Motor output	kW	7.5	7.5
Power connection	V	400	400
Weight	kg	3 750	5 818
Dimensions			
A – Height	mm	2 438	2 458
B – frame width	mm	2 438	2 438
C – Depth	mm	1 473	1 473
L - bed width	mm	508	508
K - bed depth	mm	2 438	2 438
G – Piston stroke	mm	406	508
M - installation height	mm	610	610
J - throat	mm	305	305
Piston Ø	mm	101.6	127
Piston projection Ø	mm	63.5	76.2
Piston projection length	mm	63.5	76.2
Bed (L x W)	mm	2 438 x 508	2 438 x 508
Press crown outside Ø	mm	101.6	127

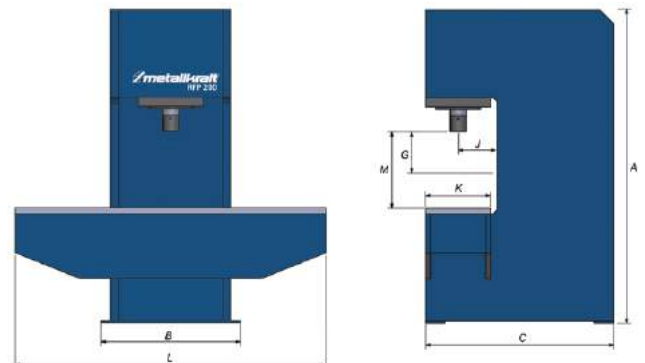

Accessories	Art. no.
RFP 200	
Prism block set*	4060200

* Set includes 2 prism blocks

metric drilling
Metal grinding
Cutting
Notching & punching
Bending
Presses
Circular saws
Roller conveyors
Metal-cutting band saws

All-hydraulic workshop presses

WPP RT – All hydraulic workshop press with moving bed for processing heavy and bulky workpieces



- ▶ For pressing bearings, bolts and bushings in and out, and for repair and assembly work, pressing work, load tests and weld sample testing, and much more.
- ▶ With pressure mandrel adapter for 2 different press diameters of the cylinder
- ▶ Hydraulic control of the stroke, right/left motion of the cylinder, cylinder TDC, and workpiece table motion
- ▶ Pressure-sensitive manual lever for controlling the feed speeds
- ▶ Cylinder laterally displaceable via lever
- ▶ Pressing pressure can be read off on gauge

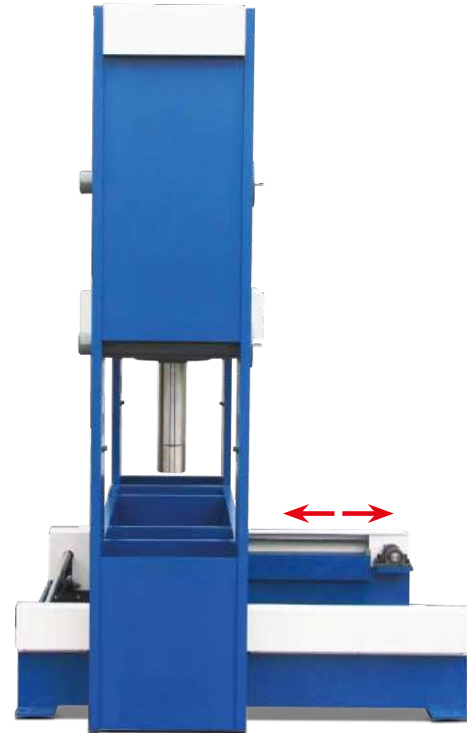
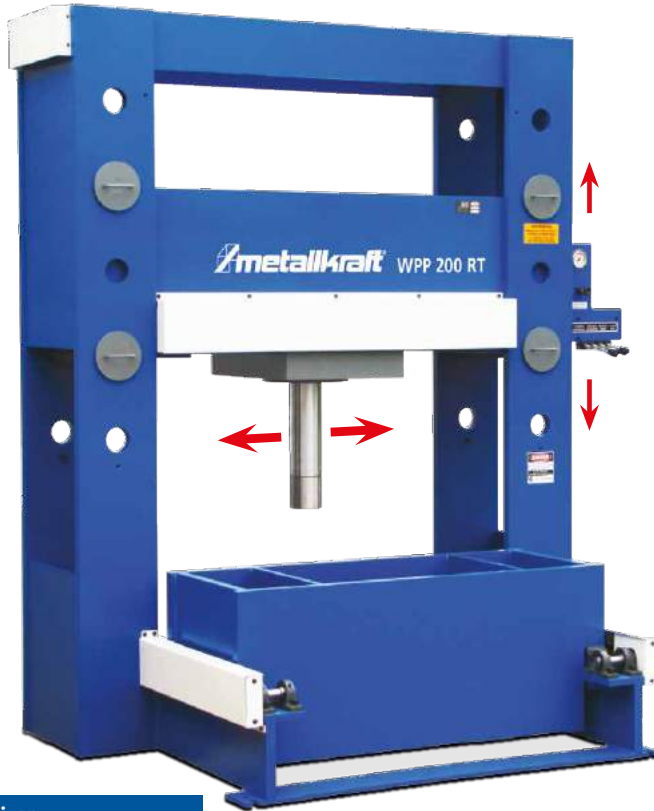

Scope of delivery:

- > Hydraulic oil HLP 46 Precis 20L (18 kg bucket) AGIP

Technical specifications	WPP 200 RT	
Art. no.	4053200	

Technical specifications		
Press force	T	200
Press speed	mm/s	2
Feed speed	mm/s	8.5
Return speed	mm/s	10.3
Work table motion speed	mm/s	10
Motor output	kW	7.5
Power connection	V	400
Weight	kg	4 545
Dimensions		
A – Height	mm	2 709
B – frame width	mm	2 134
C – Depth	mm	1 777
D – Clear width	mm	1 523
E – Depth of hole frame	mm	514
F – Clear height	mm	787
G – Piston stroke	mm	508
I – Cylinder stroke	mm	704
K – bed depth	mm	590
N – Working height	mm	679
O – Bed stroke	mm	730
Piston Ø	mm	127
Piston projection Ø	mm	76.2
Piston projection length	mm	76.2
Hole spacing	mm	305
Bed length/width (J x K)	mm	1 523 x 590
Press crown outside Ø	mm	127

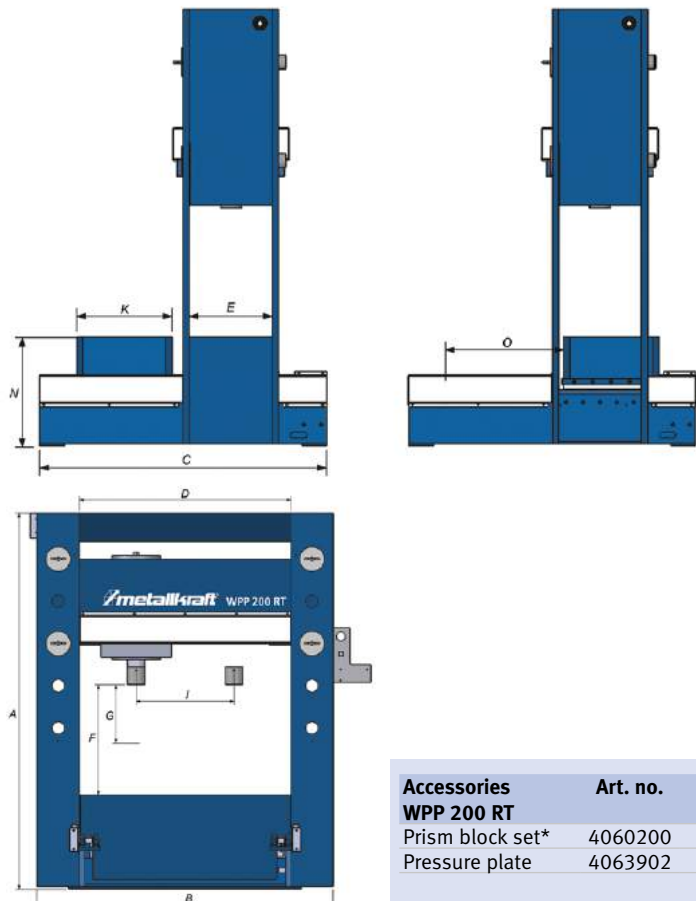

Accessories	Art. no.
WPP 200 RT	
Prism block set*	4060200
Pressure plate	4063902

* Set includes 2 prism blocks

All hydraulic tyre press

RPP – All hydraulic tyre press for mounting rubber tyres and normal press work in the workshop



RPP 150 + RPP 150 RI

- ▶ Hydraulic control of the cylinder stroke and height adjustment of the bed by 406 mm
- ▶ Pressure-sensitive manual lever for controlling the feed speeds
- ▶ Excellent stability of the mounting plate thanks to large cylinder
- ▶ Dual-action cylinder for controllable feed and reverse motion

- ▶ Pressing pressure can be read off on gauge
- ▶ Pressure regulator for limiting the back pressure

RPP 150 RI

- ▶ Hydraulic bed motion control for easy loading and unloading outside of the press area



RPP 150

RPP 150 RI

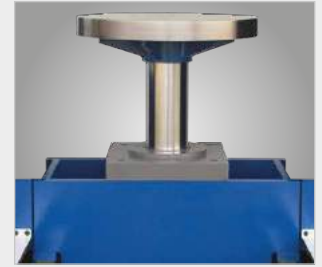

▶ Large, powerful hydraulic cylinder



▶ Large mounting plate



▶ Pressure-sensitive manual lever and pressure gauge

Scope of delivery:

- ▶ Hydraulic oil HLP 46 Precis 20L (18 kg bucket) AGIP

Technical specifications		RPP 150	RPP 150 RI
Art. no.		4052150	4052155

Technical specifications		RPP 150	RPP 150 RI
Press force	T	150	150
Press speed	mm/s	2.1	2.1
Feed speed	mm/s	3	3
Return speed	mm/s	3	3
Motor output	kW	3.7	3.7
Power connection	V	400	400
Weight	kg	2 091	2 364
Dimensions			
A – Height	mm	2 437	2 405
B – Width (without pump)	mm	1 320	1 320
D – Depth (with base)	mm	1 117	1 523
G – Depth of hole frame	mm	419	381
Piston diameter	mm	152	152
Hole spacing	mm	203	203
Piston stroke	mm	304	304
Bed Ø	mm	634	634

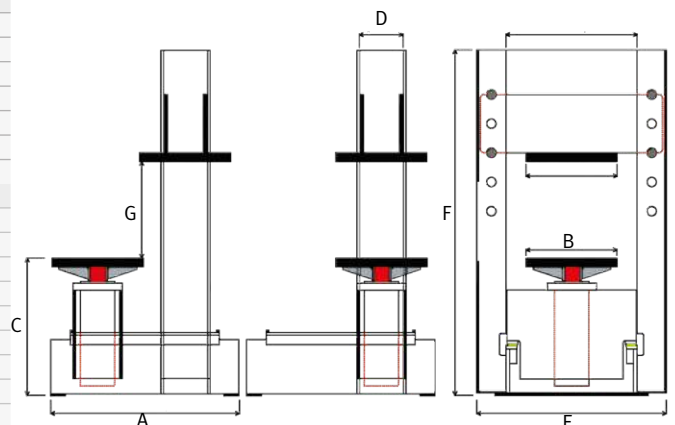

Magnetic drilling
Deburring
Metal grinding
Cutting
Notching & punching
Bending
Presses
Circular saws
Roller conveyors
Metal-cutting band saws

Frame presses

RP U – Universally deployable thanks to equipping with individual bending, pressing, embossing, straightening or cutting tools

- ▶ Very heavy-duty and durable welded structure
- ▶ Reinforced top beam to safeguard the unit is in parallel
- ▶ Large support surface with T grooves and central bore
- ▶ Large ramming plate with T grooves
- ▶ Top and bottom end position of the piston stroke can be adjusted continuously using cams
- ▶ Pressure can be adjusted continuously
- ▶ Pressure gauge shows pressing pressure
- ▶ Height-adjustable worktop
- ▶ Device to adjust the table height
- ▶ Two-hand operation and foot pedal
- ▶ Hydraulic operation

Can we help you?

Your local specialist retailer is more than happy to help you with any issues. We will also be more than happy to support you and provide you with a list of specialist retailers where you are;
contact: +49(0)951 96555-171
beratung@metalkraft.de



Fig. shows RP U 1520-150

Technical specifications		RP U 1020-100	RP U 1520-100	RP U 1020-150	RP U 1520-150
Art. no.		4021010	4021510	4021015	4021515
Technical specifications					
Press force	T	100			150
Working width	mm	1 020	1 520	1 020	1 520
Piston stroke	mm		300		
Min. installation height	mm	325			275
Max. installation height	mm	680			610
Hole distance for table adjustment	mm			190	
Rapid traverse	mm/s			9	
Pressing mode	mm/s			5	
Retraction	mm/s			10	
Table size	mm	500 x 1 020	500 x 1 520	600 x 1 020	600 x 1 520
Table bore Ø	mm			100	
Motor output	kW	7.5			11
Length	mm	2 110	2 630	2 110	2 630
Width	mm		1 000		
height	mm	2 275			2 450
Weight	kg	1 900	2 500	2 400	3 100

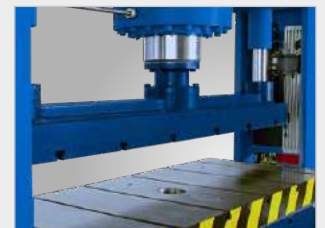

RP A – frame press with unit to bend edges

- ▶ Very heavy-duty and durable welded structure
- ▶ Reinforced top beam to safeguard the unit is in parallel
- ▶ Cranked tool at the top
- ▶ 5x die with V openings 10, 20, 30, 40 and 65 mm (see page 171 for press force table)
- ▶ Top and bottom end position of the piston stroke can be adjusted continuously using cams
- ▶ Suitable to bend edges on very thick plates, bending long sheet metal panels and calibrating plates
- ▶ Pressure can be adjusted continuously
- ▶ Pressure gauge shows pressing pressure
- ▶ Height-adjustable worktop
- ▶ Two-hand operation and foot pedal
- ▶ Hydraulic operation



Fig. shows RP A 1520-150

Technical specifications		RP A 1020-100	RP A 1520-100	RP A 1020-150	RP A 1520-150
Art. no.		4021611	4021651	4021615	4021655
Technical specifications					
Press force	T		100		150
Working width	mm	1 020	1 520	1 020	1 520
Piston stroke	mm			300	
Min. installation height	mm		325		275
Max. installation height	mm		680		610
Hole distance for table adjustment	mm			190	
Rapid traverse	mm/s			9	
Pressing mode	mm/s			5	
Retraction	mm/s			10	
Table size	mm		500 x 1 020		600 x 1 020
Table bore Ø	mm			100	
Motor output	kW		7.5		11
Length	mm	2 110	2 630	2 110	2 630
Width	mm			1 000	
height	mm		2 275		2 450
Weight	kg	1 900	2 500	2 400	3 100

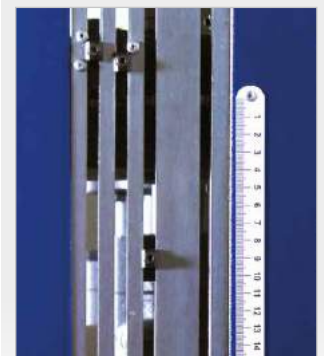

RP A	Art. no.	€ plus VAT
Custom tools	On request	On request

C upright presses

HP C – Bending, embossing, punching and pressing with individual tools

- ▶ Operated using a mobile, two-hand control panel
- ▶ Top beam reinforced four times
- ▶ Bed and slide plate with T grooves to attach equipment and tools
- ▶ Continuously adjust the pressure
- ▶ Pressure gauge to read out the adjusted pressing force

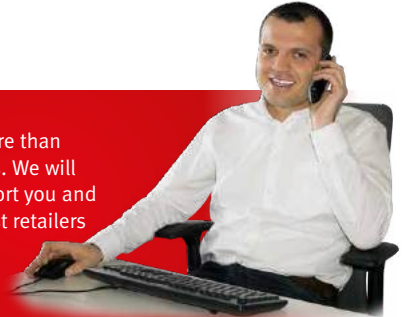

Fig. shows HP C 100

Can we help you?

Your local specialist retailer is more than happy to help you with any issues. We will also be more than happy to support you and provide you with a list of specialist retailers where you are;

contact: +49(0)951 96555-171
beratung@metallkraft.de



Machines with higher speeds, larger beds and slide plates as well as drawing cushions on request

Technical specifications	HP C 30	HP C 60	HP C 100	HP C 150
Art. no.	4022030	4022060	4022100	4022150
€ plus VAT	upon request	upon request	upon request	upon request

Scope of delivery:

- > Mobile control panel
- > Hydraulic operation

Technical specifications	HP C 30	HP C 60	HP C 100	HP C 150
Press force	30 t	60 t	100 t	150 t
Piston stroke	200 mm	250 mm	300 mm	300 mm
Rapid traverse	54 mm/s	26 mm/s	17.5 mm/s	10 mm/s
Pressing mode	18 mm/s	8.5 mm/s	5.5 mm/s	3.5 mm/s
Return side	90 mm/s	47 mm/s	37 mm/s	22 mm/s
Installation height	400 mm	450 mm	500 mm	500
Table size	450 x 700 mm	500 x 750 mm	700 x 1 100 mm	700 x 1 100 mm
Slide plate size	380 x 500 mm	430 x 500 mm	420 x 680 mm	500 x 750 mm
Hole Ø in the centre of the table	80 mm	100 mm	120 mm	120 mm
Motor output	7.5 kW	7.5 kW	7.5 kW	7.5 kW
Length	1 880 mm	1 820 mm	1 935 mm	2 300 mm
Width	850 mm	960 mm	1 300 mm	1 400 mm
height	2 250 mm	2 400 mm	2 750 mm	2 750 mm
Weight	3 400 kg	4 000 kg	5 400 kg	7 700 kg
Transport packaging flat rate*	TPFR 6 = €200.00	TPFR 6 = €200.00	TPFR 6 = €200.00	TPFR 6 = €200.00

* Please turn over for descriptions of the packaging surcharges, data on TPFR excluding VAT.

Model range overview

Metal-cutting circular saws and metal-cutting band saws

- ▶ The following pages provide an overview of all Metalkraft circular saws, metal-cutting band saws, and horizontal band saws.

Based on the coloured marking, you can see at a glance if the saw is manual, semi-automatic or automatic.

Explanation of the colour scheme:

Manual

Semi-automatic

Automatic

Metalkraft saw bands

- ▶ You will find an overview of our saw bands on Page 283 of this catalogue. This is also where you will find information on the fundamental dos and don'ts of sawing.
- ▶ Of course, you will always find the matching saw bands on offer along with the individual machines.
- ▶ We are always happy to perform sample cutting for your special material.

- ▶ Call us for details!

Important information:

- ▶ Please note the instructions prefixed with these exclamation marks; they point to in-depth information.



Roller conveyors and accessories

- ▶ Naturally, we also offer a large range of roller conveyors and accessories for our saws.
- ▶ You will find them in the catalogue right next to the individual machines.
- ▶ We are always happy to give you advice on the right configuration for your task.

HKS 230



Clamping ranges HSK 230

	○	□	▭
90°	-	82	-
45°	-	56	-
60° +	-	-	-

MTS 356



Clamping ranges MTS 356

	○	□	▭
0°	132	120 x 120	100 x 180
39°, left	105	90 x 90	120 x 90
45°, right	105	90 x 90	120 x 90

MKS 250 N



Cutting capacity MKS 250 N

	●	○	□	▭
0°	40	70	70 x 70	55 x 95
45°/45°	35	65	60 x 60	50 x 65

MKS 255 N



Cutting capacity MKS 255 N

	●	○	□	▭
0°	40	70	70 x 70	55 x 95
45°/45°	35	65	55 x 55	55 x 60

MKS 275 N



Cutting capacity MKS 275 N

	●	○	□	▭
0°	45	65	65 x 65	85 x 60
45°/45°	40	60	40 x 40	40 x 60

MKS 315 N



Cutting capacity MKS 315 N

	●	○	□	▭
0°	55	90	80 x 80	70 x 115
45°/45°	50	80	70 x 70	70 x 70

Saw overview

MKS 315 R / 316 R



Cutting capacity MKS 315 R / 316 R

	●	○	□	▭
0°	65	90	85 x 85	70 x 120
45°/45°	60	80	70 x 70	70 x 80

MKS 350 / MKS 351



Cutting capacity MKS 350 / MKS 351 / MKS 350 H

	●	○	□	▭
0°	60	110	100 x 100	80 x 120
45°/45°	55	80	80 x 80	80 x 80

MKS 350 H



MKS 315 V / MKS 316 V



Cutting capacity MKS 315 V, 316 V

	●	○	□	▭
0°	70	100	90 x 90	80 x 135
45°	70	100	90 x 90	80 x 100
45°/45°	70	100	90 x 90	80 x 100
60°	70	80	70 x 70	70 x 70

MKS 350 V



Cutting capacity MKS 350 V

	●	○	□	▭
0°	100	120	100 x 100	90 x 170
45°	100	120	90 x 90	90 x 125
45°/45°	100	120	90 x 90	90 x 125
60°	90	90	90 x 90	90 x 90

MKS 315 VH / MKS 350 VH



Cutting capacity MKS 315 VH

	●	○	□	▭
0°	70	100	90 x 90	80 x 135
45°	70	100	90 x 90	80 x 100
45°/45°	70	100	90 x 90	80 x 100
60°	70	80	70 x 70	70 x 70

MKS 315 VA



Cutting capacity MKS 315 VA

	●	○	□	▭
0°	70	100	90 x 90	80 x 120
45°	70	90	80 x 80	80 x 80
45°/45°	70	90	80 x 80	80 x 80
60°	70	80	70 x 70	80 x 70

MKS 350 VH



Cutting capacity MKS 350 VA

	●	○	□	▭
0°	100	130	120 x 120	100 x 170
45°/45°	100	130	110 x 110	100 x 140

LMS 400



LMS 400 H



LMS 400 P







Cutting capacity LMS 400 / LMS 400 H / LMS 400 P

	●	○	□	▭
0°	60	140	110 x 110	100 x 180
45°/45°	60	130	100 x 100	100 x 150

MKS 315 R / 316 R





Cutting capacity LMS 400 A

			
60	140	110 x 110	100 x 180



ULMS 420 / ULMS 500



Cutting capacity ULMS 420

	
135 x 135	
	
125 x 125	



Cutting capacity ULMS 500

	
170 x 170	
	
160 x 160	



MBS 105, MBS 125, MBS 150 / MBS 155 K





Clamping ranges MBS 105

			
90°	105	101	101 x 105
45°	70	70	70 x 70
45° +	-	-	-

Clamping ranges MBS 125

			
90°	125	125	130 x 125
45°	80	80	80 x 80
45° +	50	50	50 x 50







Clamping ranges MBS 150 / MBS 155 K

			
90°	150	140	150 x 140
45°	100	90	100 x 90
45° +	70	65	65 x 70

BMBS 220 x 250 H-G



Clamping ranges BMBS 220 x 250 H-G









mm				
	0°	45°	60°	$\frac{b}{a \times b}$
	220	160	90	X
	120*	85*	55*	X
	230 x 190	160 x 90	90 x 90	230 x 120

* recommended values

BMBS 230 x 280 H-DG



Clamping ranges BMBS 230 x 280 H-DG









mm					
	0°	45°	60°	45°	$\frac{b}{a \times b}$
	230	190	125	185	X
	150*	110*	80*	110*	X
	280 x 180	180 x 170	120 x 110	180 x 120	120 x 180

* recommended values

BMBS 230 x 280 HA-DG



Clamping ranges BMBS 230 x 280 HA-DG / BMBS 230 x 280 CNC

mm					
	0°	45°	60°	45°	$\frac{b}{a \times b}$
	230	190	125	185	X
	150*	110*	80*	110*	X
	280 x 180	180 x 170	120 x 110	180 x 120	120 x 180

* recommended values

BMBS 230 x 280 CNC



Saw overview

BMBS 250 x 315 H-DG



BMBS 250 x 315 HA-DG



BMBS 300 x 320 H-DG



Clamping ranges BMBS 250 x 315 H-DG / 250 x 315 HA-DG

mm	□ 0°	▤ 45°	▥ 60°	▧ 45°	▨ ^a b
○	250	190	120	170	-
●	150*	110*	80*	110*	-
▭	290 x 200	190 x 140	120 x 140	200 x 70	200 x 120

* recommended values

Clamping ranges BMBS 300 x 320 H-DG

mm	□ 0°	▤ 45°	▥ 60°	▧ 45°	▨ ^a b
○	300	300	200	280	-
●	180*	110*	80*	110*	-
▭	320 x 300	305 x 250	200 x 200	260 x 200	230 x 160

* recommended values

BMBS 300 x 320 HA-DG



BMBS 300 x 320 CNC-G



Clamping ranges BMBS 300 x 320 HA-DG

mm	□ 0°	▤ 45°	▥ 60°	▧ 45°	▨ ^a b
○	300	300	200	240	X
●	180*	110*	80*	110*	X
▭	320 x 300	300 x 250	200 x 200	260 x 200	230 x 120

* recommended values

Clamping ranges BMBS 300 x 320 CNC-G

mm	□ 0°	▤ 45°	▥ 60°	▨ ^a b a x b
○	300	300	200	X
●	180*	110*	80*	X
▭	320 x 300	300 x 250	200 x 200	230 x 120

* recommended values

BMBS 360 x 500 HA-DG



BMBS 360 x 500 CNC-G



BMBS 460 x 600 HA-DG



Clamping ranges BMBS 360 x 500 HA-DG

mm	□ 0°	▤ 45°	▥ 60°	▧ 45°	▨ 60°	▨ ^a b
○	360	350	270	360	310	X
●	250*	180*	130*	180*	130*	X
▭	500 x 360	400 x 180	270 x 320	400 x 190	310 x 170	500 x 220

* recommended values

Clamping range BMBS 360 x 500 CNC-G

mm	□ 0°	▤ 45°	▥ 60°	▨ ^a b a x b
○	360	360	300	X
●	250*	180*	130*	X
▭	500 x 340	440 x 220	310 x 220	500 x 220

* recommended values

Clamping ranges BMBS 460 x 600 HA-DG





mm	□ 0°	▤ 45°	▥ 60°	▧ 45°	▨ 60°	▨ ^a b
○	460	460	320	460	320	X
●	400*	280*	200*	280*	190*	X
▭	600 x 460	490 x 200	340 x 160	470 x 220	320 x 220	610 x 250

* recommended values

HMBS 340 CNC-DG-X



Clamping ranges HMBS 340 CNC-DG-X

mm	□ 0°	▤ 45°	▥ 60°	▧ 45°
	350	350	230	350
	250	180*	130*	180*
	500x340	385x340	220x340	390x340
	340x340	340x340	340x220	340x340





* recommended values

HMBS 500 x 750 HA-DG



HMBS 500 x 750 HA-DG X

Clamping ranges HMBS 500 x 750 HA-DG (X)





mm	□ 0°	▤ 45°	▥ 60°	▧ 45°	▧ 60°	
	500	500	330	500	300	X
	400 *	280 *	200 *	280 *	190 *	X
	750x480	500x480	330x480	500x480	300x480	750x260

* recommended values

HMBS 300 x 300 CNC X



Clamping ranges HMBS 300 x 300





mm	□ 0°	
	300	X
	250 *	X
	300 x 300	300 x 220

* recommended values

HMBS 400 CNC



Clamping ranges HMBS 400 CNC





mm	□ 0°	
	410	X
	250 *	X
	400 x 400	400 x 340

* recommended values

HMBS 400 x 400 CNC X



Clamping ranges HMBS 400 x 400





mm	□ 0°	
	400	X
	400 *	X
	400 x 400	400 x 250

* recommended values

HMBS 510 x 510 CNC X



Clamping ranges 510 x 510 CNC X

mm	□ 0°	
	510	X
	510 *	X
	510 x 530	500 x 450

* recommended values

Saw overview

HMBS 5000 CNC X



Clamping ranges

mm	0°	$\frac{b}{a}$
	550	x
	550*	x
	550 x 620	550 x 350
	550 x 550	x

* recommended values

HMBS 700 x 750 HA X



Clamping ranges HMBS 700 x 750 HA X

mm	0°	$\frac{b}{a}$
	700	x
	700*	x
	750 x 700	750 x 450

* recommended values

HMBS 5000 CNC X



Clamping ranges HMBS 700 x 750 CNC X

mm	0°	$\frac{b}{a}$
	700	x
	700*	x
	750 x 700	750 x 450

* recommended values

HMBS 5000 CNC X



Clamping ranges HMBS 700 x 750 CNC X

mm	0°	$\frac{b}{a}$
	700	x
	700*	x
	750 x 700	750 x 450

* recommended values

HMBS 850 x 1000 HA X-VS



Clamping ranges

mm	0°	$\frac{b}{a}$
	850	x
	850	x
	850 x 850	850 x 610

* recommended values

HVMB 850 x 1000 Xtreme
HVMB 1200 x 1600 Xtreme

Clamping ranges

mm	0°
	850
	1 000 x 850
	2 000 x 850



Clamping ranges

mm	0°
	1 200
	1 600 x 1 200
	1 600 x 3 000



VMBS



VMBS	1408	1610	1610 E	2012 E	2012HE	2613	2613E	3612	3612E
Throat	356 mm	396 mm	396 mm	508 mm	508 mm	658 mm	658 mm	915 mm	915 mm
max. cutting height	205 mm	255 mm	255 mm	305 mm	305 mm	330 mm	330 mm	305 mm	305 mm



Important notice

We exclusively use steam-treated saw blades (HSS DM 05).

What does steam treatment achieve? Steaming at 500°C achieves controlled oxidisation. A ferric oxide layer (Fe_3O_2) is created on the surface of the saw blades, thus improving the sliding quality while at the same time protecting against corrosion. Additionally, internal stresses in the blade are eliminated, thus reducing the risk of breakage and significantly improving the service life. This is why you should always order saw blades by METALLKRAFT.

Metal-cutting circular saw, manual/Metal dry cutter

HKS 230 – Metal hand-held circular saw for workshops and building sites when cutting aluminium, steel and stainless steel

- ▶ The ideal machine for assembly shops, facade builders, locksmiths, repair workshops, trade fair constructors etc.
- ▶ Ideal for applications where angle grinders are not strong enough or cannot work cleanly
- ▶ Cuts stainless steel without burrs
- ▶ Cuttings conduct the heat away, hence only low heat formation during cutting
- ▶ Highly resilient motor with soft start and overload protection
- ▶ Immersion in the material possible
- ▶ Uncomplicated and rapid cutting depth setting based on a precise and easy-to-read scale
- ▶ Stable and robust structure
- ▶ Handle can be screwed in at two different positions for convenient handling of the saw in any position
- ▶ Easy to use



▶ Rapid saw blade change by gear locking pin



▶ Uncomplicated and rapid cutting depth setting based on a precise and easy-to-read scale

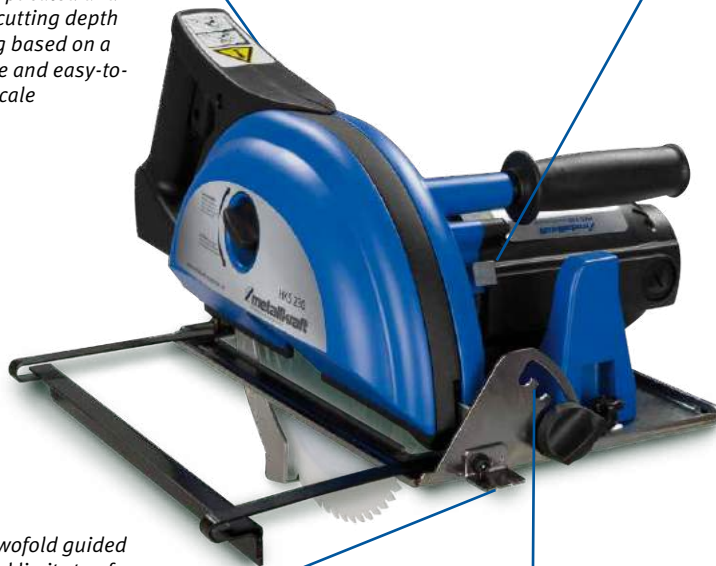

▶ With twofold guided parallel limit stop for exact cut guidance



▶ Continuously adjustable and convenient setting of the mitre angle; grid division at 0°, 15°, 30° and 45°

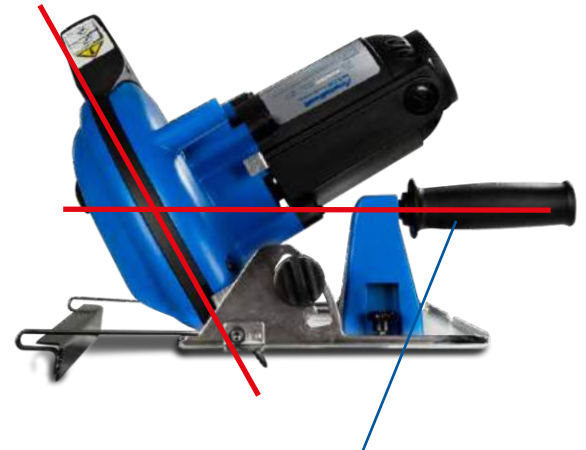

▶ Handle can be converted so that the saw can be safely guided parallel to the cutting plane

Model	HKS 230 *
Art. no.	3840231

Technical specifications	
Motor output 230 V / 50 Hz	1.7 kW
Speeds	2 220 rpm
Cutting range 90° □ / Wall thickness	80 mm
Cutting range 45° □ / Wall thickness	56 mm
Max. saw blade diameter	Ø 230 mm
Saw blade bore	Ø 25.4 mm
Saw blade thickness	2 mm
Dimensions (LxWxH)	620 x 320 x 270 mm
Weight	7.1 kg

* Machine is supplied in sturdy plastic case without saw blade

Saw blades specially designed for the machines and the specific applications:



Saw blades Ø 230 x 25.4 mm	Blade thickness	Number of teeth	Art. no.
Steel	2.0 mm	48	3850231
Aluminium	2.4 mm	80	3850232
Stainless steel	1.8 mm	60	3850233

MTS 356 – Metal dry cutter, sawing metal without coolant

- ▶ Extremely stable and robust structure
- ▶ Easy to transport
- ▶ For virtually burr-free sawing of sections and pipes made of steel, iron, copper, brass, aluminium, plastics, composite materials and stainless steel, without needing a coolant
- ▶ For use in metalworking, carpentry, interior fitting, etc.
- ▶ Soft-start motor for easier handling on

- ▶ switching on the saw
- ▶ Includes prism clamping jaws for clamping pipes as standard equipment
- ▶ Easily adjustable clamps
- ▶ Stable thanks to die-cast aluminium feet
- ▶ Angle for mitre cuts
- ▶ right 45°, left 39°
- ▶ With length stop for precise cutting
- ▶ With spindle lock for easy saw blade

replacement

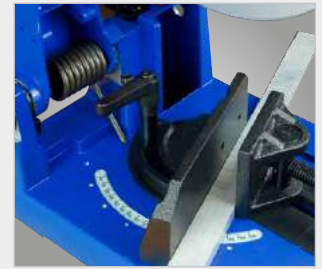

- ▶ Mitre angle easy to read off the scale
- ▶ Vice continuously adjustable swivel from right 45°, left 39°
- ▶ Easily adjustable clamps



Chassis
foldable
Art no. 3630000

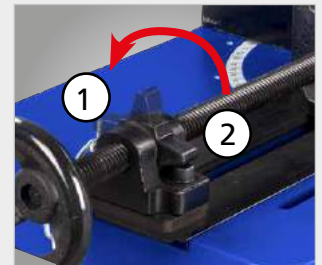

- ▶ Saw equipped with quick-release vice, by changing over the toggle lever between the quick-release (Pos. 1) and clamping (Pos. 2)

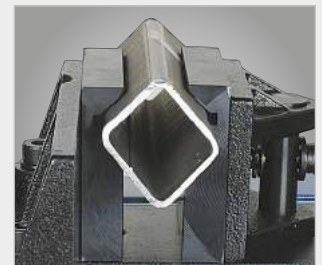

- ▶ Prism vice for pipes
- ▶ (second prism jaws optional, art. no. 3850355)

- Scope of delivery:**
- > 4, 6 and 8 mm Allen key
 - > Protective eyewear
 - > 1 Prism clamping jaw
 - > Without saw blade



Prism clamping jaw
1 piece included in
scope of supply

Model		MTS 356
Art. no.		3840355

Technical specifications		
Motor output 230 V / 50 Hz		2.2 kW
Speeds		1 300 rpm
Cutting range 0°	<input type="checkbox"/>	100 x 180 mm (H x W)
Cutting range 0°	<input type="checkbox"/>	120 x 120 mm
Cutting range 0°	<input type="checkbox"/>	132 mm
Cutting range right 45°, left 39°	<input type="checkbox"/>	120 x 90 mm (H x W)
Cutting range right 45°, left 39°	<input type="checkbox"/>	90 x 90 mm
Cutting range right 45°, left 39°	<input type="checkbox"/>	105 mm
Saw blade diameter		Ø 355 mm
Weight		23.5 kg



Accessories	Number of teeth	Art. no.
Chassis MTS 356		3630000
Prism clamping jaw		3850355
Saw blades Ø 355 x 2.4 x 25.4 mm		
- Steel	80	3853504
- Aluminium	80	3853502
Saw blades Ø 305 x 2.4 x 25.4 mm		
- Steel	60	3853051

Magnetic drilling
Deburring
Metal grinding
Cutting
Notching & punching
Bending
Presses
Circular saws
Roller conveyors
Metal-cutting band saws

Metal-cutting circular saws

Manual metal-cutting circular saws with one and two speeds, and swivelling saw head and vice for mitre cuts

- ▶ For steel
- ▶ Two cutting speeds
- ▶ Reduction gear, runs in oil bath for low noise
- ▶ Automatic diaphragm coolant pump with coolant filter as standard
- ▶ moving guard ensures optimum safety while cutting
- ▶ Control handle with safety switch
- ▶ Low-voltage electrical system, 24 Volt, with emergency off switch, main switch, speed selection switch and overload protection
- ▶ Swivels from -45° to +45°
- ▶ Machine head swivels through 45° anti-clockwise and 45° clockwise
- ▶ Vice swivels through 45° anti-clockwise and 45° clockwise
- ▶ Quick release vice with double clamping device guarantees precise and virtually burr-free cutting



MKS 250 N
Standard scope of supply



MKS 255 N
▶ Double vice, swivelling from -45° to +45° with quick release

Scope of delivery:

- › Coolant system
- › Cross-cut fence 500 mm
- › Operating tool
- › Without saw blade
- › without chassis

Model	MKS 250 N	MKS 255 N	MKS 275 N
Art. no.	3620251	3620253	3620275
Technical specifications			
Motor output 50 Hz	1.1 kW / 230 V	0.95 - 1.32 kW / 400 V	1.1 - 1.5 kW / 400 V
Speeds	40 - 80 rpm	40 - 80 rpm	40 - 80 rpm
Vice jaw width	100 mm	100 mm	105 mm
Saw blade diameter	Ø 250 mm	Ø 250 mm	Ø 275 mm
Run-in height incl. chassis	970 mm	970 mm	970 mm
Dimensions (L x W x H)	800 x 830 x 755 mm	800 x 830 x 755 mm	830 x 900 x 1 025 mm
Weight	91 kg	94 kg	98 kg

Cutting capacity MKS 250 N

	●	○	□	▭
0°	40	70	70 x 70	55 x 95
45°/45°	35	65	60 x 60	50 x 65

Cutting capacity MKS 255 N

	●	○	□	▭
0°	40	70	70 x 70	55 x 95
45°/45°	35	65	55 x 55	55 x 60

Cutting capacity MKS 275 N

	●	○	□	▭
0°	45	65	65 x 65	85 x 60
45°/45°	40	60	40 x 40	40 x 60

Cutting capacity MKS 275 N optionally with saw blade 315 N

	●	○	□	▭
0°	45	80	80 x 80	100 x 70
45°/45°	40	80	70 x 70	80 x 70



MKS 275 N

MKS 275 N
Scope of delivery:

- > Coolant system
- > Cross-cut fence 500 mm
- > Operating tool
- > Without saw blade
- > without chassis



- ▶ Quick release vice swivelling through 45° anti-clockwise and 45° clockwise

Micro-dosing unit standard equipment
Universally deployable for minimal lubrication of
tool blades and forming tools

- ▶ Separate air and spraying agent lines avoid dripping

- ▶ With extra large lubricant tank, frequency-controlled pump and spray head

Micro-dosing unit MD 11

- ▶ For circular saws and metal-cutting band saws

Micro-dosing unit MD 12, special features

- ▶ Filter pressure regulator with water separator
- ▶ Robust sheet steel housing
- ▶ Coaxial hose with flexible steel jacket



MD 11



MD 12

Accessories

	Art. no.
Machine chassis MKS 250 N/255 N/275 N	3642571
Coolant concentrate 5 l	3601751
Spraying agent 5 l, micro-dosing unit	3608020
Micro-dosing unit MD 11 - 24V AC	3608011
Micro-dosing unit MD 12 - 24V AC	3608012
Micro-dosing unit assembly	9002000

Saw blades MKS 250/255 N

HSS saw blade DM05 Ø250x2x32 mm t4 ¹⁾	3652504
HSS saw blade DM05 Ø250x2x32 mm t6 ¹⁾	3652506

Saw blades MKS 275 N

HSS saw blade DM05 Ø275x2.5x32 mm t4 ¹⁾	3652754
HSS saw blade DM05 Ø275x2.5x32 mm t6 ¹⁾	3652756
HSS saw blade DM05 Ø275x2.5x32 mm t8 ¹⁾	3652758

¹⁾t = tooth spacing ²⁾Price without installation on the saw



Chipmag swarf remover

- ▶ magnetic Art. no. 3850010

Metal-cutting circular saws

Manual metal-cutting circular saws with 315 mm saw blade, one and two speeds, and swivelling saw head and vice for mitre cuts



- ▶ two cutting speeds
- ▶ swivelling machine head by 45° anti-clockwise and 45° clockwise
- ▶ Reduction gear running in oil bath
- ▶ automatic diaphragm coolant pump with coolant filter as standard
- ▶ Quick release vice with burr-prevention unit, swivelling through 45° anti-clockwise and 45° clockwise

- ▶ Vice longitudinally displaceable, and thus suitable for longitudinal cutting and slotting
- ▶ moving guard ensures optimum safety while cutting
- ▶ Control handle with safety switch
- ▶ Low-voltage electrical system, 24 Volt, with emergency off switch, main switch, speed selection switch and overload protection

Equipment MKS 315 R / MKS 316 R

- ▶ with adjustable slip clutch, thus ruling out breaking of the saw blade
- ▶ **MKS 316 R low-speed, and thus perfect for working with stainless steel**



▶ Quick release vice swivelling through 45° anti-clockwise and 45° clockwise



MKS 315 N

Scope of delivery MKS 315 N:

- > Coolant system
- > Cross-cut fence 500 mm
- > Operating tool
- > **Without saw blade**
- > **Without chassis**

MKS 315 R / MKS 316 R

Scope of delivery MKS 315 R / MKS 316 R:

- > Coolant system with filter
- > Material support arm with roller
- > Cross-cut fence 500 mm
- > Operating tool
- > **Without saw blade**
- > **Without chassis**

Cutting capacity MKS 315 N

	●	○	□	▭
0°	55	90	80 x 80	70 x 115
45°/45°	50	80	70 x 70	70 x 70

Cutting capacity MKS 315 R / 316 R

	●	○	□	▭
0°	65	90	85 x 85	70 x 120
45°/45°	60	80	70 x 70	70 x 80

Model	MKS 315 N	MKS 315 R	MKS 316 R
Art. no.	3620303	3621315	3621316

Technical specifications	MKS 315 N	MKS 315 R	MKS 316 R
Motor output 50 Hz/400 V	1.5 - 2.2 kW	1.5 - 2.2 kW	1.32 - 1.91 kW
Speeds	40 - 80 rpm	40 - 80 rpm	20 - 40 rpm
Vice jaw width	120 mm	120 mm	120 mm
Saw blade diameter	Ø 315 mm	Ø 315 mm	Ø 315 mm
Run-in height incl. chassis	1 015 mm	1 015 mm	1 015 mm
Length	1 000 mm	1 000 mm	1 000 mm
Width	1 150 mm	1 150 mm	1 150 mm
height	1 475 mm	1 475 mm	1 475 mm
Weight	165 kg	193 kg	193 kg

Accessories	Art. no.
Machine chassis	3643171
Coolant concentrate 5 l	3601751
Spraying agent 5 l, micro-dosing unit	3608020
Micro-dosing unit assembly	9002000

Saw blades MKS 315 N/315 R/316 R

HSS saw blade DM05 Ø315x2.5x32 mm t4 ¹⁾	3653154
HSS saw blade DM05 Ø315x2.5x32 mm t6 ¹⁾	3653156
HSS saw blade DM05 Ø315x2.5x32 mm t8 ¹⁾	3653158

Saw blades for stainless steel MKS 315 R

HSS-E saw blade Ø315x2.5x32 mm t4 ¹⁾	3653254
HSS-E saw blade Ø315x2.5x32 mm t6 ¹⁾	3653256

¹⁾t = tooth spacing



Chipmag swarf remover magnetic Art. no. 3850010,

MKS 350 – manual metal-cutting circular saw with 350 mm saw blade

MKS 350 H – semi-automatic version



- ▶ Stable and robust structure
- ▶ two cutting speeds standard
- ▶ machine head swivels through 45° anti-clockwise and 90° clockwise
- ▶ Reduction gear running in oil bath
- ▶ includes diaphragm coolant pump with filter
- ▶ double vice with counter vice and burr-prevention jaws guarantees precise and burr-free cutting
- ▶ Vice longitudinally displaceable, and thus suitable for longitudinal cutting and slotting
- ▶ Quick release vice swivelling through 45° anti-clockwise and 45° clockwise

- ▶ moving guard ensures optimum safety while cutting
- ▶ Low-voltage electrical system, 24 Volt, with emergency off switch, main switch, speed selection switch and overload protection
- ▶ Control handle with safety switch
- ▶ **MKS 351 R low-speed, and thus perfect for working with stainless steel**

Semi-automatic mode MKS 350 H

- ▶ Motor is activated and
- ▶ Vice closed
- ▶ Saw head lowered for cutting
- ▶ Saw head returns to original position and motor stops
- ▶ Vice opens



- ▶ Quick release vice swivelling through 45° anti-clockwise and 45° clockwise



MKS 350 / MKS 351

MKS 350 H



Scope of delivery MKS 350 / MKS 351:

- › Coolant system
- › Cross-cut fence 500 mm
- › Operating tool
- › Without saw blade
- › Without chassis

Scope of delivery MKS 350 N:

- › Coolant system
- › Cross-cut fence 500 mm
- › Operating tool
- › Without saw blade
- › incl. chassis

Cutting capacity MKS 350 / MKS 351 / MKS 350 H

	●	○	□	▭
	60	110	100 x 100	80 x 120
	55	80	80 x 80	80 x 80

Model	MKS 350	MKS 351	MKS 350 H
Art. no.	3621350	3621351	3620352

Technical specifications			
Motor output 400 V / 50 Hz	1.8 - 2.4 kW	1.5 - 2.2 kW	1.8 - 2.4 kW
Speeds	40 - 80 rpm	20 - 40 rpm	40 - 80 rpm
Vice jaw width	120 mm		120 mm
Saw blade diameter	Ø 350 mm		Ø 350 mm
Run-in height incl. chassis	1 025 mm		1 040 mm
Length	1 000 mm		1 000 mm
Width	1 200 mm		1 200 mm
height	1 475 mm		1 475 mm
Weight	231 kg		280 kg

Accessories

	Art. no.
Machine chassis MKS 350/351	3643171
Coolant concentrate 5 l	3601751
Spraying agent 5 l, micro-dosing unit	3608020
Micro-dosing unit MD 11 - 24V AC	3608011
Micro-dosing unit MD 12 - 24V AC	3608012
Micro-dosing unit assembly	9002000

Saw blades MKS 350/351/350 H

HSS saw blade DM05Ø 350x2.5x32 mm t4 ¹⁾	3653504
HSS saw blade DM05Ø 350x2.5x32 mm t6 ¹⁾	3653506

Saw blades for stainless steel MKS 351

HSS-E saw blade Ø 350x2.5x32 mm t4 ¹⁾	3653514
HSS-E saw blade Ø 350x2.5x32 mm t6 ¹⁾	3653516

¹⁾ t = tooth spacing ²⁾ Price without installation on the saw



Chipmag swarf remover
magnetic Art. no. 3850010,

Vertical metal-cutting circular saws



MKS 315 V – manual vertical metal-cutting circular saw with 315 mm saw blade

MKS 350 V – manual vertical metal-cutting circular saw with 350 mm saw blade

MKS 316 V – low-speed version for cutting stainless steel

- ▶ Stable and robust structure
- ▶ easy and trouble-free operation
- ▶ two cutting speeds
- ▶ Vertically guided machine head, with dovetail guide and adjustable wedge bar, swivelling 45° anti-clockwise and 60° clockwise, with stops at -45°, 0°, -45°, 60°
- ▶ Adjustable depth stop for vertical stroke of saw head
- ▶ Reduction gear, runs in oil bath for low noise
- ▶ Coolant pump with coolant filter
- ▶ Coolant jet distribution for improved saw blade lubrication
- ▶ laterally displaceable vice with burr-prevention unit
- ▶ Chip breaker for cleaning the blade
- ▶ Low-voltage electrical system, 24 Volt, with emergency off switch, main switch, speed selection switch and overload protection
- ▶ Control handle with safety switch

Accessories



Chipmag swarf remover

- ▶ magnetic Art. no. 3850010,



Scope of delivery MKS 315V, 316V, 350 V:

- > Operating tool
- > Coolant system with filter
- > Material support arm with roller
- > Cross-cut fence 500 mm
- > Swarf remover T4
- > **Without saw blade**

Cutting capacity MKS 315 V, 316 V

	●	○	□	▭
0°	70	100	90 x 90	80 x 135
45°	70	100	90 x 90	80 x 100
45°	70	100	90 x 90	80 x 100
60°	70	80	70 x 70	70 x 70

Cutting capacity MKS 350 V

	●	○	□	▭
0°	100	120	100 x 100	90 x 170
45°	100	120	90 x 90	90 x 125
45°	100	120	90 x 90	90 x 125
60°	90	90	90 x 90	90 x 90

Model	MKS 315 V	MKS 316 V	MKS 350 V
Art. no.	3622315	3622316	3622350

Technical specifications	MKS 315 V	MKS 316 V	MKS 350 V
Motor output 400 V/50 Hz	1.3 - 1.8 kW	1.3 - 1.8 kW	1.9 - 2.5 kW
Speeds	33 - 66 rpm	17 - 34 rpm	36 - 72 rpm
Vice jaw width		160 mm	185 mm
Saw blade diameter	Ø 315 mm		Ø 370 mm
Run-in height incl. chassis		910 mm	905 mm
Length	1 500 mm		1 050 mm
Width	650 mm		1 000 mm
height	1 700 mm		1 850 mm
Weight		270 kg	450 kg

Accessories

Accessories	Art. no.
Coolant concentrate 5 l	3601751
Chipmag (swarf remover)	3850010
Micro-dosing unit MD 11 - 24V AC	3608011
Micro-dosing unit MD 12 - 24V AC	3608012
Micro-dosing unit assembly	9002000
Spraying agent 5 l, micro-dosing unit	3608020

Saw blades MKS 315 V/316 V

HSS saw blade DM05 Ø 315x2.5x32 mm t4 ¹⁾	3653154
HSS saw blade DM05 Ø 315x2.5x32 mm t6 ¹⁾	3653156
HSS saw blade DM05 Ø 315x2.5x32 mm t8 ¹⁾	3653158

Saw blades for stainless steel MKS 316 V

HSS-E saw blade Ø 315x2.5x32 mm t4 ¹⁾	3653254
HSS-E saw blade Ø 315x2.5x32 mm t6 ¹⁾	3653256

Saw blades MKS 350 V

HSS saw blade DM05 Ø 350x2.5x32 mm t4 ¹⁾	3653504
HSS saw blade DM05 Ø 350x2.5x32 mm t6 ¹⁾	3653506
HSS saw blade DM05 Ø 350x2.5x32 mm t8 ¹⁾	3653508
HSS saw blade DM05 Ø 350x2.5x32 mm t10 ¹⁾	3653510

¹⁾ t = tooth spacing ²⁾ Price without installation on the saw

Chip remover for MKS 315/350 V

051/24 for Ø 315, 350 mm t4	03620512404
051/24 for Ø 315, 350 mm t6	03620512406
051/24 for Ø 315, 350 mm t8	03620512408
051/24 for Ø 315, 350 mm t10	03620512410

MKS 315 VH – semi-automatic vertical metal-cutting circular saw with 315 mm saw blade. **MKS 350 VH** – semi-automatic vertical metal-cutting circular saw with 350 mm saw blade

- ▶ Stable and robust structure
- ▶ easy and trouble-free operation
- ▶ two cutting speeds
- ▶ Vertically guided machine head, with dovetail guide and adjustable wedge bar, swivelling 45° anti-clockwise and 60° clockwise, with stops at -45°, 0°, -45°, 60°
- ▶ Adjustable depth stop for vertical stroke of saw head

- ▶ Reduction gear, runs in oil bath for low noise
- ▶ Coolant pump with coolant filter
- ▶ Coolant jet distribution for improved saw blade lubrication
- ▶ laterally displaceable pneumatic quick release vice with burr-prevention unit
- ▶ Chip breaker for cleaning the blade
- ▶ Low-voltage electrical system, 24 Volt, with emergency off switch, main switch, speed selection switch, undervoltage trip and overload protection

Semi-automatic mode

- ▶ Vice closes and motor is activated
- ▶ Saw head lowered for cutting
- ▶ Motor stops and saw head returns to original position
- ▶ Vice opens



MKS 315 VH



MKS 350 VH

Scope of delivery:

- › MKS 315: Material support arm with roller
- › MKS 350: Material roller conveyor 1 000 mm
- › Cross-cut fence 500 mm
- › Operating tool
- › Swarf remover T4
- › **Without saw blade**
- › Coolant system with filter

Cutting capacity MKS 315 VH

	●	○	□	▭
0°	70	100	90 x 90	80 x 135
45°	70	100	90 x 90	80 x 100
45°	70	100	90 x 90	80 x 100
60°	70	80	70 x 70	70 x 70

Cutting capacity MKS 350 VH

	●	○	□	▭
0°	100	120	100 x 100	90 x 170
45°	100	120	90 x 90	90 x 125
45°	100	120	90 x 90	90 x 125
60°	90	90	90 x 90	90 x 90

Model	MKS 315 VH	MKS 350 VH
Art. no.	3623315	3623350
Technical specifications		
Motor output 3 x 400 V/50 Hz	1.3 - 1.8 kW	1.9 - 2.5 kW
Speeds	33 - 66 rpm	36 - 72 rpm
Clamping width machine vice	160 mm	185 mm
Saw blade diameter	Ø 315 mm	Ø 370 mm
Run-in height incl. chassis	910 mm	905 mm
Length	1 500 mm	2 640 mm
Width	650 mm	1 200 mm
height	2 000 mm	2 000 mm
Weight	300 kg	450 kg

Accessories	Art. no.
Coolant concentrate 5 l	3601751
Chipmag (swarf remover)	3850010
Micro-dosing unit MD 11 - 24V AC	3608011
Micro-dosing unit MD 12 - 24V AC	3608012
Micro-dosing unit assembly	9002000
Spraying agent 5 l, micro-dosing unit	3608020
Saw blades MKS 315 V/316 V	
HSS saw blade DM05 Ø 315x2.5x32 mm t4 ¹⁾	3653154
HSS saw blade DM05 Ø 315x2.5x32 mm t6 ¹⁾	3653156
HSS saw blade DM05 Ø 315x2.5x32 mm t8 ¹⁾	3653158
Saw blades MKS 350 V	
HSS saw blade DM05 Ø 350x2.5x32 mm t4 ¹⁾	3653504
HSS saw blade DM05 Ø 350x2.5x32 mm t6 ¹⁾	3653506
HSS saw blade DM05 Ø 350x2.5x32 mm t8 ¹⁾	3653508
HSS saw blade DM05 Ø 350x2.5x32 mm t10 ¹⁾	3653510
¹⁾ t = tooth spacing ²⁾ Price without installation on the saw	

Chip remover for MKS 315 VH/350 VH	
051/24 for Ø 315, 350 mm t4	03620512404
051/24 for Ø 315, 350 mm t6	03620512406
051/24 for Ø 315, 350 mm t8	03620512408
051/24 for Ø 315, 350 mm t10	03620512410

Vertical metal-cutting circular saws

MKS 315 VA – Automatic hydro-pneumatic vertical metal-cutting circular saw with CNC control

Arguments that impress in terms of quality, performance and price.

- ▶ Stable and robust structure
- ▶ Easy and intuitive use
- ▶ Two cutting speeds
- ▶ Vertically guided machine head, with dovetail guide and adjustable wedge bar, swivelling 45° anti-clockwise and 60° clockwise, with stops at 45°, 0°, -45°, -60°
- ▶ Adjustable depth stop for vertical stroke of saw head
- ▶ Reduction gear, runs in oil bath for low noise
- ▶ Coolant pump with coolant filter
- ▶ Coolant jet distribution for improved saw blade lubrication

- ▶ Laterally displaceable pneumatic quick release vice with burr-prevention unit
- ▶ Chip breaker T6 for cleaning the blade
- ▶ Low-voltage electrical system, 24 Volt, with emergency off switch, main switch, speed selection switch, undervoltage trip and overload protection
- ▶ the control unit has 49 programs, each with up to 99 individual steps

Automatic mode

- ▶ Material feed
- ▶ Vice closes and motor is activated
- ▶ Coolant pump activated
- ▶ Saw head lowered for cutting
- ▶ Feed carriage returns to the defined dimension
- ▶ Saw head returns to original position
- ▶ Vice opens
- ▶ Cycle repeats



MKS 315 VA

Scope of delivery:

- > Machine chassis
- > Coolant system with filter
- > Material roller conveyor 1 000 mm
- > Operating tool
- > Instructions for use
- > Swarf remover T4
- > Without saw blade

Cutting capacity MKS 315 VA

	●	○	□	▭
0°	70	100	90 x 90	80 x 120
45°	70	90	80 x 80	80 x 80
45°	70	90	80 x 80	80 x 80
60°	70	80	70 x 70	80 x 70

Model	MKS 315 VA
Art. no.	3624315

Technical specifications	
Motor output 3 x 400 V/50 Hz	1.3 - 1.8 kW
Speeds	33 - 66 rpm
Feed	600 mm
Clamping width machine vice	120 mm
Saw blade diameter	Ø 315 mm
Dimensions (L x W x H)	2 500 x 1 000 x 2 000 mm
Weight	550 kg

Accessories

	Art. no.
Coolant concentrate 5 l	3601751
Chipmag (swarf remover)	3850010
Micro-dosing unit MD 11 - 24V AC	3608011
Micro-dosing unit MD 12 - 24V AC	3608012
Micro-dosing unit assembly	9002000

Saw blades MKS 315 VA

HSS saw blade DM05 Ø 315x2.5x32 mm t ₄ ¹⁾	3653154
HSS saw blade DM05 Ø 315x2.5x32 mm t ₆ ¹⁾	3653156
HSS saw blade DM05 Ø 315x2.5x32 mm t ₈ ¹⁾	3653158

¹⁾ t = tooth spacing

Chip remover for MKS 315 VA

051/24 for Ø 315, 350 mm t ₄	03620512404
051/24 for Ø 315, 350 mm t ₆	03620512406
051/24 for Ø 315, 350 mm t ₈	03620512408
051/24 for Ø 315, 350 mm t ₁₀	03620512410

MKS 350 VA – Automatic hydraulic vertical metal-cutting circular saw with CNC control

Arguments that impress in terms of quality, performance and price.

- ▶ Stable and robust structure
- ▶ easy and intuitive use
- ▶ the control unit has 49 programs, each with up to 99 individual steps
- ▶ two cutting speeds
- ▶ Vertically guided machine head, with dovetail guide and adjustable wedge bar, swivelling 45° anti-clockwise and 45° clockwise, with stops at 45°, 0°, -45°
- ▶ Adjustable depth stop for vertical stroke of saw head

- ▶ Reduction gear, runs in oil bath for low noise
- ▶ Coolant pump with coolant filter
- ▶ Coolant jet distribution for improved saw blade lubrication
- ▶ laterally displaceable hydraulic quick release vice with burr-prevention unit
- ▶ Chip breaker T6 for cleaning the blade
- ▶ Low-voltage electrical system, 24 Volt, with emergency off switch, main switch, speed selection switch, undervoltage trip and overload protection

Automatic mode

- ▶ Material feed
- ▶ Vice closes and motor is activated
- ▶ Activation of coolant pump; saw head lowered for cutting
- ▶ Feed carriage returns to the defined dimension
- ▶ Saw head returns to original position
- ▶ Vice opens
- ▶ Cycle repeats





MKS 350 VA

Scope of delivery:

- › Machine chassis
- › Coolant system with filter
- › Material roller conveyor 1 000 mm
- › Instructions for use
- › Swarf remover T4
- › Without saw blade

Cutting capacity MKS 350 VA

	●	○	□	▭
	100	130	120 x 120	100 x 170
	100	130	110 x 110	100 x 140

Model	MKS 350 VA
Art. no.	3624350

Technical specifications	
Motor output 3 x 400 V/50 Hz	1.9 - 2.5 kW
Speeds	25/50 rpm
Feed	600 mm
Clamping width machine vice	185 mm
Saw blade diameter	Ø 370 mm
Dimensions (L x W x H)	3 500 x 1 200 x 1 900 mm
Weight	900 kg

Accessories	Art. no.
Coolant concentrate 5 l	3601751
Chipmag (swarf remover)	3850010
Micro-dosing unit MD 11 - 24V AC	3608011
Micro-dosing unit MD 12 - 24V AC	3608012
Micro-dosing unit assembly	9002000

Saw blades MKS 315 VA

HSS saw blade DM05 Ø 350x2.5x32 mm t4 ¹⁾	3653504
HSS saw blade DM05 Ø 350x2.5x32 mm t6 ¹⁾	3653506
HSS saw blade DM05 Ø 350x2.5x32 mm t8 ¹⁾	3653508
HSS saw blade DM05 Ø 350x2.5x32 mm t10 ¹⁾	3653510

¹⁾ t = tooth spacing

Chip remover for MKS 350 VA

051/24 for Ø 315, 350 mm t4	03620512404
051/24 for Ø 315, 350 mm t6	03620512406
051/24 for Ø 315, 350 mm t8	03620512408
051/24 for Ø 315, 350 mm t10	03620512410

Vertical metal-cutting circular saws/light alloy metal-cutting circular saws

LMS 400 / LMS 400 H / LMS 400 P – manual and semi-automatic light alloy metal-cutting circular saws with 400 mm saw blade



- ▶ Circular sawing machines for cutting full material and profiles made of aluminium and light alloys
- ▶ Stable and robust structure
- ▶ Easy and trouble-free operation
- ▶ Precise cutting
- ▶ Saw head swivels through 45° anti-clockwise and 45° clockwise
- ▶ Saw head tilts 45° anti-clockwise for compound cut
- ▶ Rotary plate with bearings
- ▶ Sawing shaft with bearings

LMS 400

- ▶ Manual version
- ▶ Two manual vices with plastic covered aluminium jaws
- ▶ Saw head swivels 45° anti-clockwise for compound cut

LMS 400 H

- ▶ Semi-automatic version
- ▶ Two pneumatic quick release vices with plastic covered aluminium jaws

LMS 400 P

- ▶ Saw head swivels 45° anti-clockwise for compound cut
- ▶ Two pneumatic vices with plastic covered aluminium jaws
- ▶ Control handle with safety switch



LMS 400

Scope of supply LMS 400:

- › Cross-cut fence 500 mm
- › Operating tool
- › **Without chassis**
- › **Without saw blade**



LMS 400 H

Scope of supply LMS 400 H:

- › Material support arm with roller
- › Cross-cut fence 500 mm
- › Operating tool
- › **With chassis**
- › **Without saw blade**



LMS 400 P

Scope of supply LMS 400 P:

- › Two pneumatic quick release vices
- › Cross-cut fence 500 mm
- › Operating tool
- › **Without chassis**
- › **Without saw blade**

Model	LMS 400	LMS 400 H	LMS 400 P
Art. no.	3625400	3625401	3625402

Technical specifications			
Motor output 3 x 400 V/50 Hz	2.2 kW	2.2 kW	2.2 kW
Speeds	3 000 rpm	3 000 rpm	3 000 rpm
Clamping width machine vice	180 mm	180 mm	180 mm
Saw blade diameter	Ø 400 mm	Ø 400 mm	Ø 400 mm
Run-in height incl. chassis	855 mm	855 mm	855 mm
Dimensions (L x W x H) in mm	1 500 x 1 000 x 900	1 500 x 1 000 x 1 600	1 500 x 1 000 x 1 600
Weight	160 kg	210 kg	210 kg

Cutting capacity LMS 400 / LMS 400 H / LMS 400 P

	●	○	□	▭
0°	60	140	110 x 110	100 x 180
45°/45°	60	130	100 x 100	100 x 150

Micro-dosing unit standard equipment

Universally deployable for minimal lubrication of tool blades and forming tools.

Separate air and spraying agent lines avoid dripping

- ▶ With extra large lubricant tank, frequency-controlled pump and spray head

Micro-dosing unit MD 11

- ▶ For circular saws and metal-cutting band saws



MD 11

Micro-dosing unit MD 12, special features

- ▶ Filter pressure regulator with water separator
- ▶ Robust sheet steel housing
- ▶ Coaxial hose with flexible steel jacket



MD 12

Accessories

Accessories	Art. no.
Machine chassis LMS 400	3644071
Coolant concentrate 5 l	3601751
Chipmag (swarf remover)	3850010
Micro-dosing unit MD 11 - 24V AC	3608011
Micro-dosing unit MD 12 - 24V AC	3608012
Micro-dosing unit assembly	9002000
Saw blades MKS 315 VA	
HM saw blade Ø 400 x 4.0 x 32 mm T96	3654048

LMS 400 A – automatic light alloy metal-cutting saw with 400 mm saw blade

- ▶ automatic circular sawing machine for cutting full material and profiles made of aluminium and light alloys
- ▶ Stable and robust structure
- ▶ easy and intuitive use
- ▶ precise cutting
- ▶ rotary plate with bearings
- ▶ three pneumatic quick release vices with Teflon jaws
- ▶ Automatic mode
- ▶ Material feed
- ▶ Vice closes and motor is activated
- ▶ Coolant pump activated
- ▶ Saw head is lowered until the cut is complete
- ▶ Feed carriage returns to the defined dimension
- ▶ Saw head returns to original position
- ▶ Vice opens
- ▶ Cycle repeats



Scope of delivery:

- › Material roller conveyor 1 000 mm
- › Cross-cut fence 500 mm
- › Operating tool

Model	LMS 400 A
Art. no.	3625404

Technical specifications	
Motor output 3 x 400 V/50 Hz	2.2 kW
Speeds	3 000 rpm
Clamping width machine vice	180 mm
Saw blade diameter	Ø 400 mm
Feed length	900 mm
Run-in height incl. chassis	910 mm
Dimensions (L x W x H)	3 800 x 1 600 x 1 700 mm
Weight	510 kg

Cutting capacity LMS 400 A

	●	○	□	▭
60	140	110 x 110	100 x 180	

Accessories	Art. no.
Coolant concentrate 5 l	3601751
Chipmag (swarf remover)	3850010
Micro-dosing unit MD 11 - 24V AC	3608011
Micro-dosing unit MD 12 - 24V AC	3608012
Micro-dosing unit assembly	9002000
Saw blades MKS 315 VA	
HM saw blade Ø 400 x 4.0 x 32 mm T96	3654048

¹⁾ Price without installation on the saw



Underground light metal cutting circular saw

New

ULMS – Automatic light alloy metal-cutting saw with upright blade \varnothing 420/500 mm

- ▶ For cutting aluminium and plastic profiles
- ▶ Safe cutting thanks to cover equipped with safety sensor
- ▶ Cutting at mitre angles between -45° and $+45^\circ$
- ▶ Continuously adjustable saw blade feed
- ▶ Pneumatic vertical and horizontal clamping
- ▶ Integrated minimum quantity lubrication



Fig. shows **ULMS 420** with accessories roller conveyor with cross-cut fence and manual measuring system with mm scale

Scope of supply ULMS 420
2x saw blade 420 x 30 x 4 mm T96
Cooling system

Scope of supply ULMS 500
2x saw blade 500 x 30 x 4 mm T120
Cooling system

Cutting capacity ULMS 420

	135 x 135
	125 x 125

Cutting capacity ULMS 500

	170 x 170
	160 x 160

Model	ULMS 420	ULMS 500
Art. no.	3627420	3627500
Technical specifications		
Saw band speed	3 580 rpm	3 580 rpm
Saw blade diameter	420 mm	500 mm
Cutting angle	$-90^\circ, -67,5^\circ, -45^\circ, -30^\circ, -22,5^\circ, -15^\circ, 0^\circ, 15^\circ, 22,5^\circ, 30^\circ, 45^\circ$	$-90^\circ, -67,5^\circ, -45^\circ, -30^\circ, -22,5^\circ, -15^\circ, 0^\circ, 15^\circ, 22,5^\circ, 30^\circ, 45^\circ$
Speeds	3 000 rpm	3 000 rpm
Motor output	3 kW / 400 V	3 kW / 400 V
Dimensions (L x W x H)	795 x 1 080 x 1 325 mm	855 x 1 135 x 1 360 mm
Weight	213 kg	229 kg

For the matching pure air deduster **RLA 1213 M** see our **HOLZKRAFT** catalogue 2019





Simple and clear-cut operation

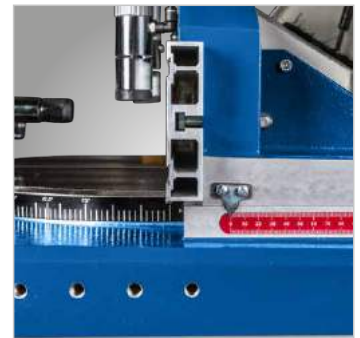

Stop continuously adjustable

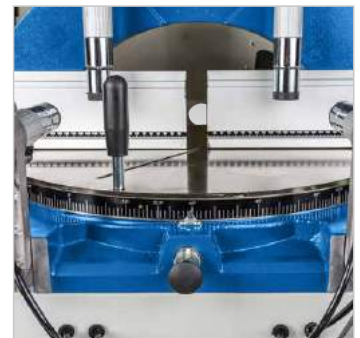

Continuous adjustment of the mitre angle

Accessories

	Art. no.
3 m roller conveyor with cross-cut fence and manual measuring system with mm scale.	3628003
Attachment side: right	
3 m roller conveyor with cross-cut fence and manual measuring system with mm scale.	3628004
Attachment side: left	
6 m roller conveyor with cross-cut fence and manual measuring system with mm scale.	3628006
Attachment side: right	
6 m roller conveyor with cross-cut fence and manual measuring system with mm scale.	3628007
Attachment side: left	
Saw blade 420 x 30 x 4 mm T96	3628042
Saw blade 500 x 30 x 4 mm T120	3628050

New

HOLZKRAFT minimax si 400es ALU 2 – professional, heavy-duty sliding table saws and format sliding sizing carriages made of anodised aluminium, specially designed for cutting aluminium and plastics

- ▶ Easy action, anodised aluminium sliding sizing carriage
- ▶ Table boom telescopic arm (longitudinally displaceable) with material roller and large surface area
- ▶ Extensible, telescopic cross-cut fence with two folding stops
- ▶ Precision rip fence, fold-away for large boards, with quick clamping and integrated granular adjustment
- ▶ With table width and length extension and eccentric clamp as standard
- ▶ **Robust, annular cast iron sawing unit – with double pivot segment guide (double cradle) and zero point pivoting for a smooth and perfect cut**
- ▶ Large torsion-free, grey cast work table
- ▶ On/off switch on sliding carriage
- ▶ Heavy deadweight ensures precision and smooth action
- ▶ Two cutting speeds switchable via inverter
- ▶ Stop below table can be swivelled away
- ▶ Cutting width 1270 mm



Scope of delivery minimax si400es 26 ALU 2:

Anodised aluminium sliding sizing carriage
Material roll on boom
Saw rip fence with rod guide
Table extension
Table width extension
Folding stops
Clamp sleigh
Eccentric clamp
Handle for sliding carriage
Saw blade swing protection
Micro-spraying device
2 saw blade speeds,
Electronically adjustable via inverter

Model	minimax si 400es 26 ALU 2
Art. no.	5504790

Technical specifications	
Table dimensions	940 x 560 mm
Table height	900 mm
Trimming length	3 200 mm
Dimensions sliding sizing carriage	360 x 142 x 3 200 mm
Max. cutting height 90°/45°	138 / 98 mm
Max. cross-cutting width left of saw blade	3 260 mm
Cutting width with rip fence	1270 mm
Saw blade angle	90° - 45°
Max. saw blade Ø	Ø 400 mm
Main saw blade speed	3 500/5 000 rpm
Motor output 400 V / 50 Hz / S6 - 40%	7.0 kW
Extraction port diameter	120 mm
Extraction duct Ø Saw blade protection	80 mm
Weight	715 kg
Transport width	990 mm



For the matching pure air deduster RLA 1601 P & RLA 2001 P see our HOLZKRAFT catalogue 2019

Info & video



Micro-dosing unit

- ▶ With extra large lubricant tank, frequency-controlled pump and spray head
- ▶ Separate air and spraying agent lines avoid dripping

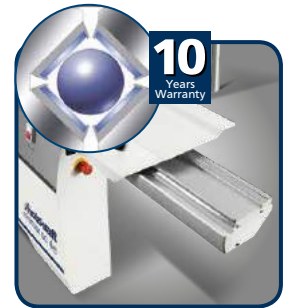

Aluminium sliding carriage

- ▶ Sliding carriage is guided in highly-precise way and easily thanks to ball contact system proven in thousands of applications
- ▶ Ten years' HOLZKRAFT warranty on wear of the tempered guide rails

Sliding carriage
360 mm

6 YEARS' HOLZKRAFT WARRANTY on wear of the swivelling segments



Tilt segment

- ▶ Permanent precision through 2x tilt segment guide



- ▶ With manual height adjustment and saw unit swivelling via hand-wheel
- ▶ Two cutting speeds switchable via inverter
- ▶ Switching-on of micro-spraying unit at side possible

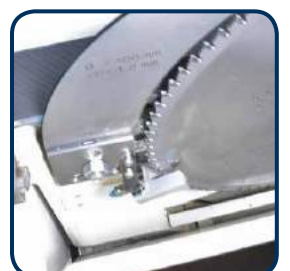

- ▶ Micro-dosing unit directly on saw blade

For cutting aluminium!



Accessories	Saw blade 400 mm
Art. no.	3650400
Saw blade Ø	400 mm
Saw blade hole	4.0 mm
Cutting width	30 mm
Saw blade teeth	72
Tooth shape	Triple-chip flat tooth
Quality	HM

**Cannot be retrofitted, only for new machine orders

Magnetic drilling
Deburring
Metal grinding
Cutting
Notching & punching
Bending
Presses
Circular saws
Roller conveyors
Metal-cutting band saws

Saw blades

Saw blades for all Metallkraft circular saws

HKS 230		Art. no.	Saw blades for stainless steel MKS 351		Art. no.
Saw blade for steel	Ø 230 x 2.0 x 25.4 mm	3850231	HSS -E saw blade	Ø 350 x 2.5 x 32 mm t4	3653514
Saw blade for aluminium	Ø 230 x 2.4 x 25.4 mm	3850232	HSS -E saw blade	Ø 350 x 2.5 x 32 mm t6	3653516
Saw blade for stainless steel	Ø 230 x 1.8 x 25.4 mm	3850233	MKS 315 V, MKS 316 V		
MTS 356			HSS saw blade DM05	Ø 315 x 2.5 x 32 mm t4	3653154
Saw blade for steel	Ø 355 x 2.4 x 25.4 mm t80	3853504	HSS saw blade DM05	Ø 315 x 2.5 x 32 mm t6	3653156
Saw blade for aluminium	Ø 355 x 2.4 x 25.4 mm t80	3853502	HSS saw blade DM05	Ø 315 x 2.5 x 32 mm t8	3653158
Saw blade for stainless steel	Ø 355 x 2.4 x 25.4 mm t90	3853503	Saw blades for stainless steel MKS 316 V		
Saw blade for steel	Ø 305 x 2.4 x 25.4 mm t60	3853051	HSS -E saw blade	Ø 315 x 2.5 x 32 mm t4	3653254
MKS 250 N, MKS 255 N			HSS -E saw blade	Ø 315 x 2.5 x 32 mm t6	3653256
HSS saw blade DM05	Ø 250 x 2 x 32 mm t4	3652504	MKS 350 V		
HSS saw blade DM05	Ø 250 x 2 x 32 mm t6	3652506	HSS saw blade DM05	Ø 350 x 2.5 x 32 mm t4	3653504
MKS 275 N			HSS saw blade DM05	Ø 350 x 2.5 x 32 mm t6	3653506
HSS saw blade DM05	Ø 275 x 2.5 x 32 mm t4	3652754	HSS saw blade DM05	Ø 350 x 2.5 x 32 mm t8	3653508
HSS saw blade DM05	Ø 275 x 2.5 x 32 mm t6	3652756	HSS saw blade DM05	Ø 350 x 2.5 x 32 mm t10	3653510
HSS saw blade DM05	Ø 275 x 2.5 x 32 mm t8	3652758	MKS 315 VH		
MKS 315 N, MKS 315 R, MKS 316 R			HSS saw blade DM05	Ø 315 x 2.5 x 32 mm t4	3653154
HSS saw blade DM05	Ø 315 x 2.5 x 32 mm t4	3653154	HSS saw blade DM05	Ø 315 x 2.5 x 32 mm t6	3653156
HSS saw blade DM05	Ø 315 x 2.5 x 32 mm t6	3653156	HSS saw blade DM05	Ø 315 x 2.5 x 32 mm t8	3653158
HSS saw blade DM05	Ø 315 x 2.5 x 32 mm t8	3653158	MKS 350 VH		
Saw blades for stainless steel MKS 315 R			HSS saw blade DM05	Ø 350 x 2.5 x 32 mm t4	3653504
HSS -E saw blade	Ø 315 x 2.5 x 32 mm t4	3653254	HSS saw blade DM05	Ø 350 x 2.5 x 32 mm t6	3653506
HSS -E saw blade	Ø 315 x 2.5 x 32 mm t6	3653256	HSS saw blade DM05	Ø 350 x 2.5 x 32 mm t8	3653508
MKS 350, MKS 351, MKS 350 H			HSS saw blade DM05	Ø 350 x 2.5 x 32 mm t10	3653510
HSS saw blade DM05	Ø 350 x 2.5 x 32 mm t4	3653504	LMS 400, LMS 400 H, LMS 400 A		
HSS saw blade DM05	Ø 350 x 2.5 x 32 mm t6	3653506	HM saw blade	Ø 400 x 4.0 x 32 mm t96	3654048

Teeth per inch (t)

When selecting a suitable saw blade for cutting a material, it is important to pay attention to the correct number of teeth per inch, which is a prerequisite for good cutting results. A rule of thumb states that the lowest teeth per inch figure should be selected that still allows for good swarf discharge from the cutting zone. This rule does not help you find the right tpi, but it does explain the logic of the right choice.

The following parameters must be known for the selection: 1. Cross section of the material, 2. Material type, 3. Application or cutting method

Cutting speed and feed

Choosing the right saw blade speed and feed rate is decisive to optimising the cutting process. There is a close relationship between the two speeds. For example, if the saw blade speed is too high compared to the saw's feed speed, the workpiece will be polished rather than cut. The saw blade will overheat and wear without providing cutting performance.

The following table contains recommendations for the correct use of our metal-cutting circular saw blades; of course, the values are only approximate guidelines:

	Steels up to 1 500 N/m ²	Steels up to 1 800 N/m ²	Steels up to 1 200 N/m ²	Stainless steels	Cast iron	Aluminium	Bronze/copper	Brass
Pipes/sections wall thickness								
Teeth per inch t (mm)								
up to 1 mm	3	3	3	3	-	4	4	4
1 - 1.5 mm	4	4	3	4	-	5	5	5
1.5 - 2 mm	5	4	4	5	-	6	6	6
2 - 3 mm	5	5	5	5	-	7	7	7
from 3 mm	6	6	5	6	-	8	8	8
Full materials cross cutting								
Teeth per inch t (mm)								
10-20 mm	5	5	5	5	5	6	6	8
20-40 mm	8	6	6	6	6	8	8	10
40-60 mm	10	10	8	8	8	12	10	12
60-90 mm	12	12	10	11	11	16	13	14
90-110 mm	14	14	12	14	14	18	15	17
110-130 mm	16	16	14	16	16	20	17	19
130-150 mm	18	16	14	16	16	20	19	20
Teeth per inch t (mm)								
Feed A (mm/min) for full materials pipes/sections								
3	350-450	250-350	90-160	70-150	350-550	-	-	-
4	300-400	200-300	80-140	60-130	280-440	-	-	-
5	250-350	150-250	70-130	55-110	210-350	-	-	-
6	200-300	100-180	60-120	50-90	180-300	-	1 400-2 000	2 000-4 000
8	150-250	80-130	35-90	40-75	140-250	4 500-8 500	1 000-1 600	1 500-3 200
10	100-200	70-100	40-80	35-65	120-180	3 800-6000	700-1 200	1 000-2 500
12	80-150	65-90	35-65	30-55	90-150	3 000-5 000	550-850	800-1 800
14	70-130	60-80	25-50	20-50	75-125	2 800-4 600	500-700	700-1 400
16	50-120	55-70	15-40	15-35	65-110	2 500-3 700	400-600	600-1 000
Saw blade Ø								
rpm								
250 mm	40-65	25-50	20-30	15-25	40-65	750-1100	250-380	500-700
300 mm	30-55	20-45	15-25	10-20	30-55	650-950	210-320	430-640
315 mm	30-50	20-40	15-25	10-20	30-50	600-900	200-300	400-600
350 mm	25-45	20-35	15-25	10-20	25-45	550-820	180-270	350-550
400 mm	20-40	15-30	10-20	8-15	20-40	470-720	160-240	300-480



Roller conveyors

Universal chassis/Material stands/Roller and measuring conveyors

Unicraft UF 300 – Universal chassis with 300 kg load-bearing capacity

New



- ▶ Chassis with variably adjustable load platform
- ▶ For easy transport and relocation of machines
- ▶ Grid supports many different load platform size settings
- ▶ Easy to manoeuvre thanks to two steering rollers which rotate through 360°
- ▶ Safe and stable design
- ▶ Fast and easy assembly

Model	UF 300
Art. no.	6190300

Technical specifications	
Load-bearing capacity	300 kg
Square load platform min.	345 x 345 mm
Square load platform max.	730 x 730 mm
Hole spacing	25.4 mm
Weight	9 kg



Material stand MS 3 – continuously height-adjustable, loadable up to 700 kg

- ▶ for supporting long and heavy workpieces
- ▶ universally deployable for, e.g., metal-cutting circular saws, metal-cutting band saws, woodworking machines, etc.
- ▶ Roller support, continuously adjustable and clampable
- ▶ Safe workpiece support due to solid steel rollers with high load-bearing capacity
- ▶ heavy three-leg cast iron version for highest loads

Model	MS 3	MS 3 V
Art. no.	3660700	3660705

Technical specifications		
Load-bearing capacity	700 kg	700 kg
Roller width	400 mm	2 x 130 mm
Min./max. height	580/970 mm	580/970 mm
Ausführung	Steel rollers	Steel rollers
Roller diameter	52 mm	52 mm



Material stand MS 4 – continuously adjustable

- ▶ different roller types available
- ▶ Roller support, continuously adjustable
- ▶ extra wide support
- ▶ Universal use



MS 4 K

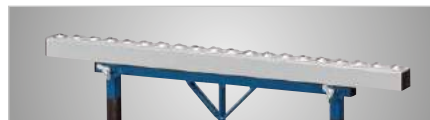

MS 4 R

Model	MS 4	MS 4 R	MS 4 K
Art. no.	3660110	3660111	3660112

Technical specifications			
Load-bearing capacity	500 kg	500 kg	500 kg
Length	700 mm	980 mm	1 000 mm
Min./max. height	760 / 1 030 mm	700 / 960 mm	700 / 960 mm
Variant	Plastic roller	Multi-directional roller track	Ball transfer track
Roller diameter	90 mm	-	-



MRB LC – the roller and measuring track system with a lightweight design and a load-bearing capacity of 100 kg pro metre of roller conveyor

- ▶ Roller and measuring track system for precise sawing, drilling or milling of lighter wood metal and plastic sections
- ▶ Sub-structure made of solid 3 mm steel sections, painted and with adjustable feet
- ▶ Idler rollers made of galvanised steel (optionally also available with plastic idler rollers)

Especially for MRB LC-B and MRB LC-E

- ▶ The stop carriage is 4x roller borne, and thus easy to move manually
- ▶ Stop arm is adjustable and can be tilted to the rear
- ▶ The maximum measuring length is the track length minus the stop length

MRB LC-B: 250 mm
MRB LC-E: 250 mm



Quality Made in Germany

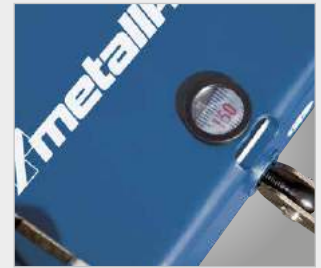

- ▶ MRB LC-B: supplied with magnifying glass as standard for easier reading off of the millimetre scale



770 - 1 070 mm

MRB LC-C
Standard type

MRB LC-B
with scale fig. shows 3 m version

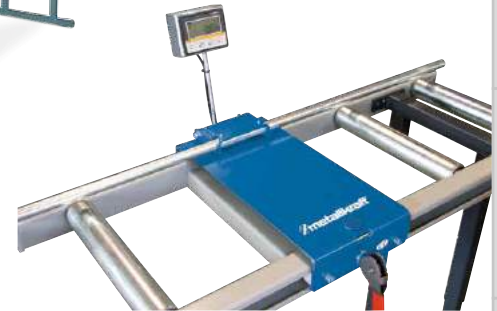

MRB LC-E
with magnetic strip, length measuring device with digital display and 4x roller borne stop carriage

Technical data MRB LC series

Roller diameter	50 mm
Shaft diameter	8 mm
usable roller width	300 mm
load-bearing capacity per metre	100 kg/m
Working height	770 - 1 070 mm

Optional

Additional supporting leg for MRB LC-C, LC-B and LC-E Art. no. 3663000

Plastic rollers (surcharge per metre) Art. no.
for LC roller conveyors 3669990

MRB LC-C

Feed roller conveyor without cross-cut fence and without measuring system

Length	Roller conveyor feet	Art. no.
2 m	2	3662320
3 m	3	3662330
4 m	3	3662340
5 m	4	3662350
6 m	5	3662360

MRB LC-B

Stop track with cross-cut fence, manual measuring system with mm scale and magnifying glass for reading off, stop adjustable and can be tilted to the rear

Length	Roller conveyor feet	Art. no.
2 m	2	3662220
3 m	3	3662230
4 m	3	3662240
5 m	4	3662250
6 m	5	3662260

MRB LC-E

Roller conveyor with cross-cut fence, magnetic tape measuring system with digital display, otherwise as per MRB LC-B

Length	Roller conveyor feet	Art. no.
2 m	2	3662420
3 m	3	3662430
4 m	3	3662440
5 m	4	3662450
6 m	5	3662460

Assembly adapter

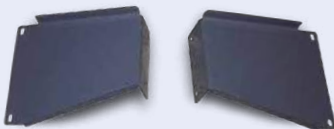

for stable fastening of MRB LC series roller conveyors to Metalkraft metal-cutting circular saws The adapters are specially designed for installation on the right or left of the saws

Assembly adapter

Saw type	Assembly position	Art. no.
MKS250N	right	3672201
MKS250N	left	3672101
MKS315N	right	3672202
MKS315N	left	3672102
MKS315V	right	3672204
MKS315V	left	3672104

Saw type	Assembly position	Art. no.
MKS350V	right	3672205
MKS350V	left	3672105
LMS400	right	3672203
LMS400	left	3672103
LMS 400 PRO	right	3672206
LMS 400 PRO	left	3672106

MRB standard – the roller and measuring track system with a robust design and a load-bearing capacity of 300 kg pro metre of roller conveyor

- ▶ sturdy U-shaped, closed design made from 3 mm sheet metal sections.
- ▶ Idler rollers made of galvanised steel
- ▶ all roller conveyors in the MRB Standard series are also available with plastic idler rollers (see plastic rollers at the bottom of the next page)
- ▶ Ball-bearing borne idler rollers

The maximum measuring length is the track length minus the stop length:

- MRB Standard A:** 450 mm
- MRB Standard BKF, EKF:** 400 mm
- MRB Standard B:** 260 mm

Technical specifications	
Roller diameter	60 mm
Shaft diameter	15 mm
Usable roller width	250/350 mm
load-bearing capacity per metre	300 kg/m
Height-adjustable feet	+/- 60 mm
Working height	880 mm

MRB Standard C

- ▶ Feed/discharge roller conveyors
- ▶ Roller conveyors without a scale and stop with lateral guides



MRB Standard C

MRB Standard B

- ▶ With with length measuring unit
- ▶ Roller and measuring track with mm scale, manual measuring system with C guide profile and adjustable folding stop



MRB Standard B

MRB Standard BKF

- ▶ Precision flat steel guide attached to rear of roller conveyor
- ▶ sturdy, 6x ball bearing borne material stop carriage, easy action, manually adjustable and clampable
- ▶ Stop carriage with magnifying glass facilitates reading off the mm scale
- ▶ robust stop arm mounted on stop carriage; adjustable up to tool (0 point)

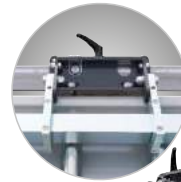

MRB Standard BKF

MRB Standard C - track width 300 mm (usable roller width 250 mm)

Length	Roller track feet	Art. no.
1 m	2	3661311
2 m	2	3661312
3 m	3	3661313
4 m	3	3661314
5 m	4	3661315
6 m	5	3661316
7 m	5	3661317
8 m	6	3661318

MRB Standard B - track width 300 mm (usable roller width 250 mm)

Length	Roller track feet	Art. no.
1 m	2	3661211
2 m	2	3661212
3 m	3	3661213
4 m	3	3661214
5 m	4	3661215
6 m	5	3661216
7 m	5	3661217
8 m	6	3661218

MRB Standard BKF - track width 300 mm (usable roller width 250 mm)

Length	Roller track feet	Art. no.
1 m	2	3661231
2 m	2	3661232
3 m	3	3661233
4 m	3	3661234
5 m	4	3661235
6 m	5	3661236
7 m	5	3661237
8 m	6	3661238

MRB Standard C - track width 400 mm (usable roller width 350 mm)

Length	Roller track feet	Art. no.
1 m	2	3661321
2 m	2	3661322
3 m	3	3661323
4 m	3	3661324
5 m	4	3661325
6 m	5	3661326
7 m	5	3661327
8 m	6	3661328

MRB Standard B - track width 400 mm (usable roller width 350 mm)

Length	Roller track feet	Art. no.
1 m	2	3661221
2 m	2	3661222
3 m	3	3661223
4 m	3	3661224
5 m	4	3661225
6 m	5	3661226
7 m	5	3661227
8 m	6	3661228

MRB Standard BKF - track width 400 mm (usable roller width 350 mm)

Length	Roller track feet	Art. no.
1 m	2	3661241
2 m	2	3661242
3 m	3	3661243
4 m	3	3661244
5 m	4	3661245
6 m	5	3661246
7 m	5	3661247
8 m	6	3661248

Assembly adapters on Metalkraft metal-cutting circular saws

The adapters are specially designed for installation on the right or left of the saws for the MRB Standard series on Metalkraft metal-cutting circular saws **Please state your sawing machine type with your order.**

For assembly of the MRB Standard models (300 mm):

For assembly of the MRB Standard models (400 mm):

Saw type	Assembly pos.	Art. no.	Saw type	Assembly pos.	Art. no.
MKS250N	right	3671211	MKS250N	right	3671221
MKS250N	left	3671111	MKS250N	left	3671121
MKS315N	right	3671212	MKS315N	right	3671222
MKS315N	left	3671112	MKS315N	left	3671122
MKS315V	right	3671214	MKS315V	right	3671224
MKS315V	left	3671114	MKS315V	left	3671124
MKS350V	right	3671215	MKS350V	right	3671225
MKS350V	left	3671115	MKS350V	left	3671125
LMS400	right	3671213	LMS400	right	3671223
LMS400	left	3671113	LMS400	left	3671123

Please state the installation side and system height with your order!
Working height up to 1 020 mm possible with optional foot plate.

On request:

- ▶ Working height as of 1 020 mm extensible as a factory option
- ▶ also with 500 mm track width

MRB Standard EKF

- ▶ As per MRB Standard BKF
- ▶ With with length measuring unit and digital dimension display system
- ▶ Roller and measuring track with battery operated LCD display and magnetic strip measuring system

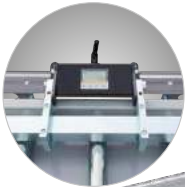

MRB Standard A

- ▶ Length measuring unit with handwheel adjustment
- ▶ Roller and measuring track with LED dimension display (mm), incl. mains adapter 230 V
- ▶ Measuring stop adjustable via handwheel from workplace, with pneumatic brake for dimensional fixing
- ▶ robust material stop carriage, 12x ball-bearing borne, movable on generously dimensioned guide profile; the stop arm is adjustable and can be folded back
- ▶ a cable drag chain is required for roller conveyors with a length of more than 5 m
- ▶ Installation side right or left, in line with customer's needs

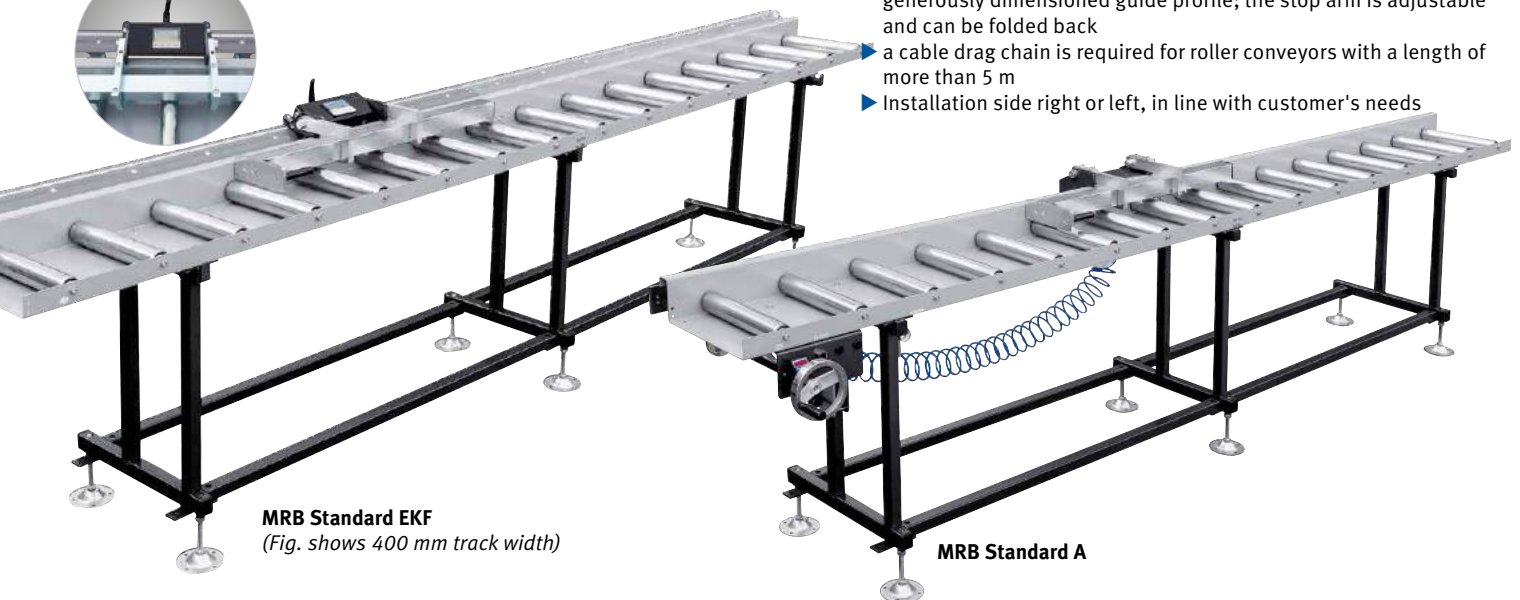

MRB Standard EKF
(Fig. shows 400 mm track width)

MRB Standard A

MRB Standard EKF - track width 300 mm (usable roller width 250 mm)

Length	Roller track feet	Art. no.
1 m	2	3661711
2 m	2	3661712
3 m	3	3661713
4 m	3	3661714
5 m	4	3661715
6 m	5	3661716
7 m	5	3661717
8 m	6	3661718

MRB Standard A - track width 300 mm (usable roller width 250 mm)

Length	Roller track feet	Art. no.
2 m	2	3661112
3 m	3	3661113
4 m	3	3661114
5 m	4	3661115
6 m	5	3661116
7 m	5	3661117
8 m	6	3661118

MRB Standard EKF - track width 400 mm (usable roller width 350 mm)

Length	Roller track feet	Art. no.
1 m	2	3661721
2 m	2	3661722
3 m	3	3661723
4 m	3	3661724
5 m	4	3661725
6 m	5	3661726
7 m	5	3661727
8 m	6	3661728

MRB Standard A - track width 400 mm (usable roller width 350 mm)

Length	Roller track feet	Art. no.
2 m	2	3661122
3 m	3	3661123
4 m	3	3661124
5 m	4	3661125
6 m	5	3661126
7 m	5	3661127
8 m	6	3661128

- ▶ 5-digit LED dimension display for continuous checking of the current stop carriage state with millimetre accuracy
- ▶ Position display with hollow shaft rotary encoder mounted directly on the drive shaft
- ▶ Measuring precision: 2/10 mm



- ▶ 900 mm stop arm length
- ▶ Guide plate adjustable to zero point; can be folded to the rear manually
- ▶ Multiply ball bearing-borne and thus free from play

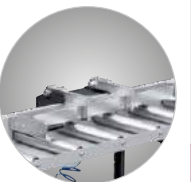

Option foot plate with spindle M 16 x 250 mm
For height adjustment up to 1 020 mm
Art. no. 3679000

Plastic rollers (surcharge per metre)	Art. no.
for MRB standard roller conveyor with track width 300 mm	3669991
for MRB standard roller conveyor with track width 400 mm	3669992

Roller and measuring tracks

Optional accessories – extension of the roller and measuring track MRB
Standard for more effective and time-saving work

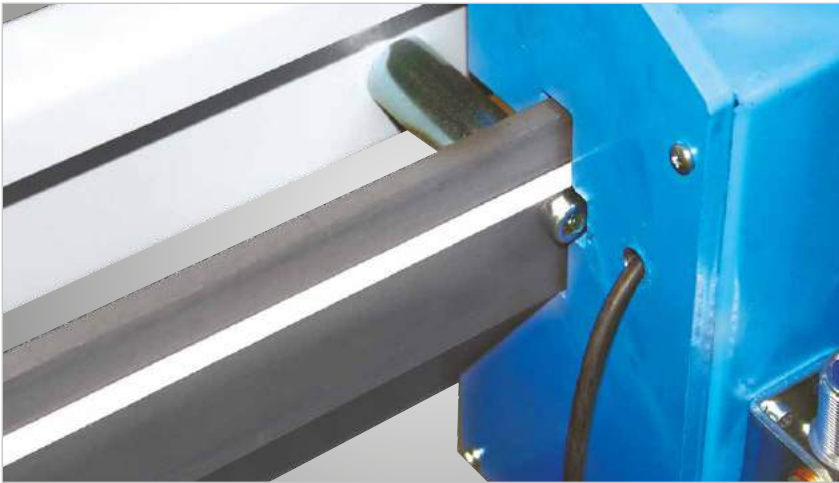

- ▶ Direct magnetic belt measuring system
- ▶ Delivery of direct magnetic belt measuring system including display unit Z58
- ▶ Independent stop carriage and length measuring drives
- ▶ Dimension is displayed via display unit Z58
- ▶ Sensor head mounted directly on the stop carriage
- ▶ Dimensional and repetition accuracy ± 0.1 mm per metre
- ▶ Cable and air ducting via energy drag chain

Length	Art. no.
2 m	3672232
3 m	3672233
4 m	3672234
5 m	3672235
6 m	3672236
7 m	3672237
8 m	3672238



Display unit Z58

- ▶ for convenient reading off of the set values thanks to 1/10 mm LED display
 - ▶ receives the input signals via magnetised pole ring and a sensor head attached directly to the drive shaft
 - ▶ Measuring accuracy of ± 0.2 mm per metre
 - ▶ easy to read off
- Art. no. 3672220

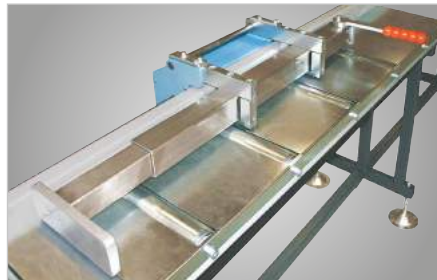

Spring-loaded stop arm SZ 05

- ▶ with spring-loaded material stop arm
 - ▶ adjustable to the 0 point
 - ▶ swivels to the rear manually
 - ▶ equipped with an eccentric lever for adjusting the release action
- Art. no. 3672221

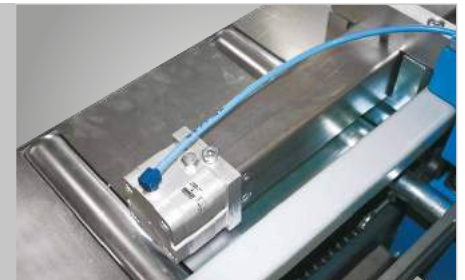

Pneumatic arm retractor

- ▶ **only available in combination with spring loaded stop arm SZ 05**
 - ▶ ideal for mitre cuts
 - ▶ avoids the workpiece skewing
 - ▶ pneumatic arm retraction (release) from the material stop
 - ▶ Release stroke 10 mm
- Art. no. 3672222

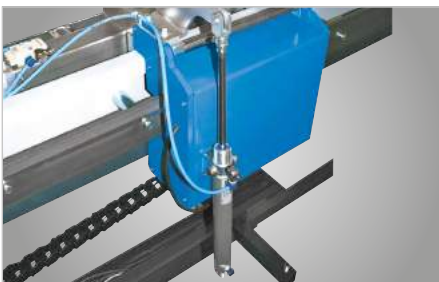

Material arm pneumatically swivelling

- ▶ Device for pneumatically swivelling the material arm to the rear
 - ▶ a pneumatic cylinder handles this task; easy and convenient operation from the central control panel
- Art. no. 3672223



Cover sheet galvanised zinc coated

- ▶ Cover plate for assembly between the idler rollers
 - ▶ galvanised zinc coated
 - ▶ removable
 - ▶ Price per metre of sheet metal
- Art. no. 3672224



Optional roller conveyor feet for table heights up to 1 020 mm

- ▶ Option foot plate with spindle M 16 x 250 mm
 - ▶ Raises the working height up to 1 020 mm
- Art. no. 3679000



Metal-cutting band saws

Metal-cutting band saws

Metal-cutting mitre band saws MBS – particularly quiet and precise. Ideal for use on the construction site and on the road.

- ▶ Ideal for sawing steel, aluminium, copper, PVC and Teflon
- ▶ Continuously adjustable, electronic speed control from 30-80 m/min.
- ▶ Extremely low noise - up to 60% quieter than comparable metal-cutting band saws
- ▶ Low vibration and wear thanks to special gearbox with two large hardened steel gears
- ▶ Guaranteed cutting precision of max. 0.3 mm run-out over 100 mm cut length
- ▶ Each machine is individually precision tested in Italy
- ▶ DC drive motor, low speed and carbon brushes for up to 10x longer service life
- ▶ Electronic temperature and amperage draw monitoring prevents overload
- ▶ Cast band pulleys with ground running surface, without rubber supports, thus suitable for dry and wet cutting
- ▶ Massive saw bow made of cast aluminium (retroactively adjustable as of MBS 125) and with robust transport protection
- ▶ Two moving, adjustable saw band guides with chip scraper made of metal
- ▶ Very stable base plate with anti-slip feet
- ▶ Easy to service as all components are easily accessible



MBS 105



MBS 125



MBS 150

Manual

Technical specifications	MBS 105	MBS 125	MBS 150	MBS 155 K
Art. no.	3630105	3630125	3630150	3630152
Rating	1 010 W	1 010 W	2 000 W	2 000 W
Electrical connection	230 V / 1 Ph ~ 50 Hz			
Saw band speed	30/80 m/min			
Saw band dimensions	1 335 x 13 x 0.65 mm	1 440 x 13 x 0.65 mm	1 735 x 13 x 0.9 mm	1 735 x 13 x 0.9 mm
Dimensions (L x W x H)	630 x 300 x 410 mm	700 x 350 x 410 mm	875 x 420 x 465 mm	1 010 x 420 x 1 335 mm
Weight	20.5 kg	23.5 kg	35 kg	91 kg
Scope of supply	<ul style="list-style-type: none"> • Material stop • Bi-metal saw band M42 T6-10 	<ul style="list-style-type: none"> • Material stop • Bi-metal saw band M42 T6-10 	<ul style="list-style-type: none"> • Material stop • Bi-metal saw band M42 T6-10 	<ul style="list-style-type: none"> • Material stop • Bi-metal saw band M42 T6-10 • Chassis • Coolant system • Coolant channel

Cutting areas MBS 105

	○	●	▭	▮
90°	105	73.5	110 x 60	100 x 105
45°	70	49	65 x 75	70 x 50
60°	-	-	-	-

Cutting areas MBS 125

	○	●	▭	▮
90°	125	87.5	125 x 120	120 x 125
45°	80	56	110 x 70	70 x 110
60°	45	31.5	70 x 40	40 x 70

Cutting areas MBS 150

	○	●	▭	▮
90°	150	105	150 x 140	130 x 150
45°	100	70	120 x 90	90 x 130
60°	55	38.5	70 x 55	55 x 70

Cutting areas MBS 155 K

	○	●	▭	▮
90°	150	105	150 x 140	85 x 160
45°	95	66.5	105 x 90	75 x 130
60°	60	42	65 x 60	60 x 65



- ▶ Two large tempered steel gearwheels for maximum service life
- ▶ DC drive motor, low speed and carbon brushes for up to 10x longer service life



Impressively quiet!

Maximum service life
Continuously variable
30-80 m/min.
Use of coolants possible for
all models



- ▶ Cast wheels with ground running surfaces and tapered roller bearings
- ▶ Without rubber supports and thus suitable for cutting with cooling (saw band does not slip off)
- ▶ Saw band tensioning at front, adjustable via handwheel



- ▶ Dual adjustable saw band guides, instead of just one
- ▶ Swarf scraper made of metal instead of felt to avoid wear



- ▶ Saw bow re-adjustable as of MBS 125



- ▶ Mitre square precisely adjustable; can be read off on scale



- ▶ Continuously variable speed control from 30-80 m/min.



MBS 155 K



Fig. shows MBS 105 on machine chassis MUG 1



Fig. shows MBS 150 on universal work table UWT 3200 with clamped workpiece

Saw bands MBS 105	Art. no.
Bi-metal 1 335 x 13 x 0.65 mm M 42 Z 6-10	3650011
Bi-metal 1 335 x 13 x 0.65 mm M 42 Z 10-14	3650012

Saw bands MBS 150/ MBS 155 K	Art. no.
Bi-metal 1 735 x 13 x 0.65 mm M 42 Z 6-10	3650017
Bi-metal 1 735 x 13 x 0.65 mm M 42 Z 10-14	3650018

Saw bands MBS 125	Art. no.
Bi-metal 1 440 x 13 x 0.65 mm M 42 Z 6-10	3650014
Bi-metal 1 440 x 13 x 0.65 mm M 42 Z 10-14	3650015

Accessories	Art. no.
Universal workbench UWT 3200*	5900020
Machine chassis MUG 1**	3630000
High performance spray "Mecutspray" 500ml	38760.1150
"Chipmag" – Magnetic swarf removal device	3850010

*only fits MBS 150 without installation adapter; adapter Art. no. 3630125-1 required for installation on the MBS 125.

** only fits MBS 105, MBS 125, MBS 150, MTS 356, OPTIsaw S 100G (Optimum)

Saw band sets	Art. no.
for MBS 105	3650020

consisting of:
1 x saw band BI-M 1 335 x 13 x 0.65 t6∠10°
1 x saw band BI-M 1 335 x 13 x 0.65 t6-10
1 x saw band BI-M 1 335 x 13 x 0.65 t10-14

for MBS 125	3650021
consisting of:	
1 x saw band BI-M 1 440 x 13 x 0.65 t6∠10°	
1 x saw band BI-M 1 440 x 13 x 0.65 t6-10	
1 x saw band BI-M 1 440 x 13 x 0.65 t10-14	

MBS 150/155K	3650022
consisting of:	
1 x saw band BI-M 1 735 x 13 x 0.9 t6∠10°	
1 x saw band BI-M 1 735 x 13 x 0.9 t6-10	
1 x saw band BI-M 1 735 x 13 x 0.9 t10-14	



Vertical metal-cutting band saws

VMBS – Vertical metal-cutting band saws with a robust and proven design including band welding unit, e models with electrical table feed

- ▶ Extremely robust design; entire machine body made of steel
- ▶ User-friendly operating concept
- ▶ With workplace lighting
- ▶ Tilting work table made of cast iron
- ▶ Continuously variable speed
- ▶ Band tensioning and band speed display
- ▶ Dust protection system for swarf
- ▶ Integrated band welding unit with annealing, cutting and grinding unit
- ▶ With rip fence

Manual



VMBS 1408



VMBS 1610
 → With 2-gear drive



VMBS 1610 E
 → With 2-gear drive
 → With electric table feed

Models	VMBS 1408	VMBS 1610	VMBS 1610E
Art. no.	3951407	3951610	3951611
Technical data			
Throat	356 mm	396 mm	396 mm
max. cutting height	205 mm	255 mm	255 mm
Table size	500 x 500 mm	550 x 600 mm	550 x 600 mm
Table size additional table	-	-	-
Working height	990 mm	1 000 mm	1 000 mm
Table swivel range left/right	12°/15°	12°/15°	5°/ 5°
Table swivel range front/rear	8°/8°	8°/8°	-
Saw band length	2 880 mm	3 140 mm	3 140 mm
max. saw band width	13 mm	16 mm	16 mm
Saw band speed (1st gear)	20 - 80 m/min	20 - 80 m/min	20 - 80 m/min
Saw band speed (2nd gear)	-	250 - 1 000 m/min	250 - 1 000 m/min
Saw band welding device performance	13 mm	16 mm	16 mm
Wheel Ø	368 mm	408 mm	408 mm
Ø Additional wheel at top	-	-	-
Motor output 400 V / 50 Hz	0.75 kW	1.5 kW	1.5 kW
Table travel	-	-	300 mm
Max. table load	150 kg	150 kg	150 kg
Dimensions	850 x 600 x 1740 mm	940 x 675 x 1840 mm	940 x 675 x 1840 mm
Weight	275 kg	410 kg	435 kg

Saw bands for metal-cutting band saws	Art. no.
VMBS 1408 (bi-metal M 42)	
2 880 x 10 x 0.9 mm 10-14 Vario	3651110
2 880 x 13 x 0.65 mm 6-10 Vario	3651210
2 880 x 13 x 0.65 mm 8-12 Vario	3651212
2 880 x 13 x 0.65 mm 10-14 Vario	3651214
VMBS 1610 / VMBS 1610 E (bi-metal M 42)	
3 140 x 13 x 0.65 mm 6-10 Vario	3651310
3 140 x 13 x 0.65 mm 8-12 Vario	3651312
3 140 x 13 x 0.65 mm 10-14 Vario	3651314

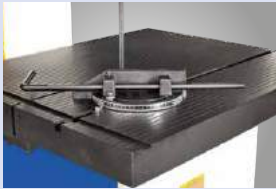

▶ Mitre stop for mitre cuts



▶ Manual material feed



▶ Circle cutting unit

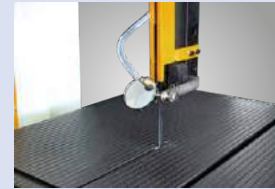

▶ Magnifying glass



▶ Workplace lighting



VMBS 2012 H

- ▶ With 2-gear drive
- ▶ With circle cutting unit
- ▶ With mitre stop for mitre cuts
- ▶ With manual material feed
- ▶ Saw band guide height-adjustable via hand wheel



VMBS 2012 HE

- ▶ With 2-gear drive
- ▶ With electric table feed
- ▶ With circle cutting unit
- ▶ With mitre stop for mitre cuts
- ▶ Saw band guide height-adjustable via hand wheel



▶ Saw band guide height-adjustable via hand wheel



▶ User-friendly operating concept



▶ All models with integrated belt welding unit

Models	VMBS 2012H	VMBS 2012HE
Art. no.	3952011	3952012
Technical data		
Throat	508 mm	508 mm
max. cutting height	305 mm	305 mm
Table size	600 x 700 mm	600 x 700 mm
Table size additional table	-	-
Working height	1 016 mm	1 016 mm
Table swivel range left/right	10°/45°	10°/45°
Table swivel range front/rear	-	-
Saw band length	4 030 mm	4 030 mm
max. saw band width	27 mm	27 mm
Saw band speed (1st gear)	15 - 125 m/min	15 - 125 m/min
Saw band speed (2nd gear)	165 - 1 500 m/min	165 - 1 500 m/min
Saw band welding device performance	19 mm	19 mm
Wheel Ø	515 mm	515 mm
Ø Additional wheel at top	-	-
Motor output 400 V / 50 Hz	2.2 kW	2.2 kW
Table travel	-	300 mm
Max. table load	350 kg	350 kg
Dimensions	1 090 x 810 x 2 030 mm	1 090 x 810 x 2 030 mm
Weight	590 kg	625 kg

Saw bands for metal-cutting band saws	Art. no.
VMBS 2012/ VMBS 2012E (bi-metal M 42)	
4 030 x 13 x 0.65 mm 6-10 Vario	3651710
4 030 x 13 x 0.65 mm 8-12 Vario	3651712
4 030 x 13 x 0.65 mm 10-14 Vario	3651714
4 030 x 20 x 0.9 mm 6-10 Vario	3651720
4 030 x 20 x 0.9 mm 8-12 Vario	3651722
4 030 x 20 x 0.9 mm 10-14 Vario	3651724
4 030 x 27 x 0.9 mm 6-10 Vario	3651730
4 030 x 27 x 0.9 mm 8-12 Vario	3651732
4 030 x 27 x 0.9 mm 10-14 Vario	3651734

Vertical metal-cutting band saws

VMBS – Vertical metal-cutting band saws with a robust and proven design including band welding unit, e models with electrical table feed

- ▶ Extremely robust design; entire machine body made of steel
- ▶ User-friendly operating concept
- ▶ With workplace lighting
- ▶ Tilting work table made of cast iron
- ▶ Continuously variable speed
- ▶ Band tensioning and band speed display
- ▶ Dust protection system for swarf
- ▶ Integrated band welding unit with annealing, cutting and grinding unit
- ▶ With rip fence

Manual



VMBS 2613

- ➔ With 2-gear drive
- ➔ With circle cutting unit
- ➔ With mitre stop for mitre cuts
- ➔ With manual material feed
- ➔ Saw band guide height-adjustable via hand wheel



VMBS 2613E

- ➔ With 2-gear drive
- ➔ With electric table feed
- ➔ With circle cutting unit
- ➔ With mitre stop for mitre cuts
- ➔ Saw band guide height-adjustable via hand wheel

Models	VMBS 2613	VMBS 2613E
Art. no.	3952612	3952613
Technical data		
Throat	658 mm	658 mm
max. cutting height	330 mm	330 mm
Table size	600 x 700 mm	600 x 700 mm
Table size additional table	-	-
Working height	1 000 mm	1 000 mm
Table swivel range left/right	10°/45°	10°/45°
Table swivel range front/rear	-	-
Saw band length	4 680 mm	4 680 mm
max. saw band width	27 mm	27 mm
Saw band speed (1st gear)	15 - 125 m/min	15 - 125 m/min
Saw band speed (2nd gear)	165 - 1 500 m/min	165 - 1 500 m/min
Saw band welding device performance	19 mm	19 mm
Wheel Ø	665 mm	665 mm
Ø Additional wheel at top	-	-
Motor output 400 V / 50 Hz	2.2 kW	2.2 kW
Table travel	-	300 mm
Max. table load	350 kg	350 kg
Dimensions	1 340 x 810 x 2190 mm	1 340 x 810 x 2190 mm
Weight	665 kg	710 kg

Saw bands for metal-cutting band saws	Art. no.
VMBS 2613 / VMBS 2613 E (bi-metal M 42)	
4 680 x 13 x 0.65 mm 6-10 Vario	3651810
4 680 x 13 x 0.65 mm 8-12 Vario	3651812
4 680 x 13 x 0.65 mm 10-14 Vario	3651814
4 680 x 20 x 0.9 mm 6-10 Vario	3651820
4 680 x 20 x 0.9 mm 8-12 Vario	3651822
4 680 x 20 x 0.9 mm 10-14 Vario	3651824
4 680 x 27 x 0.9 mm 6-10 Vario	3651830
4 680 x 27 x 0.9 mm 8-12 Vario	3651832
4 680 x 27 x 0.9 mm 10-14 Vario	3651834

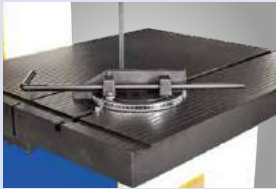

▶ Mitre stop for mitre cuts



▶ Manual material feed



▶ Circle cutting unit

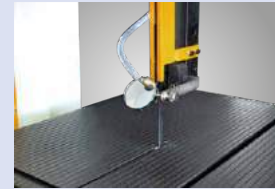

▶ Magnifying glass



▶ Workplace lighting



VMBS 3612

- ➡ With 2-gear drive
- ➡ With circle cutting unit
- ➡ With mitre stop for mitre cuts
- ➡ With manual material feed
- ➡ Saw band guide height-adjustable via hand wheel



VMBS 3612E

- ➡ With 2-gear drive
- ➡ With electric table feed
- ➡ With circle cutting unit
- ➡ With mitre stop for mitre cuts
- ➡ Saw band guide height-adjustable via hand wheel

Models	VMBS 3612	VMBS 3612E
Art. no.	3953611	3953612
Technical data		
Throat	915 mm	915 mm
max. cutting height	305 mm	305 mm
Table size	600 x 700 mm	600 x 700 mm
Table size additional table	450 x 700 mm	450 x 700 mm
Working height	1 016 mm	1 016 mm
Table swivel range left/right	10°/45°	10°/45°
Table swivel range front/rear	-	-
Saw band length	5 020 mm	5 020 mm
max. saw band width	27 mm	27 mm
Saw band speed (1st gear)	15 - 125 m/min	15 - 125 m/min
Saw band speed (2nd gear)	165 - 1 500 m/min	165 - 1 500 m/min
Saw band welding device performance	19 mm	19 mm
Wheel Ø	515 mm	515 mm
Ø Additional wheel at top	368 mm	368 mm
Motor output 400 V / 50 Hz	2.2 kW	2.2 kW
Table travel	-	-
Max. table load	350 kg	350 kg
Dimensions	1 760 x 810 x 2 060 mm	1 760 x 810 x 2 060 mm
Weight	800 kg	835 kg

Saw bands for metal-cutting band saws Art. no.

VMBS 3612 / VMBS 3612 E (bi-metal M 42)

5 020 x 13 x 0.65 mm 6-10 Vario	3651910
5 020 x 13 x 0.65 mm 8-12 Vario	3651912
5 020 x 13 x 0.65 mm 10-14 Vario	3651914

5 020 x 20 x 0.9 mm 6-10 Vario	3651920
5 020 x 20 x 0.9 mm 8-12 Vario	3651922
5 020 x 20 x 0.9 mm 10-14 Vario	3651924

5 020 x 27 x 0.9 mm 6-10 Vario	3651930
5 020 x 27 x 0.9 mm 8-12 Vario	3651932
5 020 x 27 x 0.9 mm 10-14 Vario	3651934

Metal-cutting band saws

The various heavy-duty, industrial type metal-cutting band saw operating concepts - user friendly and clear cut



BMBS 230 x 280 H-DG



BMBS 300 x 320 CNC-G



BMBS 300 x 320 HA-DG



HMBS 500 x 750 HA-DG-X



Explanation of the various equipment and accessory details:

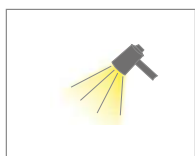

Workplace lighting

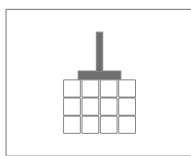

hydr. bundle clamping unit

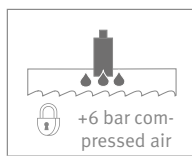

Micro-spraying system
+6 bar compressed air

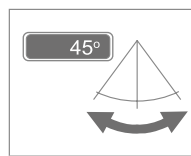

Digital angle display on saw arm

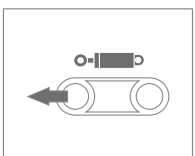

Hydraul. band tensioning unit

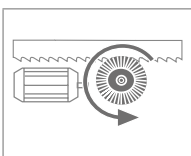

Motorised swarf brush

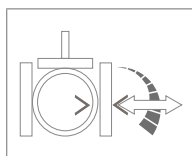

Pressure regulator on vice

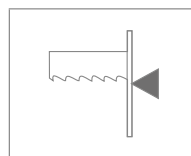

Display for lowering speed at control panel (mm/min)

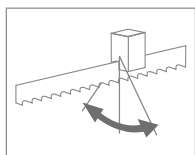

Cut path monitoring

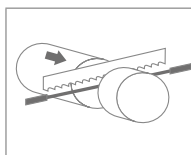

Material start sensor

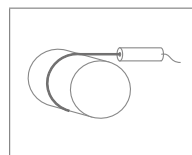

Cutting line laser

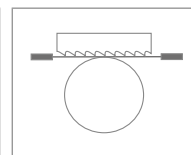

Autom., zero-contact setting of upper working position



Explanation of the METALLKRAFT designations
Metal-cutting band saws with heavy-duty industrial design

BMBS	Swivel frame Metal Band Saws
HMBS	Horizontal Metal Band Saws
HVMS	Horizontal/Vertical Metal-cutting Band Saws
G	Machine cuts simple mitres (G)
DG	Machine cuts Double mitres (G)
H	Saw with partially hydraulically controlled functions
HA	(H) Semi-Automatic machine
NC	Partially automated NC operation
CNC	Automated CNC operation
X	advanced electronics taking the material properties into consideration



Commissioning & professional initial training

When purchasing a Metallkraft machine, we recommend that customers call in one of our specialists to complete commissioning and provide induction training on site.

Commissioning and initial training for standard machines	Art. no. EINWMET
Initial training & training for CNC controls	EINWCNCMET
Duration of commissioning and initial training for custom machines*	EINWGBPMET

* DBM, MBBS, FSM, HTBS, MSBM Pro, controlled PRM and MRB, GBP, LMS 400A and metal band saws with X-control

Commissioning includes:

- Installing the machine
- (Unloading and transporting the machine to the installation location; providing the electrical and pneumatic connections, and the floor anchors or assembly plates are the purchaser's responsibility.)
- Cleaning, tooling and aligning
- Checking all functions

Initial training on the machine includes:

- an exhaustive explanation of the controls
- an explanation of the individual functions
- Setting and explaining the basic parameters
- Explaining the safety instructions as per best practices

For programmable models, additionally:

- an exhaustive explanation of the controls
- an explanation of the individual functions
- Setting and explaining the basic parameters
- Explaining the safety instructions as per best practices

Duration of commissioning and initial training: 8 hours per day, including travel times to and from the site, plus travel expenses at €0.69 per km, plus any charges for overnight stays as applicable.

If the initial training time is 8 hours, the travel time is invoiced at €48 /hour.

This also applies for any different or additional services, which must be ordered separately on site and will be invoiced on individual basis.

If the customer requires and requests installation and connecting of the machine, the customer is obliged to support our technician to the best of customer's ability and to provide the required helpers, tools and equipment at customer's own expense.

The control panel on our H models

Function of our H models:

The Version H saws have a hydraulic cylinder that controls lowering of the saw arm. The operator can switch between manual mode and gravity mode with a selector switch. In manual mode,

the sawing arm is lowered by hand. In gravity mode, the sawing action is started by pressing a pushbutton; the saw arm is lowered through its own weight; the lowering speed can be regulated using a choke valve under the control panel.

The cut is executed at the selected band speed, and the saw band stops automatically after completing the cutting action. The saw arm is always lifted manually. The lowering cylinder automatically shuts off on reaching the top end position.

Standard

- ▶ Check lamp for saw band tension:
- lit green when the band tension is correct and the saw band cover is closed

- ▶ Start of cycle - pressing the button starts the sawing action.

- ▶ Switch for switching the mode
Work mode switches between manual and gravity mode (lowering of the saw arm through its own weight)

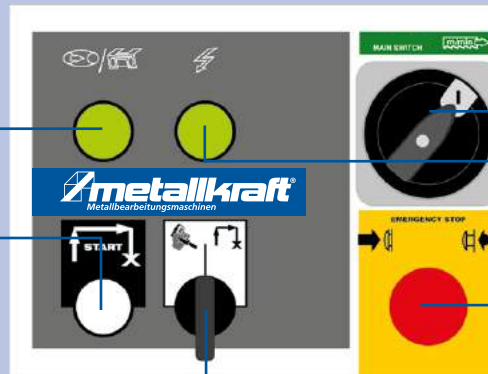

- ▶ Switch for selecting the band speed in 2 stages, e.g.: Position 1: 35 m/min., Position 2: 70 m/min.
- ▶ This switch is the main switch at the same time

- ▶ Indicator lamp shows whether the machine is switched on at the main switch

- ▶ Emergency off switch - switches the machine off during a cycle

BMBS 300 x 320 H-DG

- ▶ Switch for selecting the belt speed in 2 stages, e.g.,:
Position 1: 35 m/min.
Position 2: 70 m/min.

- ▶ Check lamp for saw band tension:
- lit green when the band tension is correct and the saw band cover is closed

- ▶ Start of cycle - pressing the button starts the sawing action.

- ▶ RESET button

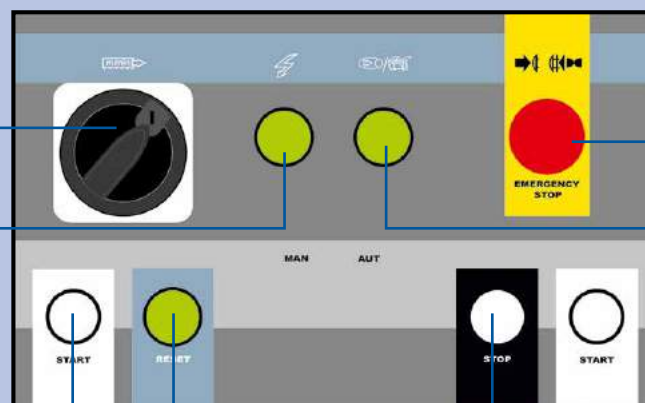

- ▶ Emergency off switch - switches the machine off during a cycle

- ▶ Indicator lamp shows whether the machine is switched on at the main switch

- ▶ Stop switch - switches the machine off during a cycle

Metal-cutting band saw controls

The control panel on the semi-automatic machines (HA)

Function of the semi-automatic machines:

The Version HA sawing machine have hydraulic functions that support a semi-automatic mode of operation. After starting the machine, the vice automatically clamps the workpiece. The saw cut

is performed at the selected band speed. The lowering motion automatically stops at the bottom end position; the saw arm moves to its top end position. The vice opens automatically so that the operator only needs to move the material.

The sawing action can be interrupted at any time by enabling the stop function. The band is freed and the saw arm moves out of the cutting channel without opening the vice or switching off the machine.

- ▶ Large digital display with functions such as:
 1. MENU button for actuating the various menu items shown on the screen
 2. Workpiece/cut counter
 3. BRP display*
 4. Hydraulic system status display
 5. Saw band tension display
 6. Saw arm position display
 7. Saw band speed display

- ▶ Start of cycle - pressing the button starts the saw's processing cycle. The saw arm must be in the top end position for this to happen.
- ▶ Vice control - if the vice is still open before the cycle starts, the control unit automatically closes it after starting the cycle, and opens it again after completing the work step.

- ▶ Saw arm control - controls the up and down motion of the saw arm

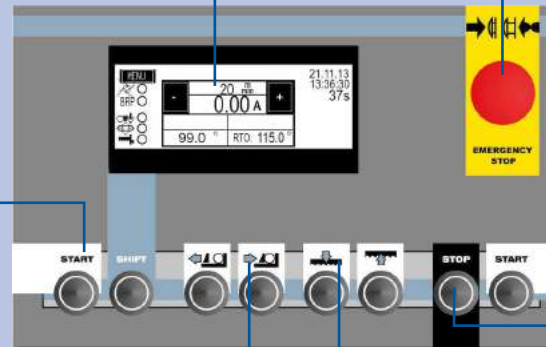

- ▶ Emergency off switch - switches the machine off during a cycle

Control field

START

- ▶ in semi-automatic mode, for starting the cut
- ▶ For safety reasons, both start buttons must be pressed at the same time

STOP

- ▶ Interrupts the cut in any position
- ▶ The cycle continues after pressing the Start button

*BRP - saw band monitoring

The BRP display is activated if a maximum value of the saw band motor in Amperes is exceeded. The sawing frame stops the feed motion while the saw band continues to run and discharges the swarf from the cutting channel. Once the load on the saw band has been reduced to a minimum, the sawing process continues normally.

The control panel on the semi- and fully-automatic CNC versions

Saws with CNC control can be operated in semi- and fully-automatic mode.

Function of the semi-automatic machines:

In semi-automatic mode, the saw works as stated in the function description for semi-automatic machines.

Fully-automatic operating mode:

Nine different tasks can be programmed on the fully-automatic CNC versions. The program contains the steps and cut lengths for each task. The work steps for feeding in the material are automatically computed by a processor. It is possible to call up

various cutting sequences and automatically run programs with different cutting lengths one after another.

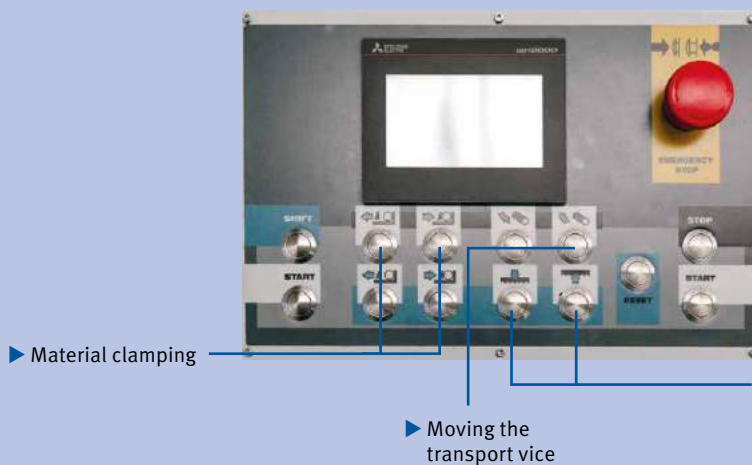

- ▶ Material clamping

- ▶ Moving the transport vice

- ▶ Height adjustment of saw frame

Large display

- ▶ The values selected in the information display are shown here.
- ▶ Control field

START

- ▶ in semi-automatic mode, for starting the cut
- ▶ For safety reasons, both start buttons must be pressed at the same time

STOP

- ▶ Interrupts the cut in any position
- ▶ The cycle continues after pressing the Start button

*BRP - saw band monitoring

The BRP display is activated if a maximum value of the saw band motor in Amperes is exceeded. The sawing frame stops the feed motion while the saw band continues to run and discharges the swarf from the cutting channel. Once the load on the saw band has been reduced to a minimum, the sawing process continues normally.

The control panel on the semi-automatic HA-X models

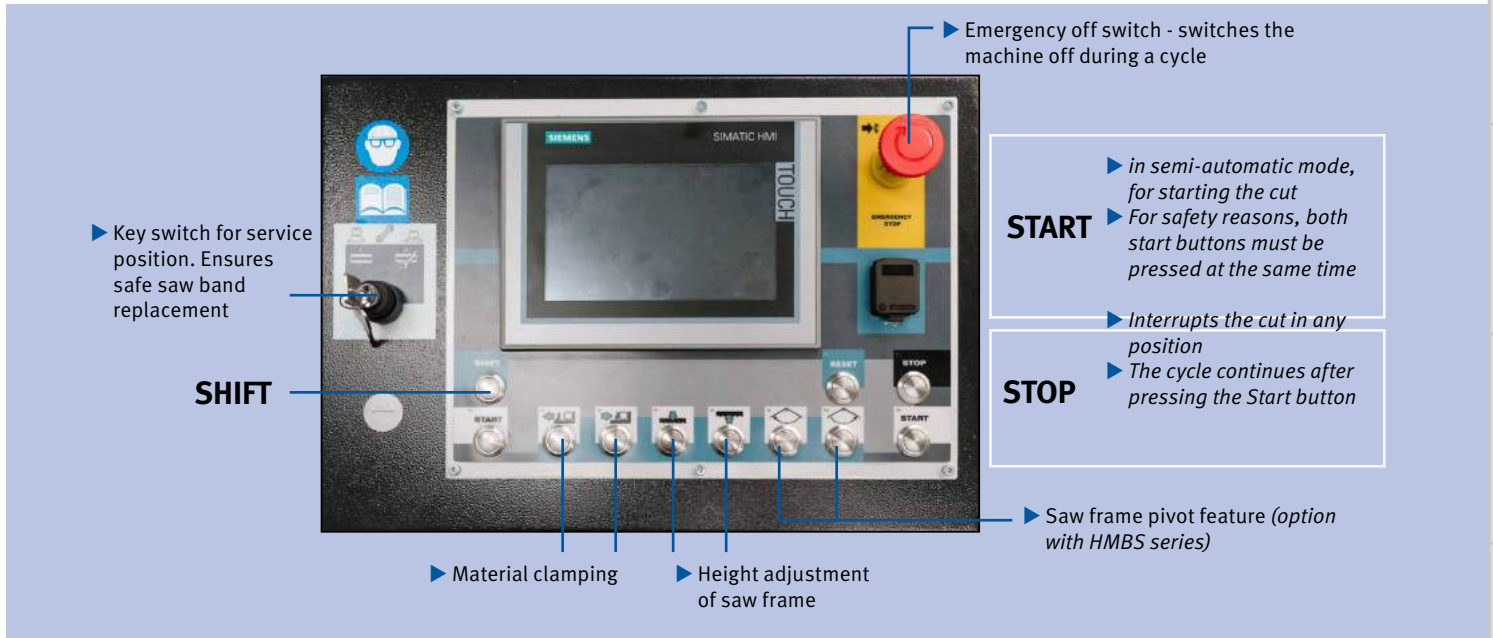

Function of the ARP system for high precision cuts and a long service life

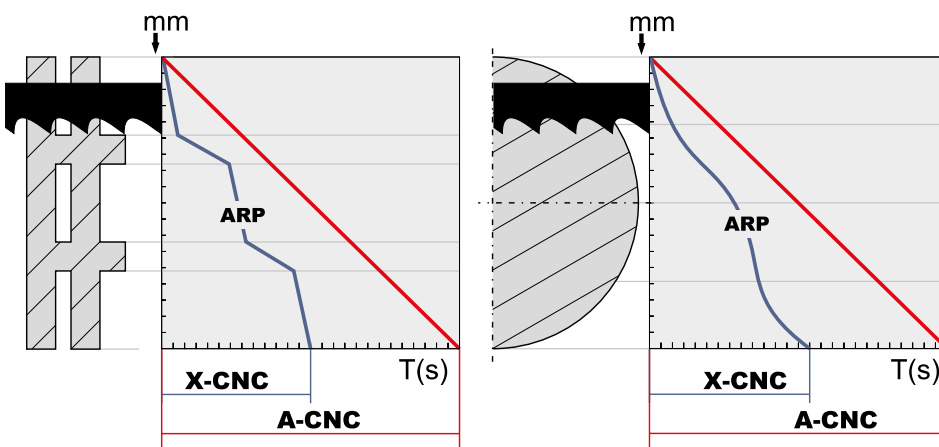

The ARP system ensures automatic control of saw arm movements depending on the material's current cutting resistance value based on the cutting forces that occur. As the resistance increases, the ARP system automatically reduces the lowering speed, thus ensuring optimum cutting results with a high degree of angular precision.

As the resistance drops, the ARP accelerates the lowering speed. The automatically optimised lowering speed automates the work process and increases the saw blade's service life. The ARP system is delivered with all X version saws. **This helps you save money with improved cutting results, and you benefit from the improved saw band service life.**



Metal-cutting band saw controls

The control panel of our X models for 90° cuts

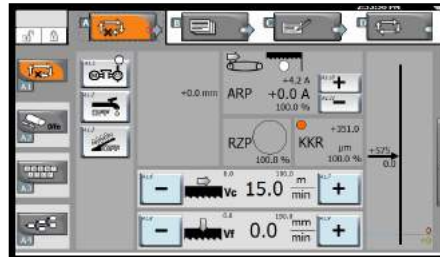
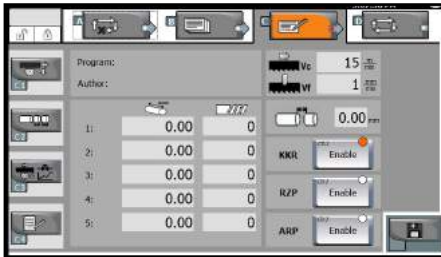
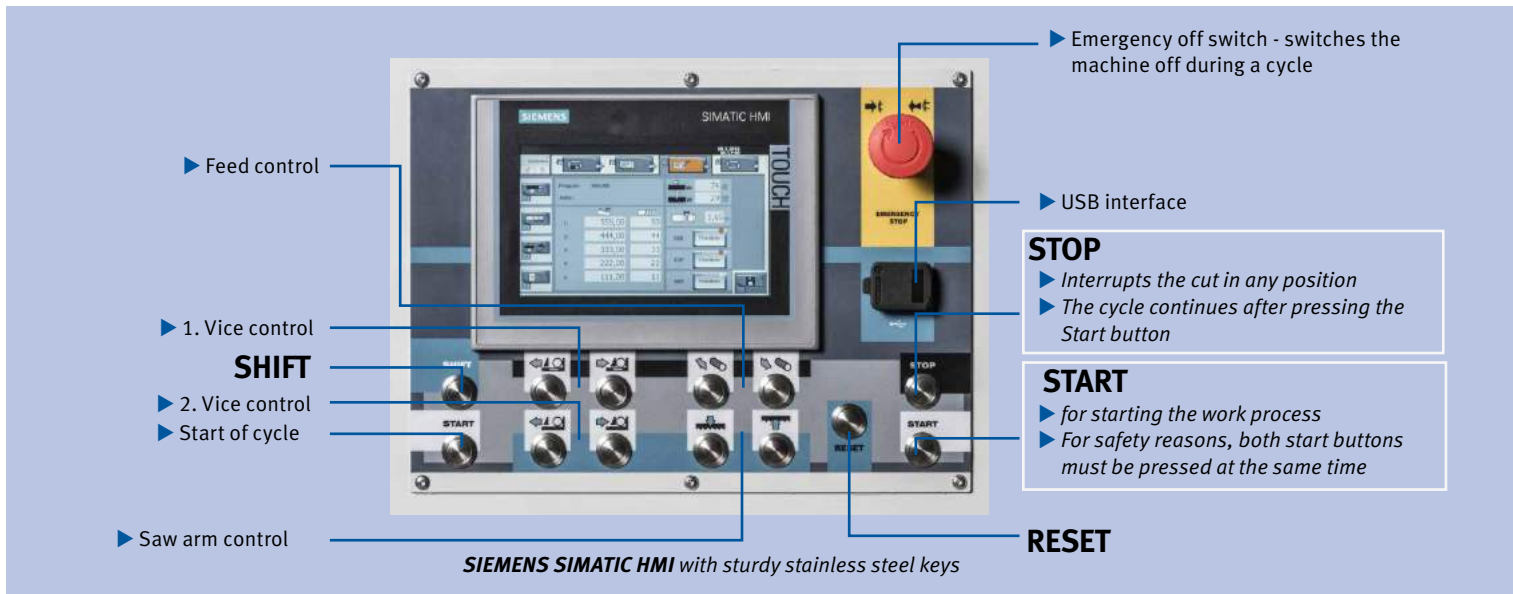

User-friendly environment:

- ▶ The control system communicates with the machine operator in the operator's native language
- ▶ Graphical touchscreen with intuitive control and understandable pictograms
- ▶ Four windows for optimising the required parameters for a quick start of operations

Technical description

- ▶ Data transmission option via the USB interface
- ▶ Multiple access levels protected by user accounts
- ▶ Easy uploading of new software versions

Function description:

- ▶ The control system supports creating up to 1 000 programs with cutting parameters. Each program can be quickly found with a search filter (depending on the quality of the material, order number, number of workpieces, cut lengths, cutting data and much more).
- ▶ **KKR mode (option):** Cutting path control permanently measures the straightness of the cut
- ▶ **ARP mode:** The automatic cut feed control has been further optimised so that the operator only need to set the load stages (Amperes) during the cut. We recommend using this function when cutting materials with different wall thicknesses (cross cut).

- ▶ **RZP mode:** Cut feed control by setting the cutting zones to match the cross-section shape and size of the material to be processed (recommended with HM saw bands)
- Setting up the material feed:**
 - ▶ Normal, staged, TOF (= incremental), CMU (= feed with automatic opening of the cutting zone)
- Improved GTO mode:**
 - ▶ Feed to the selected position. Functions: ABS, REL, ATB
- ATB mode:**
 - ▶ Automatic movement of the material into the cutting zone, without needing to perform a pilot cut after inserting new material into the machine.

! Available as a factory option for the models HMBS 300 x 300 CNC, HMBS 400 x 400 CNC, HMBS 510 x 510 CNC, HMBS 700 x 750 CNC, HMBS 850 x 1 000 CNC:

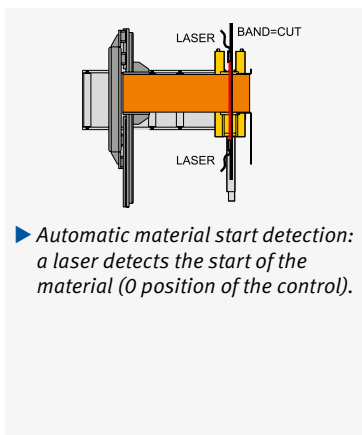
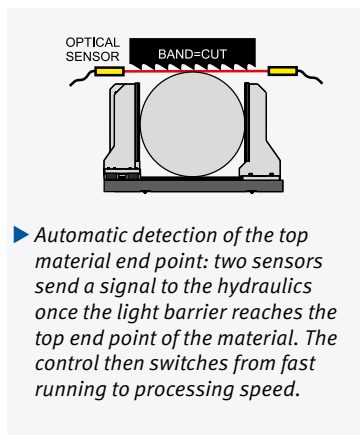
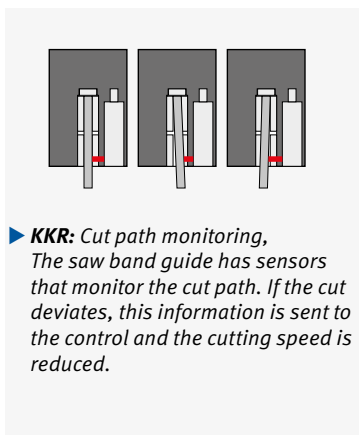
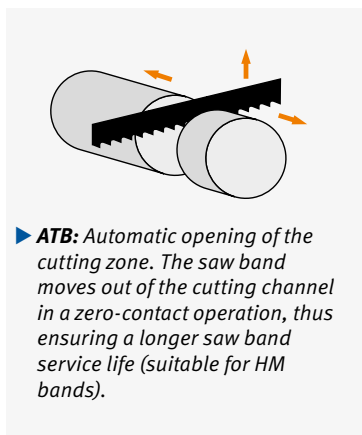

The control panels on our H models



BMBS 220 x 250 H-G

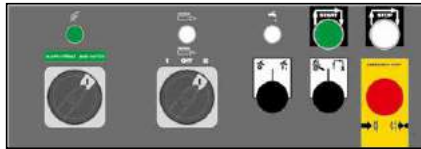

BMBS 250 x 315 H-DG

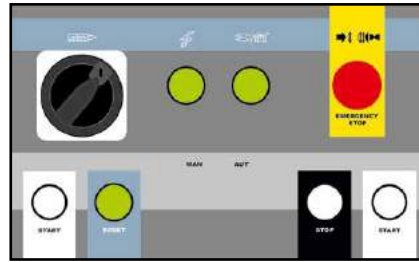

BMBS 300 x 320 H-DG

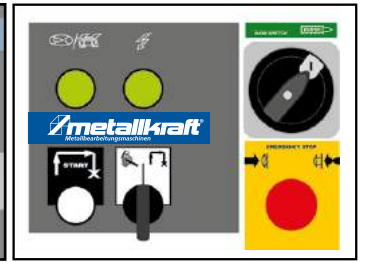

BMBS 230 x 280 H-DG

The control panels on our HA models

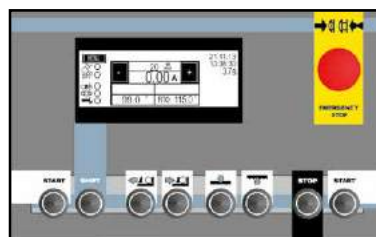

BMBS 230 x 280 HA-DG
BMBS 300 x 320 HA-DG
BMBS 460 x 600 HA-DG



BMBS 250 x 315 HA-DG

The control panels on our CNC models



BMBS 230 x 280 CNC
BMBS 300 x 320 CNC
HMBS 400 CNC
HMBS 360 x 500 CNC

The control panels on our X models



HMBS 300 x 300 CNC X
HMBS 340 CNC-DG-X
HMBS 400 x 400 CNC X
HMBS 510 x 510 CNC X
HMBS 700 x 750 HA X
HMBS 700 x 750 CNC X



HMBS 500 x 750 NC-DG X BC 2000
HMBS 500 x 750 HA-DG X

HMBS 850 x 1000 CNC X
HMBS 5000 CNC X
HVMB 850 x 1000 Xtreme
HMBS 1200 x 1400 HA X
HVMB 1200 x 1600 Xtreme

BMBS 220 x 250 H-G

Hydraulic swivel frame metal-cutting band saw for mitre cuts of up to +60°.

- ▶ For sawing, e.g., stainless steel, tool steel, hollow sections and full materials
- ▶ Horizontally swivelling saw arm
- ▶ Two-pole drive motor supports saw band speeds of 30 and 65 m/min
- ▶ Saw band tension monitoring - electro-mechanically via micro-switches
- ▶ When the saw arm lifts, the solenoid valve locks the lowering cylinder in top position, thus removing the need for additional locking on the cylinder
- ▶ Saw arm tilted by 25° for a longer saw band service life
- ▶ Precise and sturdy band guides with adjustable tungsten carbide plates
- ▶ After completing the cutting action, the saw band automatically stops in the bottom end position.
- ▶ Saw arm lowering through gravity or manually
- ▶ With continuously variable, constant saw arm lowering speed via hydraulic cylinder



! For an exhaustive explanation of the controls, see pages 227 – 231



BMBS 220 x 250 H-G

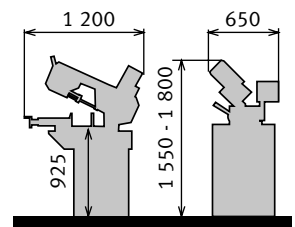

! We are always happy to perform sample cutting for your material. Call us for details!





Scope of delivery:

- › Saw band
- › Coolant pump
- › Operating tool
- › Adjustable stop

Model	BMBS 220 x 250 H-G
Art. no.	3680001

Technical specifications	
Motor output 3 x 400 V/50 Hz	0.75-1.1 kW
Speed stages	2
Saw band speeds	30 / 65 m/min
Saw band dimensions	2 450 x 27 x 0.9 mm
Dimensions (L x W x H)	1 200 x 650 x 1 800 mm
Table height material feed	925 mm
Weight	270 kg

Clamping ranges

mm	0°	45°	60°	 $\frac{b}{a \times b}$
	220	160	90	X
	120 *	85 *	55 *	X
	230 x 190	160 x 90	90 x 90	230 x 120

* recommended values

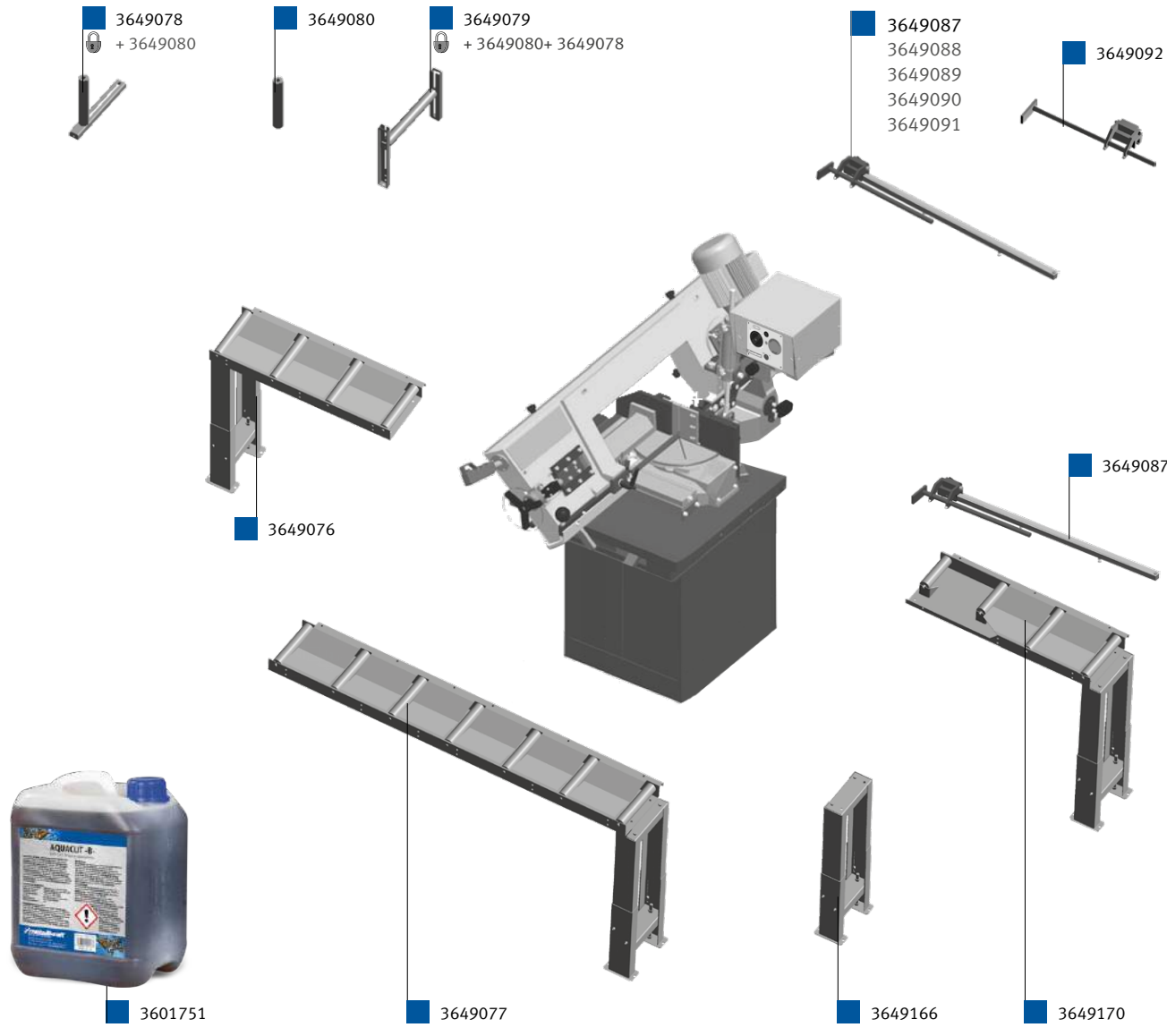
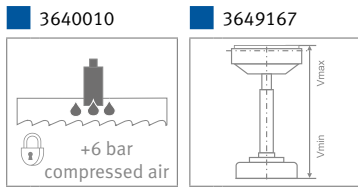

Optional accessories (only available from factory)	Art. no.
Motor + gearbox for cutting stainless steel (23/46 m/min.)	3640076
Roller conveyors 290 mm (incl. legs)	
1 000 x 290 mm, roller conveyor 200 kg/m	3649076
2 000 x 290 mm, roller conveyor 200 kg/m	3649077
Connecting roller conveyor f. 60° cuts between saw and roller conveyor incl. connecting parts	3649170
M42 saw bands	
2 450 x 27 x 0.9 mm 5-8 TPI Sprint	3655122
2 450 x 27 x 0.9 mm 10-14 TPI Sprint	3655123
2 450 x 27 x 0.9 mm 3-4 TPI Sprint Plus	3655120
2 450 x 27 x 0.9 mm 2-3 TPI Sprint Plus	3655121
2 450 x 27 x 0.9 mm 4-6 TPI Sprint-Medium-VS	3655119
2 450 x 27 x 0.9 mm 3-4 TPI X-FIT (PU=5)	3655800
2 450 x 27 x 0.9 mm 4-6 TPI X-FIT (PU=5)	3655801

Accessories, roller conveyors 290 mm	Art. no.
Coolant concentrate 5 l	3601751
Spraying agent 5 l, micro-dosing unit	3608020
lateral Steering roll 200 mm, mobile	3649078
(requires: 3649080*)	
lateral Guide roller 200 mm, rigid	3649080
Horizontal bundle clamping roller 290 mm	3649079
(requires: 3649080* + 3649078*)	
Additional leg for increasing the load bearing capacity	3649166
Roller support, height-adjustable, width 290 mm, load-bearing capacity 200 kg	3649167
Roller support, height-adjustable, width 280 mm, load-bearing capacity 100 kg	3649169
1 m folding stop with measuring scale	3649087
2 m folding stop with measuring scale	3649088
3 m folding stop with measuring scale	3649089
4 m folding stop with measuring scale	3649090
5 m folding stop with measuring scale	3649091
additional stop	3649092

*** must be ordered with your order!**

When ordering a roller conveyor, always state whether you need a feed or discharge conveyor

More saw bands and info on Page 283

Magnetic drilling
Deburring
Metal grinding
Cutting
Notching & punching
Bending
Presses
Circular saws
Roller conveyors
Metal-cutting band saws

BMBS 230 x 280 H-DG / BMBS 230 x 280 HA-DG

Hydraulic swivel frame metal-cutting band saw for mitre cuts from +60° to -45°, HA version fully-hydraulic with semi-automatic mode of operation

- ▶ For sawing, e.g., stainless steel, tool steel, hollow sections and full materials
- ▶ Precise and sturdy band guides with adjustable tungsten carbide plates
- ▶ Saw band tension monitoring - electro-mechanically via micro-switches
- ▶ with cooling system on the saw band guides
- ▶ with swarf clearing brush for optimum cleaning and maintenance of the saw band
- ▶ When the saw arm lifts, the solenoid valve locks the lowering cylinder in top position, thus removing the need for additional locking on the cylinder (H-DG)
- ▶ Continuously variable band speed (HA-DG)
- ▶ Saw arm tilted by 25° for a longer saw band service life
- ▶ After completing the cutting action, the saw band automatically stops
- ▶ Saw arm lowering manually or through deadweight (H-DG)
- ▶ BRP - saw band monitoring (HA-DG)
- ▶ After starting the cutting cycle, the vice automatically clamps - after completing the action, it returns to its original position (HA-DG)
- ▶ Turntable for mitre adjustment

Manual

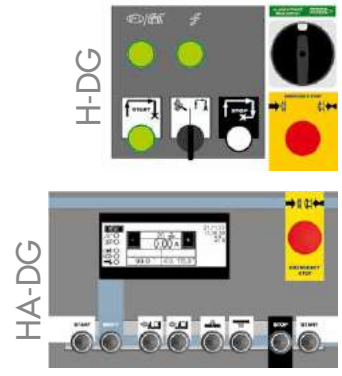

! For an exhaustive explanation of the controls, see pages 227 – 231



BMBS 230 x 280 H-DG



BMBS 230 x 280 HA-DG

Clamping ranges

mm	0°	45°	60°	45°	a x b
	230	195	125	185	X
	150 *	110 *	80 *	110 *	X
	280 x 180	180 x 170	120 x 110	180 x 120	180 x 120

* recommended values

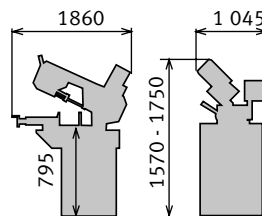

Model	BMBS 230 x 280 H-DG	BMBS 230 x 280 HA-DG
Art. no.	3680013	3690026
Technical specifications		
Motor output 3 x 400 V/50 Hz	0.75-1.1 kW	1.5 kW
Speed stages	2	Continuously variable
Saw band speeds	35 / 70 m/min	20 - 100 m/min
Saw band dimensions	2 720 x 27 x 0.9 mm	2 720 x 27 x 0.9 mm
Dimensions (L x W x H)	1 650 x 885 x 1860 mm	1860 x 1 045 x 1750 mm
Table height material feed	795 mm	795 mm
Weight	280 kg	395 kg
min. remaining workpiece length	22 mm	22 mm

Scope of delivery:

- ▶ Saw band
- ▶ Coolant pump
- ▶ Operating tool
- ▶ Vice with quick release
- ▶ Cut probe (HA-DG)
- ▶ Swivelling control panel (HA-DG)

! We are always happy to perform sample cutting for your material. Call us for details!

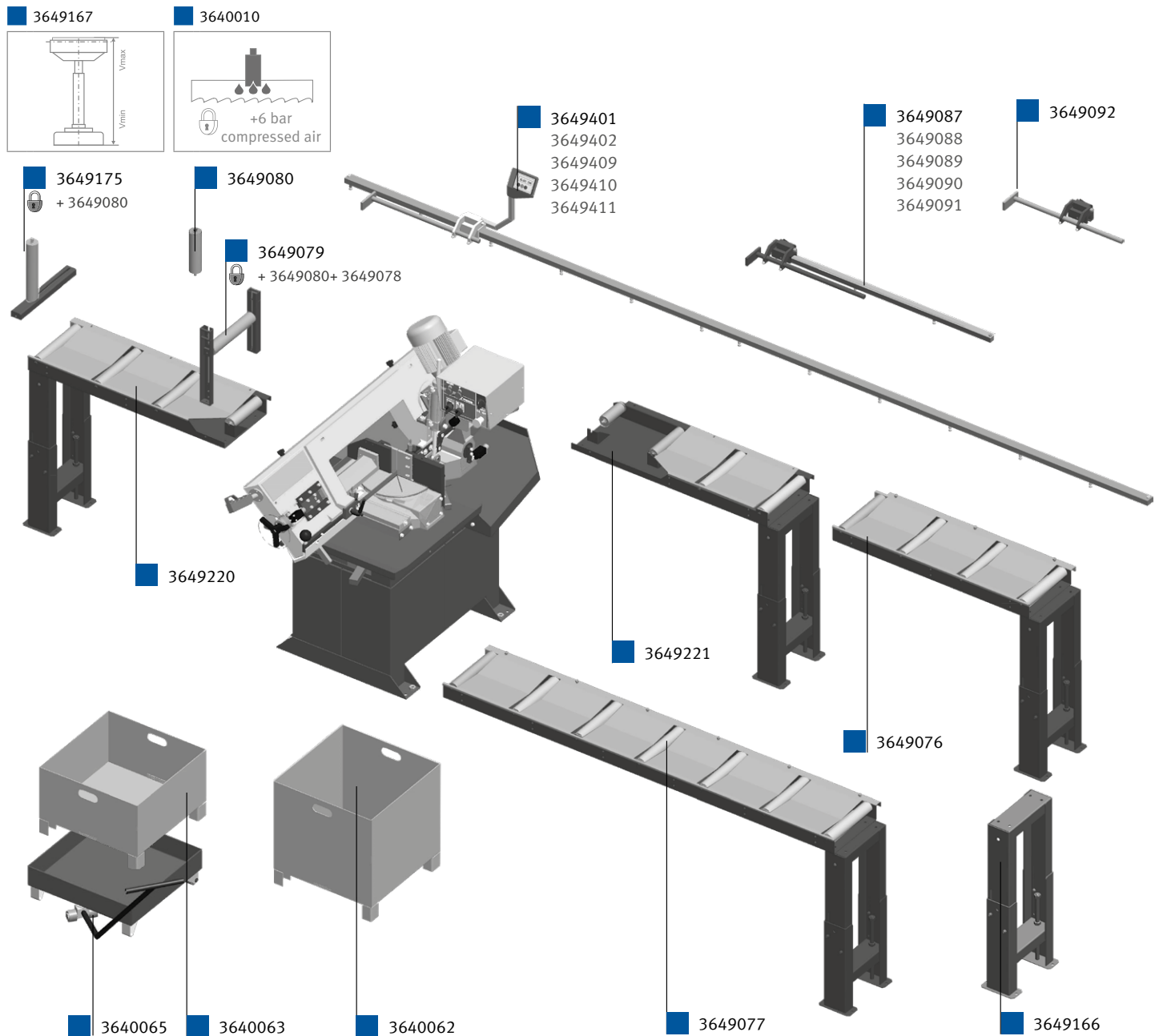

Optional accessories (only available from factory)	Art. no.	Accessories, roller conveyors 290 mm	Art. no.
Micro-spraying system	3640010	Coolant concentrate 5 l	3601751
Accessories		Spraying agent 5 l, micro-dosing unit	3608020
Workpiece container	3640062	2 m folding stop with measuring scale (requires: 3649077*)	3649088
Swarf container	3640063	3 m folding stop with measuring scale	3649089
Trolley for swarf container and workpiece container	3640065	4 m folding stop with measuring scale	3649090
Roller conveyor width 290 mm		5 m folding stop with measuring scale	3649091
1 000 x 290 mm, roller conveyor 200 kg/m	3649076	additional stop	3649092
2 000 x 290 mm, roller conveyor 200 kg/m	3649077	1 m stop with digital measuring display	3649401
Connecting roller conveyor 1 000 x 290 mm feed side	3649220	2 m stop with digital measuring display	3649402
Connecting roller conveyor 1 000 x 290 mm discharge side	3649221	3 m stop with digital measuring display	3649409
Accessories, roller conveyors 290 mm		4 m stop with digital measuring display	3649410
lateral Steering roll 200 mm, mobile (requires: 3649080*)	3649078	5 m stop with digital measuring display	3649411
lateral Guide roller 200 mm, rigid	3649080	Saw bands	
Horizontal bundle clamping roller 290 mm (requires: 3649080* + 3649078*)	3649079	2 720 x 27 x 0.9 mm 5-8 TPI M42 Sprint	3655508
Additional leg for increasing the load bearing capacity	3649166	2 720 x 27 x 0.9 mm 6-10 TPI M42 Sprint	3655510
Roller support, height-adjustable, width 290 mm, load-bearing capacity 200 kg	3649167	2 720 x 27 x 0.9 mm 10-14 TPI M42 Sprint	3655514
1 m folding stop with measuring scale (requires: 3649076*)	3649087	2 720 x 27 x 0.9 mm 2-3 TPI M42 Sprint Plus	3655603
		2 720 x 27 x 0.9 mm 3-4 TPI M42 Sprint Plus	3655604
		2 720 x 27 x 0.9 mm 4-6 TPI M42 Sprint-Medium-VS	3655606
		2 720 x 27 x 0.9 mm 2-3 TPI M51 Sprint Plus	3655703
		2 720 x 27 x 0.9 mm 3-4 TPI M51 Sprint Plus	3655704
		2 720 x 27 x 0.9 mm 4-6 TPI M51 Sprint Plus	3655706
		2 720 x 27 x 0.9 mm 3-4 TPI X-FIT (PU=5)	3655805
		2 720 x 27 x 0.9 mm 4-6 TPI X-FIT (PU=5)	3655806

More saw bands and info on Page 283

When ordering a roller conveyor, always state whether you need a feed or discharge conveyor

* must be ordered with your order!

Magnetic drilling
Deburring
Metal grinding
Cutting
Notching & punching
Bending
Presses
Circular saws
Roller conveyors
Metal-cutting band saws

Automatic pivot frame metal-cutting band saw for mitre cuts from 0° to +60° right

Automatic

- ▶ For sawing, e.g., stainless steel, tool steel, hollow sections and full materials
- ▶ Precise and sturdy band guides with adjustable tungsten carbide plates
- ▶ Hydraulically controlled system for both vises, and the saw arm's up and down motion
- ▶ Material feed via ball screw
- ▶ With swarf clearing brush for optimum cleaning and maintenance of the saw band
- ▶ Saw arm tilted by 25° for a longer saw band service life
- ▶ BRP - saw band monitoring
- ▶ The jaws on the two vises are equipped with long stroke hydraulic cylinders as standard; this removes the need to preset to the material cross-section to be cut
- ▶ With pivoting cutting gap for mitre adjustment -> thus avoiding cutting the saw table



! For an exhaustive explanation of the controls, see pages 227 – 231



! We are always happy to perform sample cutting for your material. Call us for details!

Scope of delivery:

- > Saw band
- > Operating tool
- > Vice with quick release

Model	BMBS 230 x 280 CNC-G
Art. no.	3690053

Technical specifications	
Motor output 3 x 400 V/50 Hz	1.5 kW
Speed stages	Continuously variable
Saw band speeds	20 - 100 m/min
Saw band dimensions	2 720 x 27 x 0.9 mm
Dimensions (L x W x H)	2 305 x 2 260 x 1 780 mm
Table height material feed	800 mm
Weight	770 kg
min. remaining workpiece length	120 + 20 mm

Clamping range				
mm	0°	45°	60°	$\begin{matrix} b \\ a \times b \end{matrix}$
	230	180	100	X
	150*	110*	80*	X
	280 x 210	180 x 150	100 x 70	280 x 130

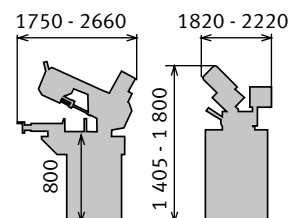

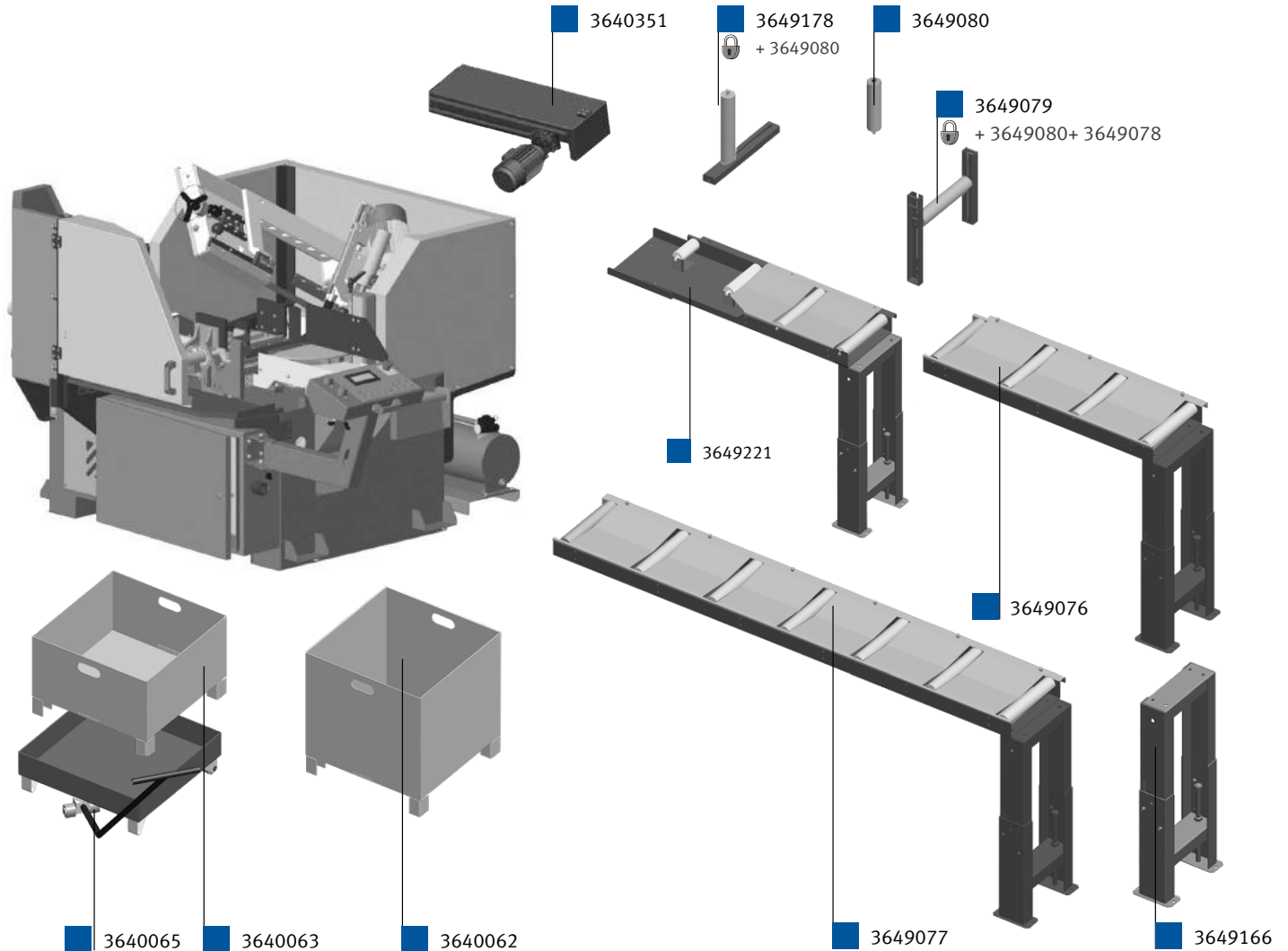
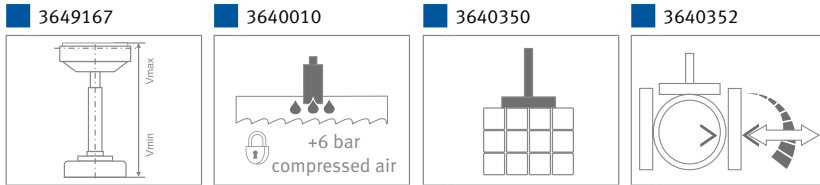

Optional accessories (only available from factory)

	Art. no.
Micro-spraying system	3640010
Hydraulic bundle clamping unit	3640350
Chip conveyor	3640351
Pressure regulator on vice	3640352

Accessories

Workpiece container	3640062
Swarf container	3640063
Trolley for swarf container and workpiece container	3640065

Roller conveyor width 290 mm

1 000 x 290 mm, roller conveyor 200 kg/m	3649076
2 000 x 290 mm, roller conveyor 200 kg/m	3649077
Connecting roller conveyor 1 000 x 290 mm discharge side	3649221

Accessories, roller conveyors 290 mm

lateral Steering roll 200 mm, mobile (requires: 3649080*)	3649078
lateral Guide roller 200 mm, rigid	3649080
Horizontal bundle clamping roller 290 mm (requires: 3649080* + 3649078*)	3649079
Additional leg for increasing the load bearing capacity	3649166
Roller support, height-adjustable, width 290 mm, load-bearing capacity 200 kg	3649167

Saw bands

2 720 x 27 x 0.9 mm 5-8 TPI M42 Sprint	3655508
2 720 x 27 x 0.9 mm 6-10 TPI M42 Sprint	3655510
2 720 x 27 x 0.9 mm 10-14 TPI M42 Sprint	3655514
2 720 x 27 x 0.9 mm 2-3 TPI M42 Sprint Plus	3655603
2 720 x 27 x 0.9 mm 3-4 TPI M42 Sprint Plus	3655604
2 720 x 27 x 0.9 mm 4-6 TPI M42 Sprint-Medium-VS	3655606
2 720 x 27 x 0.9 mm 2-3 TPI M51 Sprint Plus	3655703
2 720 x 27 x 0.9 mm 3-4 TPI M51 Sprint Plus	3655704
2 720 x 27 x 0.9 mm 4-6 TPI M51 Sprint Plus	3655706
2 720 x 27 x 0.9 mm 3-4 TPI X-FIT (PU=5)	3655805
2 720 x 27 x 0.9 mm 4-6 TPI X-FIT (PU=5)	3655806

* must be ordered with your order!

More saw bands and info on Page 283

When ordering a roller conveyor, always state whether you need a feed or discharge conveyor

BMBS 250 x 315 H-DG / BMBS 250 x 315 HA-DG

Hydraulic swivel frame metal-cutting band saw for mitre cuts from +60° to -45°, HA version fully-hydraulic with semi-automatic mode of operation

- ▶ For sawing, e.g., stainless steel, tool steel, hollow sections and full materials
- ▶ Precise and sturdy band guides with adjustable tungsten carbide plates
- ▶ When the saw arm lifts, the solenoid valve locks the lowering cylinder in top position, thus removing the need for additional locking on the cylinder
- ▶ Saw band tension monitoring - electro-mechanically via micro-switches
- ▶ with cooling system on the saw band guides
- ▶ with swarf clearing brush for optimum cleaning and maintenance of the saw band
- ▶ Saw arm tilted by 25° for a longer saw band service life
- ▶ Saw arm lowering manually or through deadweight (H-DG)
- ▶ After completing the cutting action, the saw band automatically stops
- ▶ After starting the cutting cycle, the vice automatically clamps - after completing the action, it returns to its original position (HA-DG)

Manual

Semi-automatic

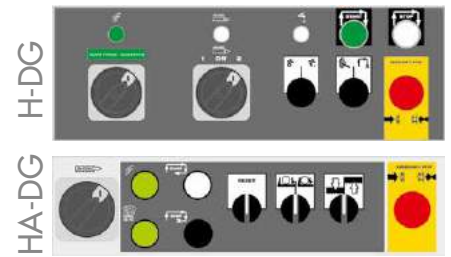

! For an exhaustive explanation of the controls, see pages 227 – 231



BMBS 250 x 315 H-DG



BMBS 250 x 315 HA-DG

Scope of delivery:

- › Saw band
- › Operating tool
- › Cross-cut fence 1 metre
- › Chip brush
- › Coolant pump

! We are always happy to perform sample cutting for your material. Call us for details!

Model	BMBS 250 x 315 H-DG	BMBS 250 x 315 HA-DG
Art. no.	3680007	3690093

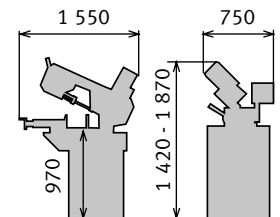

Technical specifications	BMBS 250 x 315 H-DG	BMBS 250 x 315 HA-DG
Motor output 3 x 400 V/50 Hz	0.75-1.1 kW	0.75-1.1 kW
Speed stages	2	2
Saw band speeds	37 / 74 m/min	37 / 74 m/min
Saw band dimensions	2 825 x 27 x 0.9 mm	2 825 x 27 x 0.9 mm
Dimensions (L x W x H)	1 550 x 750 x 1 870 mm	1 550 x 750 x 1 870 mm
Table height material feed	970 mm	970 mm
Weight	380 kg	420 kg
min. remaining workpiece length	14 mm	14 mm



Clamping ranges BMBS 250 x 315 H-DG / 250 x 315 HA-DG

mm	0°	45°	60°	45°	a ^b
	250	190	120	170	-
	150*	110*	80*	110*	-
	290 x 200	190 x 140	120 x 140	200 x 70	200 x 120

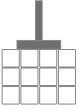
* recommended values

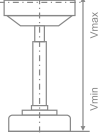
 3640104	 3640077	 3640010	 3649167	<table border="1"> <tr> <th>S (mm)</th> <th>Vmin (mm)</th> <th>Vmax (mm)</th> </tr> <tr> <td>290</td> <td>760</td> <td>980</td> </tr> </table>	S (mm)	Vmin (mm)	Vmax (mm)	290	760	980
S (mm)	Vmin (mm)	Vmax (mm)								
290	760	980								

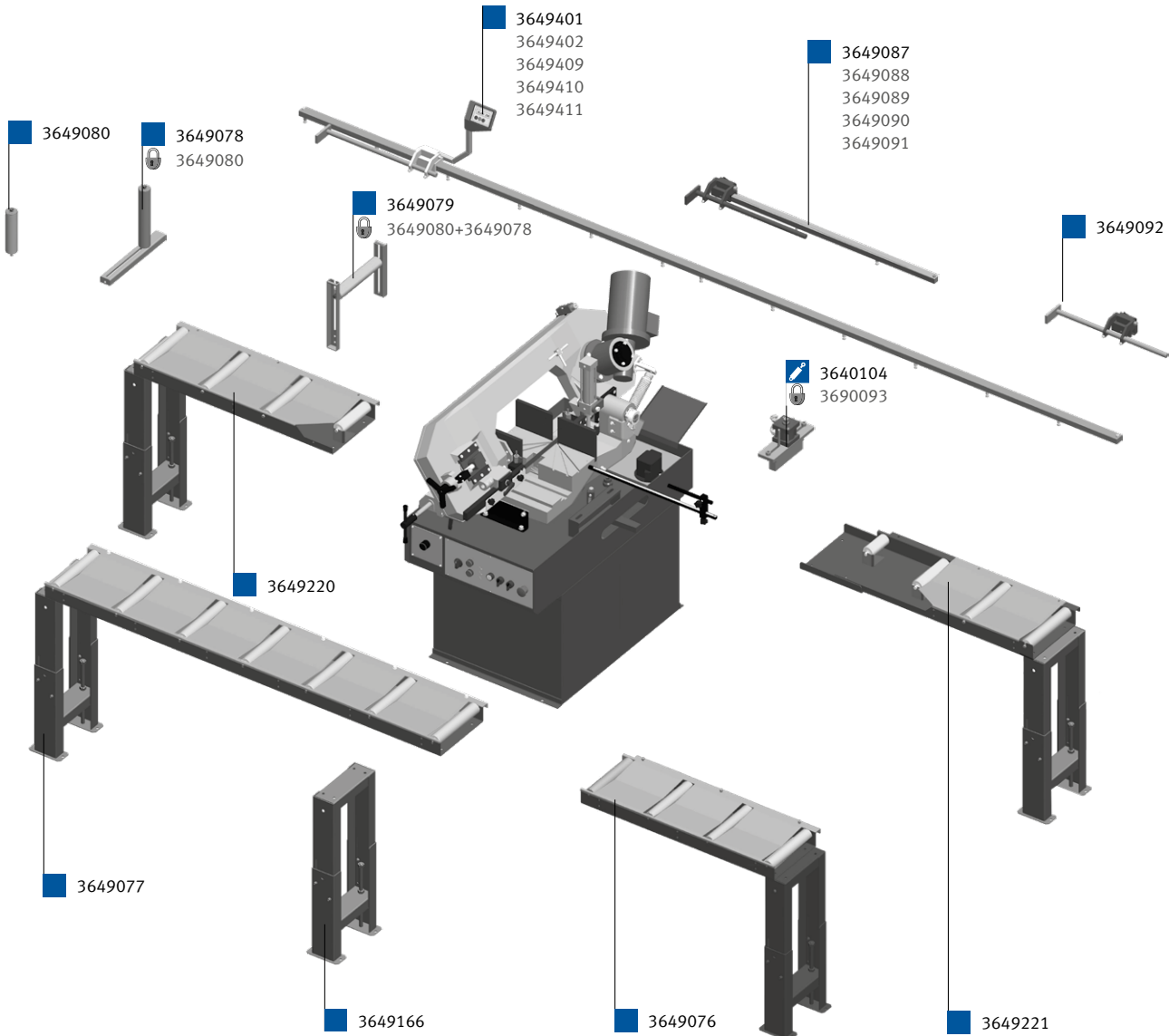

Optional accessories (only available from factory)	Art. no.	Accessories, roller conveyors 290 mm	Art. no.
Micro-spraying system	3640010	Additional leg for increasing the load bearing capacity	3649166
Motor + gearbox for cutting stainless steel (23/46 m/min.)	3640077	Roller support, height-adjustable, width 290 mm, load-bearing capacity 200 kg	3649167
Hydraul. Bundle clamping unit (for HA-DG only)	3640104	1 m folding stop with measuring scale	3649087
Accessories		2 m folding stop with measuring scale	3649088
Workpiece container	3640062	3 m folding stop with measuring scale	3649089
Swarf container	3640063	4 m folding stop with measuring scale	3649090
Trolley for swarf container and workpiece container	3640065	5 m folding stop with measuring scale	3649091
Roller conveyors 290 mm (incl. legs)		additional stop	3649092
1 000 x 290 mm, roller conveyor 200 kg/m	3649076	1 m stop with digital measuring display	3649401
2 000 x 290 mm, roller conveyor 200 kg/m	3649077	2 m stop with digital measuring display	3649402
1 000 x 290 mm connecting roller conveyor feed side	3649220	3 m stop with digital measuring display	3649409
1 000 x 290 mm connecting roller conveyor discharge side	3649221	4 m stop with digital measuring display	3649410
5 m stop with digital measuring display		5 m stop with digital measuring display	3649411
Accessories, roller conveyors 290 mm		M42 saw bands	
Lateral guide roller, moving (requires: 3649080*)	3649078	2 825 x 27 x 0.9 mm 3-4 TPI Sprint Plus	3655220
Lateral guide roller, rigid	3649080	2 825 x 27 x 0.9 mm 2-3 TPI Sprint Plus	3655221
Horizontal bundle clamping roller 290 mm (requires: 3649080* + 3649078*)	3649079	2 825 x 27 x 0.9 mm 4-6 TPI Sprint-Medium-VS	3655219
		2 825 x 27 x 0.9 mm 5-8 TPI Sprint	3655222
		2 825 x 27 x 0.9 mm 10-14 TPI Sprint	3655223
		2 825 x 27 x 0.9 mm 3-4 TPI X-FIT (PU=5)	3655810
		2 825 x 27 x 0.9 mm 4-6 TPI X-FIT (PU=5)	3655811

More saw bands and info on Page 283

When ordering a roller conveyor, always state whether you need a feed or discharge conveyor

* must be ordered with your order!

Magnetic drilling
Deburring
Metal grinding
Cutting
Notching & punching
Bending
Presses
Circular saws
Roller conveyors
Metal-cutting band saws

BMBS 300 x 320 H-DG

Hydraulic swivel frame metal-cutting band saw for mitre cuts from +60° to -45°.

Manual

- ▶ For sawing, e.g., stainless steel, tool steel, hollow sections and full materials
- ▶ With hydraulically controlled sawing functions
- ▶ Saw arm tilted by 25° for a longer saw band service life
- ▶ Saw band drive with low-maintenance, oil-lubricated worm gear
- ▶ With rugged 3-phase motor
- ▶ Motor includes overload protection
- ▶ Ball-bearing borne turntable
- ▶ With swarf clearing brush for optimum cleaning and maintenance of the saw band
- ▶ Saw arm tilted by 25° for a longer saw band service life
- ▶ Swivelling saw arm from +60° to -45°
- ▶ With swarf clearing brush for optimum cleaning and maintenance of the saw band
- ▶ Vice with manual material clamping unit and quick release unit for lateral adjustment of the vice

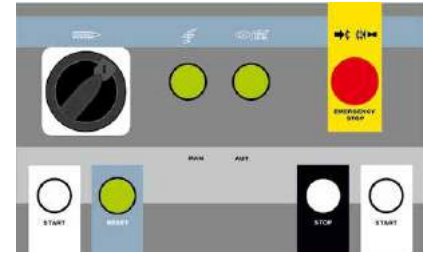

! For an exhaustive explanation of the controls, see pages 227 – 231

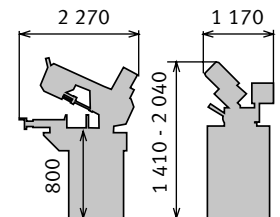

We are always happy to perform sample cutting for your material. Call us for details!





Scope of delivery:

- › Saw band
- › Operating tool
- › Cross-cut fence 1 metre
- › Swarf clearing brush
- › Swivelling control panel
- › Coolant pump

Model	BMBS 300 x 320 H-DG
Art. no.	3680012

Technical specifications	
Motor output 3 x 400 V/50 Hz	1.4-2.0 kW
Speed stages	2
Saw band speeds	35 / 70 m/min
Saw band dimensions	3 660 x 27 x 0.9 mm
Dimensions (L x W x H)	2 270 x 1 170 x 2 040 mm
Table height material feed	800 mm
Weight	548 kg
min. remaining workpiece length	30 mm

Clamping ranges

mm	0°	45°	60°	45°	 a ^b
	300	300	200	280	-
	180*	110*	80*	110*	-
	320 x 300	305 x 250	200 x 200	260 x 200	230 x 160

* recommended values

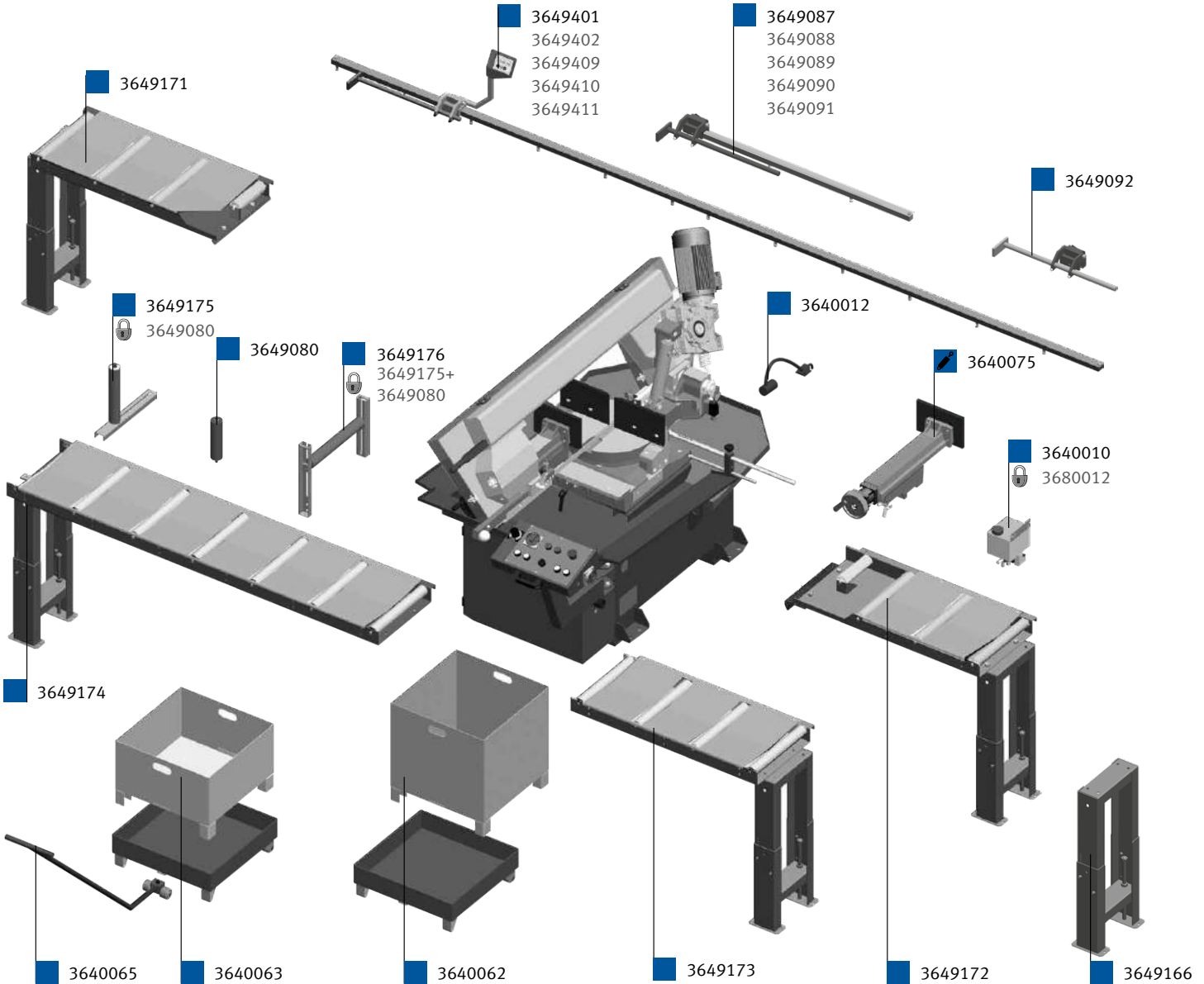
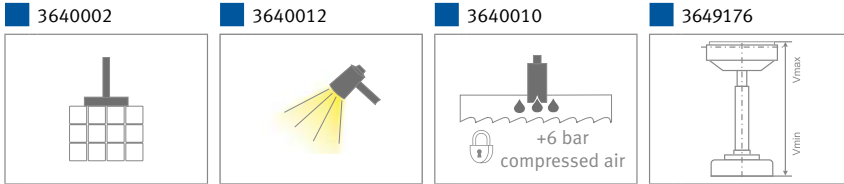

Optional accessories (only available from factory)	Art. no.
Workplace lighting	3640012
Micro-spraying system	3640010
Manual bundle clamping unit	3640002
Vice downstream of cut	3640075
Accessories	
Workpiece container	3640062
Swarf container	3640063
Trolley for swarf container and workpiece container	3640065
Roller conveyors 390 mm	
Connecting roller conveyor 390 mm feed side, f. 60° cuts between saw and roller conveyor, 200 kg/m	3649171
Connecting roller conveyor 390 mm discharge side, f. 60° cuts between saw and roller conveyor, 200 kg/m	3649172
1 000 x 390 mm, roller conveyor 200 kg/m	3649173
2 000 x 390 mm, roller conveyor 200 kg/m	3649174
M42 saw bands	
3 660 x 27 x 0.9 mm 3-4 TPI X-FIT (PU=5)	3655815
3 660 x 27 x 0.9 mm 4-6 TPI X-FIT (PU=5)	3655816

Accessories, roller conveyors 390 mm	Art. no.
lateral Steering roll 200 mm, mobile (requires: 3649080*)	3649175
lateral Guide roller 200 mm, rigid	3649080
Horizontal bundle clamping roller 390 mm (requires: 3649080 + 3649175)	3649176
Additional leg for increasing the load bearing capacity	3649166
Roller support, height-adjustable, width 390 mm, load-bearing capacity 200 kg	3649177
1 m folding stop with measuring scale	3649087
2 m folding stop with measuring scale	3649088
3 m folding stop with measuring scale	3649089
4 m folding stop with measuring scale	3649090
5 m folding stop with measuring scale	3649091
1 m stop with digital measuring display	3649401
2 m stop with digital measuring display	3649402
3 m stop with digital measuring display	3649409
4 m stop with digital measuring display	3649410
5 m stop with digital measuring display	3649411
additional stop	3649092

* must be ordered with your order!

More saw bands and info on Page 283

When ordering a roller conveyor, always state whether you need a feed or discharge conveyor

Magnetic drilling
Deburring
Metal grinding
Cutting
Notching & punching
Bending
Presses
Circular saws
Roller conveyors
Metal-cutting band saws

BMBS 300 x 320 HA-DG

Semi-automatic swivel frame metal-cutting band saw for mitre cuts of +60° up to -45° with frequency converter

Automatic

Semi-automatic

- ▶ For sawing, e.g., stainless steel, tool steel, hollow sections and full materials
- ▶ With hydraulically controlled sawing functions
- ▶ Saw arm tilted by 25° for a longer saw band service life
- ▶ Saw band drive with low-maintenance, oil-lubricated worm gear
- ▶ With rugged 3-phase motor
- ▶ Motor includes overload protection
- ▶ Ball-bearing borne turntable
- ▶ With swarf clearing brush for optimum cleaning and maintenance of the saw band
- ▶ BRP - saw band monitoring
- ▶ Continuously variable band speed (**HA-DG**)
- ▶ Hydraulic vice with manual quick release for lateral adjustment
- ▶ End switches control the upper and lower end positions of the saw arm
- ▶ With cut probe

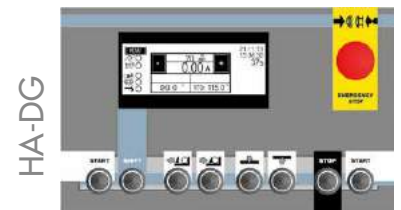

! For an exhaustive explanation of the controls, see pages 227 – 231

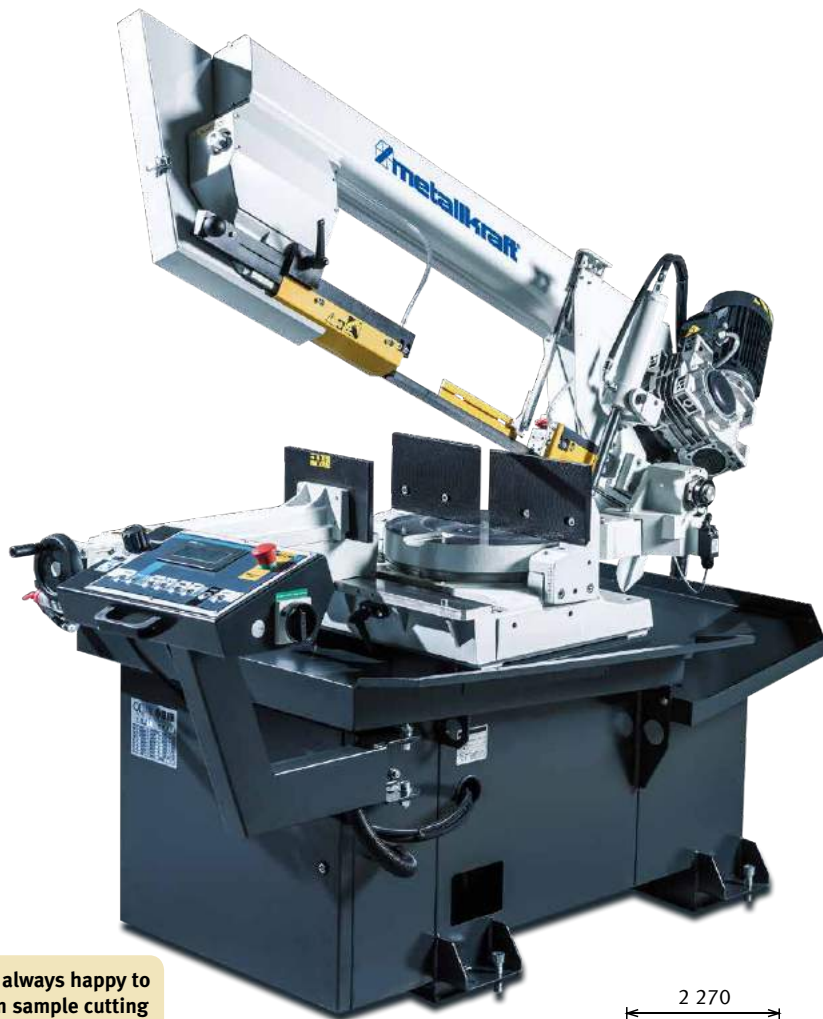

BMBS 300 x 320 HA-DG

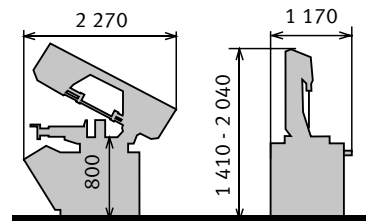

Info & video

Scope of delivery:

- > Saw band
- > Operating tool
- > Cross-cut fence 1 metre
- > Cut probe
- > Swivelling control panel
- > Coolant pump

We are always happy to perform sample cutting for your material. Call us for details!

Model	BMBS 300 x 320 HA-DG
Art. no.	3690041

Technical specifications	
Motor output 3 x 400 V/50 Hz	2.4 kW
Speed stages	Continuously variable
Saw band speeds	20-100 m/min
Saw band dimensions	3 660 x 27 x 0.9 mm
Dimensions (L x W x H)	2 270 x 1 170 x 2 040 mm
Table height material feed	800 mm
Weight	585 kg
min. remaining workpiece length	30 mm

Clamping ranges

mm	0°	45°	60°	45°	^b
	300	300	200	240	X
	180 *	110 *	80 *	110 *	X
	320 x 300	300 x 250	200 x 200	260 x 200	230 x 120

* recommended values

^a Bundle cutting with clamping device ^b max. bundle cut _{a x b}

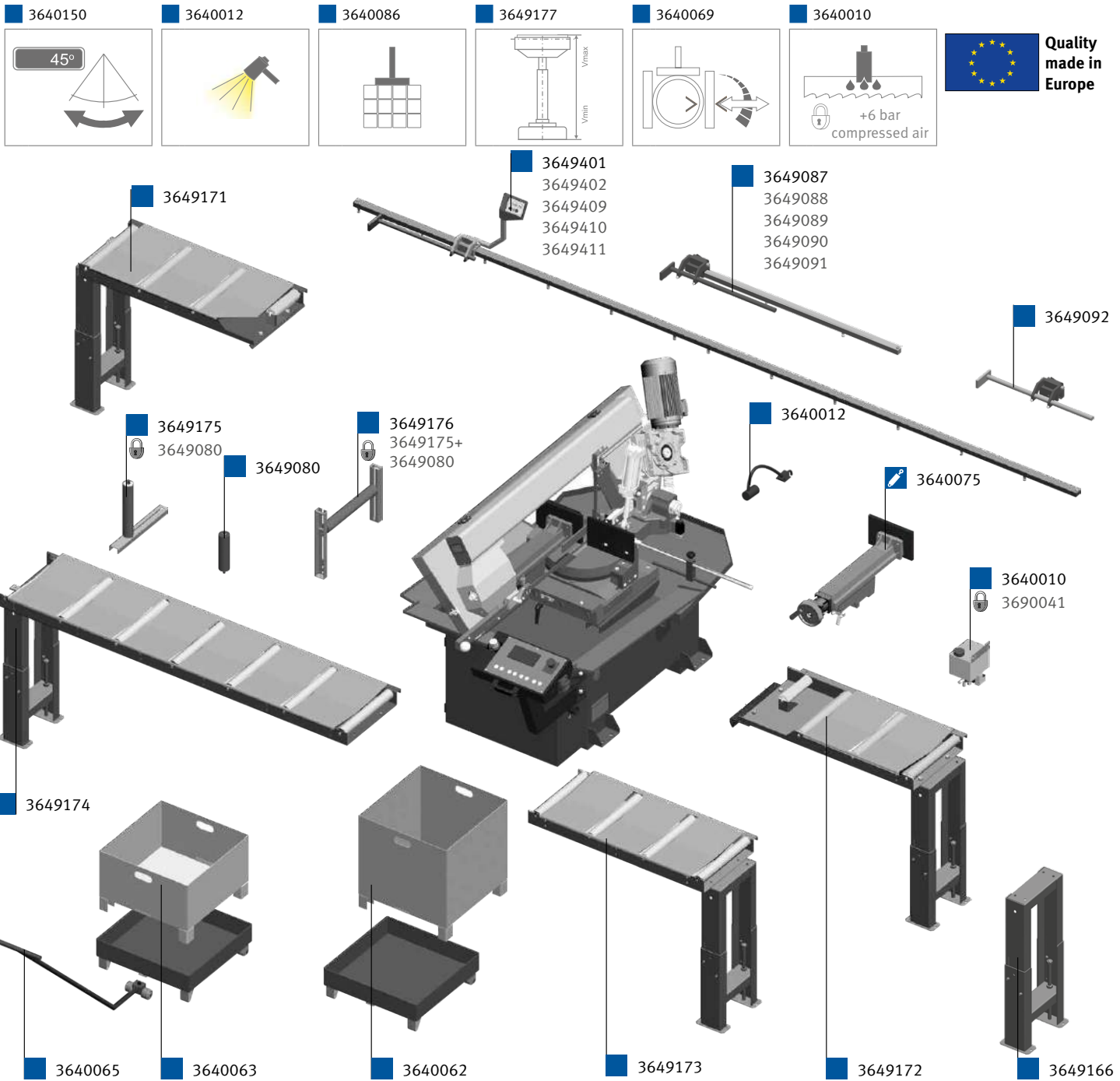

Optional accessories (only available from factory)	Art. no.
Workplace lighting	3640012
Micro-spraying system	3640010
Pressure regulator on vice	3640069
Hydraulic bundle clamping unit for HA	3640086
Digital angle display on saw arm model 3690041	3640150
Vice downstream of cut with hydraulic material clamping	3640107
Accessories	
Workpiece container	3640062
Swarf container	3640063
Trolley for swarf container and workpiece container	3640065
Coolant concentrate 5 l	3601751
Spraying agent 5 l, micro-dosing unit	3608020
Roller conveyors 390 mm	
Connecting roller conveyor 390 mm feed side, f. 60° cuts between saw and roller conveyor, 200 kg/m	3649171
Connecting roller conveyor 390 mm discharge side, f. 60° cuts between saw and roller conveyor, 200 kg/m	3649172
1 000 x 390 mm, roller conveyor 200 kg/m	3649173
2 000 x 390 mm, roller conveyor 200 kg/m	3649174

M42 saw bands	Art. no.
3 660 x 27 x 0.9 mm 3-4 TPI X-FIT (PU=5)	3655815
3 660 x 27 x 0.9 mm 4-6 TPI X-FIT (PU=5)	3655816
Accessories, roller conveyors 390 mm	Art. no.
lateral Guide roller 200 mm, moving (requires 3649080)	3649175
lateral Guide roller 200 mm, rigid	3649080
Horizontal bundle clamping roller 390 mm (requires: 3649080 + 3649175)	3649176
Additional leg for increasing the load bearing capacity	3649166
Roller support, height-adjustable, width 390 mm, load-bearing capacity 200 kg	3649177
1 m folding stop with measuring scale	3649087
2 m folding stop with measuring scale	3649088
3 m folding stop with measuring scale	3649089
4 m folding stop with measuring scale	3649090
5 m folding stop with measuring scale	3649091
1 m stop with digital measuring display	3649401
2 m stop with digital measuring display	3649402
3 m stop with digital measuring display	3649409
4 m stop with digital measuring display	3649410
5 m stop with digital measuring display	3649411
additional stop	3649092

* must be ordered with your order!

Magnetic drilling
Deburring
Metal grinding
Cutting
Notching & punching
Bending
Presses
Circular saws
Roller conveyors
Metal-cutting band saws

BMBS 300 x 320 CNC-G

Fully-automatic CNC-controlled swivel frame metal-cutting band saw for mitre cuts of up to +60°

Automatic

- ▶ Hydraulically controlled system for both vises, and the saw arm's up and down motion
- ▶ Material feed via ball screw
- ▶ Includes frequency converter as standard for continuously variable adjustment of the saw band speed from 20 - 100 m/min.
- ▶ BRP - saw band monitoring
- ▶ The jaws on the two vises are equipped with long stroke hydraulic cylinders as standard; this removes the need to preset to the material cross-section to be cut
- ▶ With pivoting cutting gap for mitre adjustment
-> thus avoiding cutting the saw table



! For an exhaustive explanation of the controls, see pages 227 – 231



Info & video



Scope of delivery:

- › Saw band
- › Operating tool
- › Digital angle display
- › Cut probe
- › Chip brush
- › Swivelling control panel
- › With band tension monitoring
- › Long stroke cylinder on both vises
- › Frequency converter,
- › Coolant pump

Model	BMBS 300 x 320 CNC-G
Art. no.	3690055

Technical specifications	
Motor output 3 x 400 V/50 Hz	2.4 kW
Speed stages	Continuously variable
Saw band speeds	20-100 m/min
Saw band dimensions	3 660 x 27 x 0.9 mm
Dimensions (L x W x H)	2 310 x 2 710 x 2 050 mm
Table height material feed	800 mm
Weight	800 kg
Minimum size of material	20 mm
Remaining piece length	115+20 mm

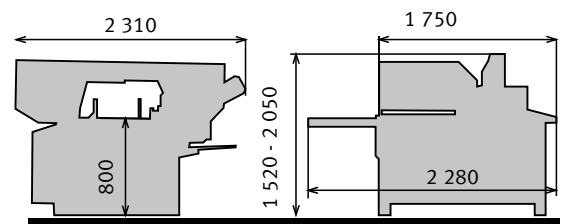

Clamping ranges

mm	0°	45°	60°	a x b
	300	300	200	X
	180 *	110 *	80 *	X
	320 x 300	300 x 250	200 x 200	230 x 120

! We are always happy to perform sample cutting for your material. Call us for details!

* recommended values

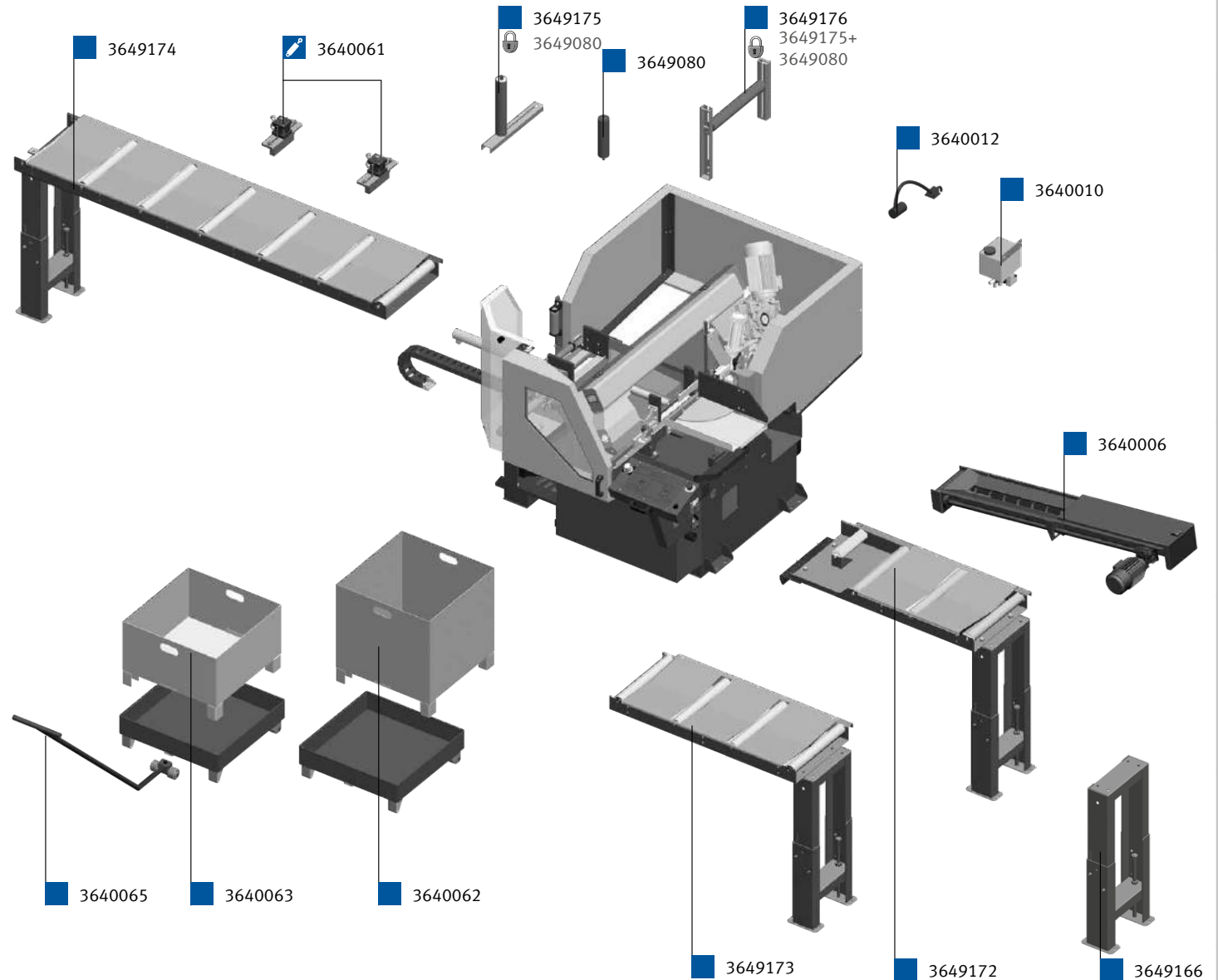
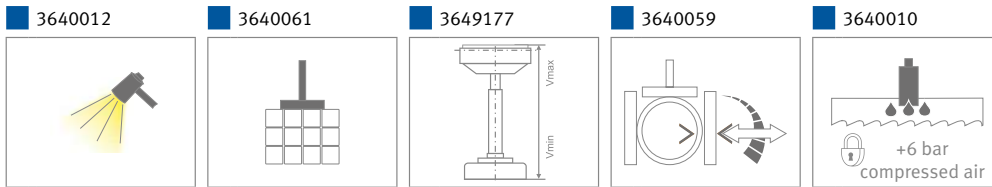

Optional accessories (only available from factory)	Art. no.
Workplace lighting	3640012
Micro-spraying system	3640010
Pressure regulator on vice	3640059
Hydr. bundle clamping unit	3640061
Chip conveyor incl. swarf container	3640006
Accessories	
Coolant concentrate 5 l	3601751
Spraying agent 5 l, micro-dosing unit	3608020
Workpiece container	3640062
Swarf container	3640063
Trolley for swarf container and workpiece container	3640065

Roller conveyors 390 mm	Art. no.
Connecting roller conveyor 390 mm discharge side, f. 60° cuts between saw and roller conveyor, 200 kg/m	3649172
1 000 x 390 mm, roller conveyor 200 kg/m	3649173
2 000 x 390 mm, roller conveyor 200 kg/m	3649174
Accessories, roller conveyors 390 mm	
lateral Guide roller 200 mm, moving (requires 3649080)	3649175
lateral Guide roller 200 mm, rigid	3649080
Horizontal bundle clamping roller 390 mm (requires: 3649080 + 3649175)	3649176
Additional leg for increasing the load bearing capacity	3649166
Roller support, height-adjustable, width 390 mm, load-bearing capacity 200 kg	3649177
M42 saw bands	
3 660 x 27 x 0.9 mm 3-4 TPI X-FIT (PU=5)	3655815
3 660 x 27 x 0.9 mm 4-6 TPI X-FIT (PU=5)	3655816
* must be ordered with your order!	

More saw bands and info on Page 283

! When ordering a roller conveyor, always state whether you need a feed or discharge conveyor

Magnetic drilling
Deburring
Metal grinding
Cutting
Notching & punching
Bending
Presses
Circular saws
Roller conveyors
Metal-cutting band saws

BMBS 360 x 500 HA-DG

Semi-automatic swivel frame metal-cutting band saw for mitre cuts of +60° up to -60° with frequency converter

Semi-automatic

- ▶ designed for industrial use
- ▶ For sawing, e.g., stainless steel, tool steel, hollow sections and full materials
- ▶ Saw band drive with low-maintenance, oil-lubricated worm gear
- ▶ With rugged 3-phase motor including overload protection
- ▶ Saw band guide with adjustable tungsten carbide plates
- ▶ With mechanical saw band tensioning, and monitoring via micro-switch
- ▶ Cooling system on the saw band guides
- ▶ Includes frequency converter for continuously variable adjustment of the saw band speed from 20 – 100 m/min.
- ▶ With BRP saw band monitoring as standard

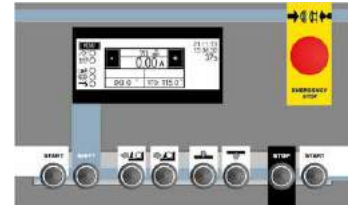

! For an exhaustive explanation of the controls, see pages 227 – 231



We are always happy to perform sample cutting for your material. Call us for details!

Scope of delivery:

- > Saw band
- > Operating tool
- > Swarf clearing brush
- > Coolant pump
- > Digital angle display (HA-DG only)

Model	BMBS 360 x 500 HA-DG
Art. no.	3690090

Technical specifications	
Motor output 3 x 400 V/50 Hz	3.0 kW
Speed stages	Continuously variable
Saw band speeds	20-100 m/min
Saw band dimensions	4 780 x 34 x 1.1 mm
Dimensions (L x W x H)	2 900 x 950 x 2 270 mm
Table height material feed	820 mm
Weight	715 kg
min. remaining workpiece length	35 mm

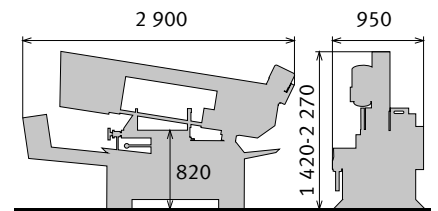

Clamping ranges

mm	0°	45°	60°	45°	60°	a ^b
	360	360	300	360	300	X
	250 *	180 *	130 *	180 *	130 *	X
	500 x 340	440 x 220	310 x 220	430 x 220	300 x 220	500 x 220

* recommended values

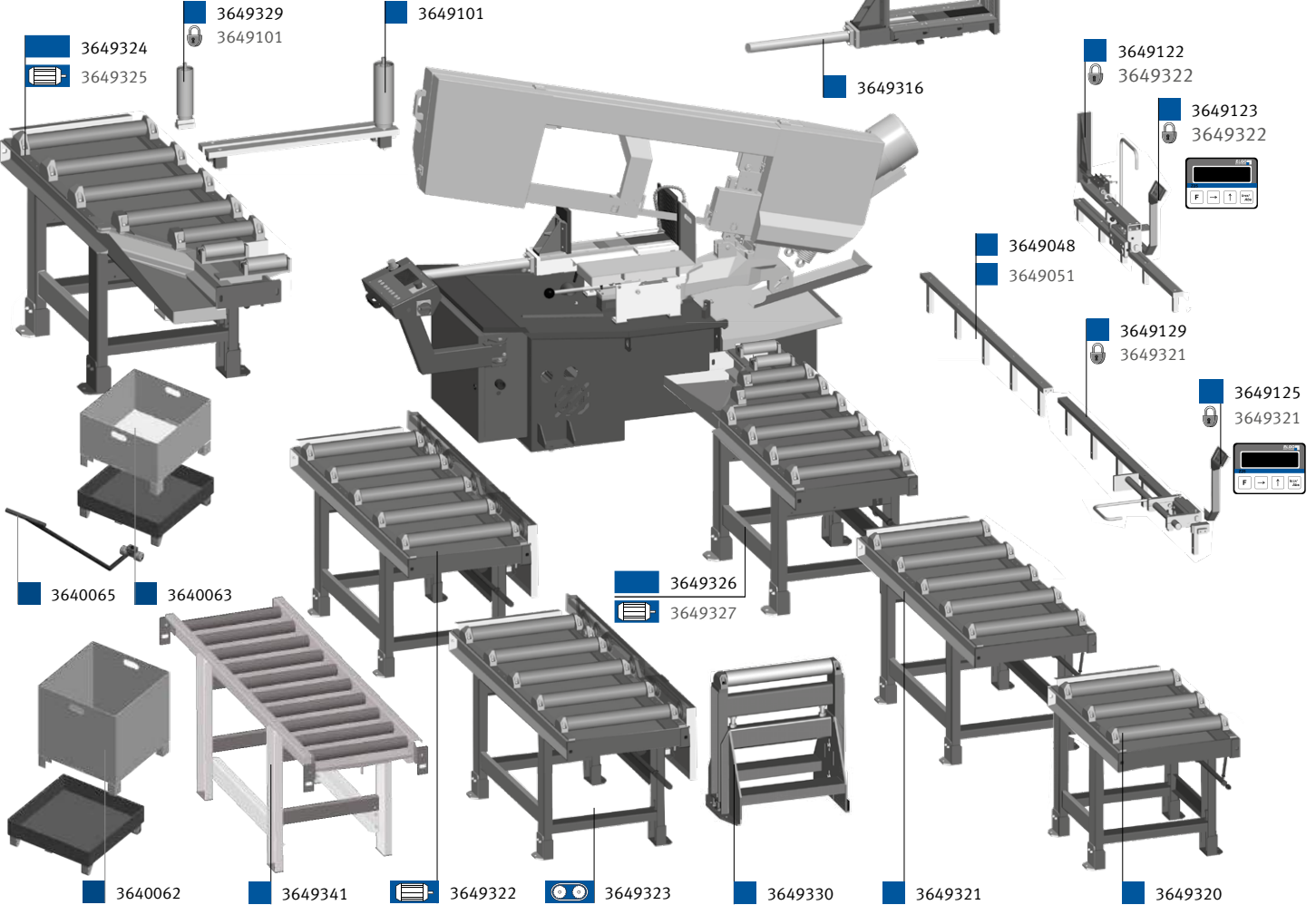
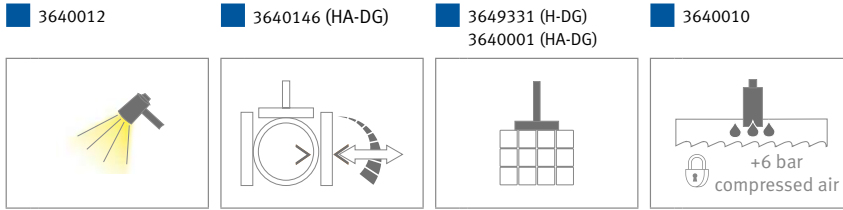

Optional accessories (only available from factory)	Art. no.
Micro-spraying system	3640010
Workplace lighting	3640012
Pressure regulator on vice	3640146
Vice downstream of cut	3649316
Hydraulic bundle clamping unit	3640001
Optional accessories (only available from factory)	Art. no.
Workpiece container	3640062
Swarf container	3640063
Trolley for swarf container and workpiece container	3640065
Roller conveyors 520 mm	Art. no.
Roller conveyor 1 000 x 520 mm	3649320
Roller conveyor 2 000 x 520 mm	3649321
Motorised roller conveyor 2 000 x 520 mm	3649322
Extension to motorised roller conveyor 2 000 x 520 mm	3649323
Feed roller conveyor for 60° cuts, motorised 2 000 x 520 mm	3649325
Discharge roller conveyor for 60° cuts 2 000 x 520 mm	3649326
Discharge roller conveyor for 60° cuts, motorised 2 000 x 520 mm	3649327
Roller conveyor lightweight type 250 kg/m	Art. no.
Roller conveyor 2 000 x 520 mm (6 rollers)	3649340
Roller conveyor 2 000 x 520 mm (10 rollers)	3649341

Roller conveyor heavy-duty type 1 000 kg/m	Art. no.
lateral guide roller, moving for roller conveyors (requires: 3649328)	3649329
Lateral guide roller, rigid	3649328
height-adjustable roller 700 kg/m	3649330
Additional roller 520 mm (requires: 3649320 + 3649321)	3649311
2 m stop fixed with measuring scale	3649129
2 m stop with digital measuring display	3649125
Electro-mechanical stop for motor. Roller conveyor with scale (requires: 3649322)	3649122
Electro-mechanical stop for motor. Roller conveyor/digital display (requires: 3649322)	3649123
2 m extension for stop with measuring device	3649048
2 m extension for stop with digital display	3649051
M42 saw bands	Art. no.
4 780 x 34 x 1.1 mm 2-3 TPI Sprint Plus	3655400
4 780 x 34 x 1.1 mm 3-4 TPI Sprint Plus	3655401
4 780 x 34 x 1.1 mm 4-6 TPI Sprint-Medium-VS	3655402
4 780 x 34 x 1.1 mm 5-8 TPI Sprint	3655403
4 780 x 34 x 1.1 mm 3-4 TPI X-FIT (PU=5)	3655825
4 780 x 34 x 1.1 mm 4-6 TPI X-FIT (PU=5)	3655826

* must be ordered with your order!

More saw bands and info on Page 283

When ordering a roller conveyor, always state whether you need a feed or discharge conveyor

Magnetic drilling
Deburring
Metal grinding
Cutting
Notching & punching
Bending
Presses
Circular saws
Roller conveyors
Metal-cutting band saws

Automatic pivot frame metal-cutting band saw for mitre cuts from 0° to +60° right

Automatic

- ▶ For sawing, e.g., stainless steel, tool steel, hollow sections and full materials
- ▶ Precise and sturdy band guides with adjustable tungsten carbide plates
- ▶ Hydraulically controlled system for both vises, and the saw arm's up and down motion
- ▶ Material feed via ball screw
- ▶ With swarf clearing brush for optimum cleaning and maintenance of the saw band
- ▶ Includes frequency converter as standard for continuously variable adjustment of the saw band speed from 20 - 100 m/min.
- ▶ BRP - saw band monitoring
- ▶ The jaws on the material clamps are equipped with long stroke hydraulic cylinders as standard; this removes the need to adjust the setup for the material cross-section to be cut



! For an exhaustive explanation of the controls, see pages 227 – 231



We are always happy to perform sample cutting for your material. Call us for details!

- Scope of delivery:**
- › Saw band
 - › Front/rear safety perimeter
 - › Vice with quick release
 - › Continuously variable adjustment of the saw band speed
 - › Workplace lighting
 - › Automatic band guide setting
 - › Driven swarf clearing brush
 - › Hydraulic band tensioning unit
 - › Operating tool

BMBS 360 x 500 CNC-G

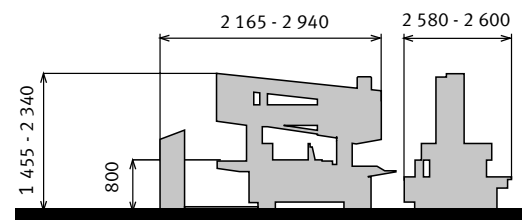

Model	BMBS 360 x 500 CNC-G
Art. no.	3690092
Technical specifications	
Motor output 3 x 400 V/50 Hz	3.0 kW
Speed stages	Continuously variable
Saw band speeds	20 - 100 m/min
Saw band dimensions	4 780 x 34 x 1.1 mm
Dimensions (L x W x H)	2 940 x 2 600 x 2 340 mm
Table height material feed	800 mm
Weight	1 500 kg
min. remaining workpiece length	120 + 20 mm

Clamping ranges

mm	0°	45°	60°	a x b
	360	360	300	X
	250*	180*	130*	X
	500 x 340	440 x 220	310 x 220	500 x 220

* recommended values

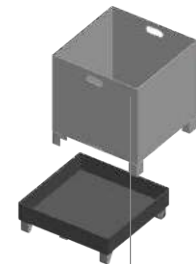
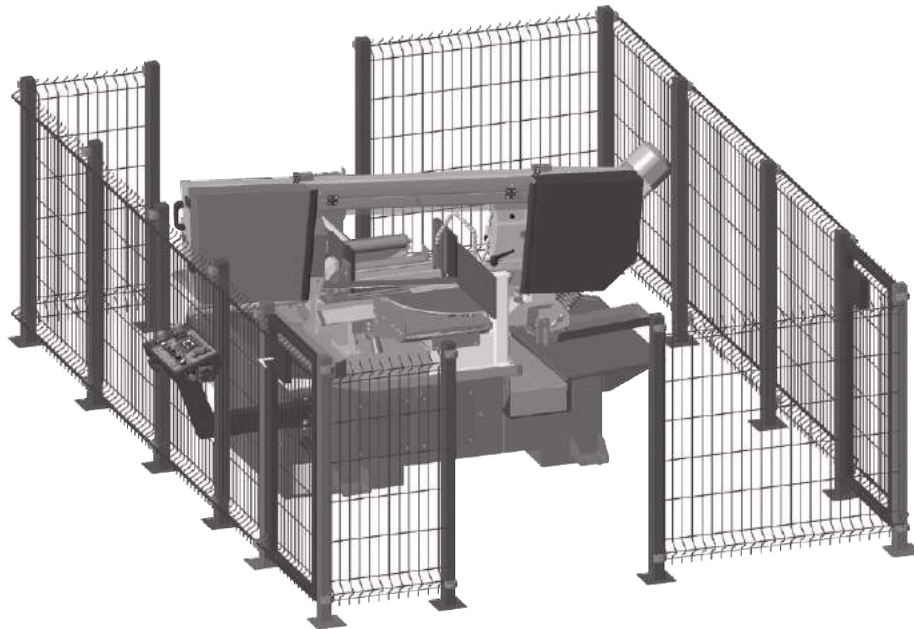
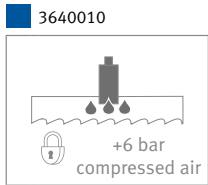

3640062

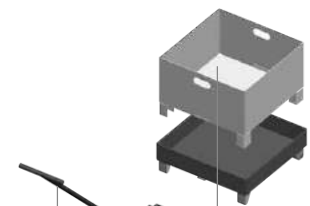

3640065

3640063



3649311



3649321



3640006



3649341



3649320



3649330



3649329

3649328

Optional accessories (only available from factory)	Art. no.	Accessories for roller conveyor heavy-duty type	Art. no.
Hydraulic bundle clamping unit	3640360	lateral Guide roller, rigid	3649328
Micro-spraying system	3640010	lateral Adjustable guide roller (requires 3649328*)	3649329
Workplace lighting	3640012	Roller support 520 mm, height-adjustable	
Chip conveyor	3640006	max. load-bearing capacity 700 kg	3649330
Pressure regulator on vice	3640362	Additional roller 520 mm	
Accessories		(requires 3649320 and 3649321*)	3649311
Workpiece container	3640062	M42 saw bands	
Swarf container	3640063	4 780 x 34 x 1.1 mm 2-3 TPI Sprint Plus	3655400
Trolley for swarf container and workpiece container	3640065	4 780 x 34 x 1.1 mm 3-4 TPI Sprint Plus	3655401
Roller conveyor lightweight type 250 kg/m		4 780 x 34 x 1.1 mm 4-6 TPI Sprint-Medium-VS	3655402
Roller conveyor 2 000 x 800 mm (6 rollers)	3649340	4 780 x 34 x 1.1 mm 5-8 TPI Sprint	3655403
Roller conveyor 2 000 x 800 mm (6 rollers)	3649341	4 780 x 34 x 1.1 mm 3-4 TPI X-FIT (PU=5)	3655825
Roller conveyor heavy-duty type 1 000 kg/m		4 780 x 34 x 1.1 mm 4-6 TPI X-FIT (PU=5)	3655826
1 000 x 520 mm roller conveyor	3649320	* must be ordered with your order!	
2 000 x 520 mm roller conveyor	3649321		
2000 x 520 mm discharge roller conveyor for 60° cuts	3649326		

More saw bands and info on page 283

When ordering a roller conveyor, always state whether you need a feed or discharge conveyor

BMBS 460 x 600 HA-DG

Semi-automatic swivel frame metal-cutting band saw for mitre cuts of +60° up to -60° with frequency converter

Semi-automatic

- ▶ For sawing, e.g., stainless steel, tool steel, hollow sections and full materials
- ▶ With completely hydraulically controlled sawing functions
- ▶ Saw band drive with low-maintenance, oil-lubricated worm gear
- ▶ With rugged 3-phase motor including overload protection
- ▶ Saw band guide with adjustable tungsten carbide plates
- ▶ With swarf clearing brush for optimum cleaning and maintenance of the saw band
- ▶ Cooling system on the saw band guides
- ▶ The vice is equipped with a long stroke hydraulic cylinder as standard; this removes the need to preset to the material cross-section to be cut
- ▶ The clamping jaws can move throughout the entire clamping area
- ▶ BRP - saw band monitoring
- ▶ With frequency converter for continuously variable adjustment of the saw band speed from 20 - 100 m/min.
- ▶ With STOP function - the sawing action can be interrupted at any time by pressing a switch. The band continues to run while the arm moves out of the cutting channel

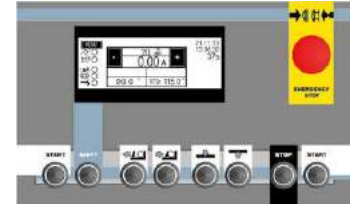

! For an exhaustive explanation of the controls, see pages 227 – 231



We are always happy to perform sample cutting for your material. Call us for details!

Scope of delivery:

- > Saw band
- > Operating tool
- > Digital angle display
- > Coolant pump

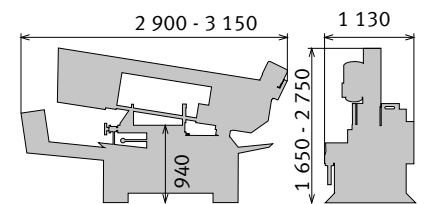

Model	BMBS 460 x 600 HA-DG
Art. no.	3690067

Technical specifications	
Motor output 3 x 400 V/50 Hz	4.0 kW
Speed stages	Continuously variable
Saw band speeds	20-100 m/min
Saw band dimensions	5 380 x 41 x 1.3 mm
Dimensions (L x W x H)	3 550 x 1 130 x 2 750 mm
Table height material feed	940 mm
Weight	1 270 kg

Clamping ranges BMBS 460 x 600 HA-DG

mm	0°	45°	60°	45°	60°	a ^b
	460	460	320	460	320	X
	400 *	280 *	200 *	280 *	190 *	X
	600 x 460	470 x 240	330 x 180	470 x 250	320 x 240	600 x 250

* recommended values

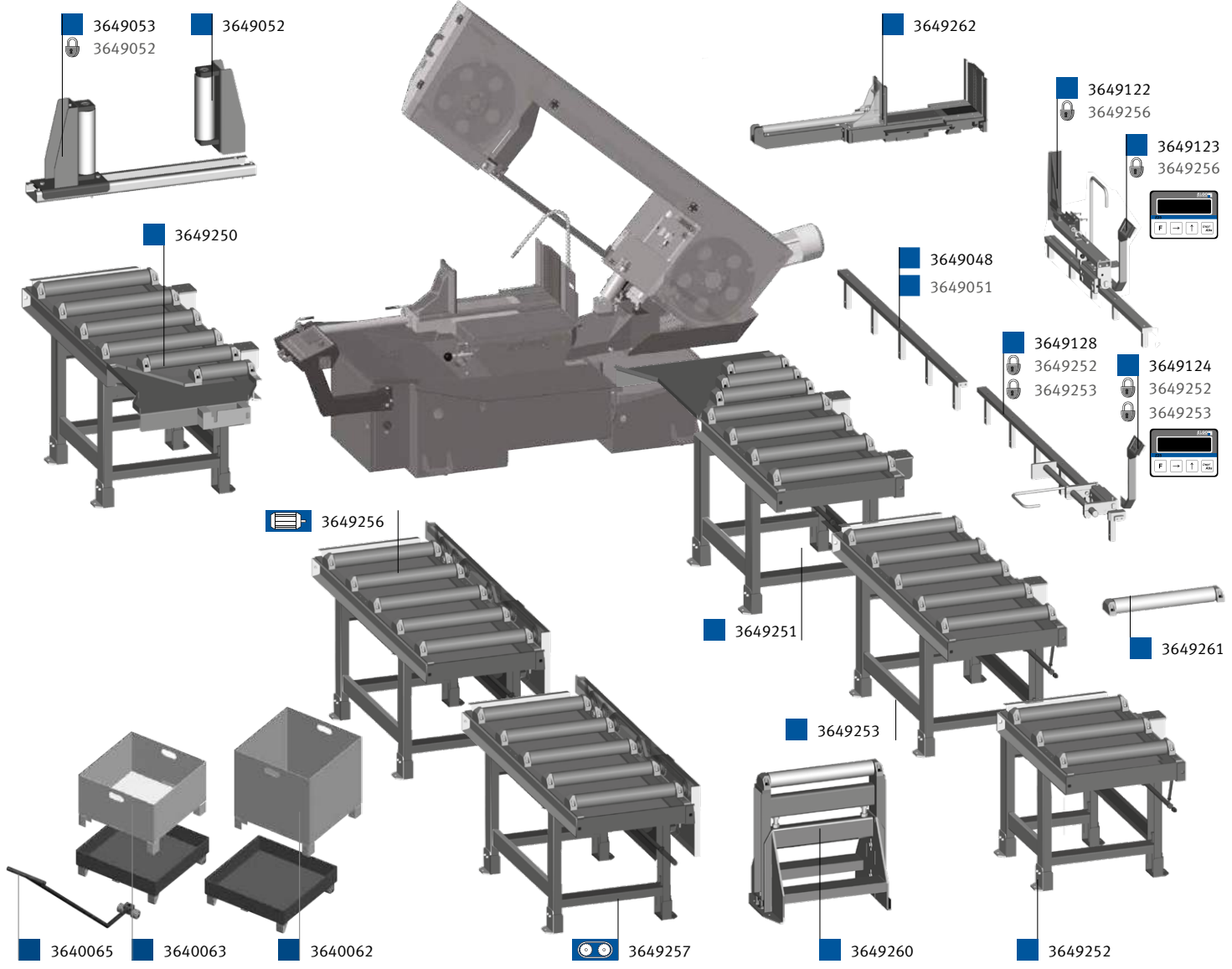
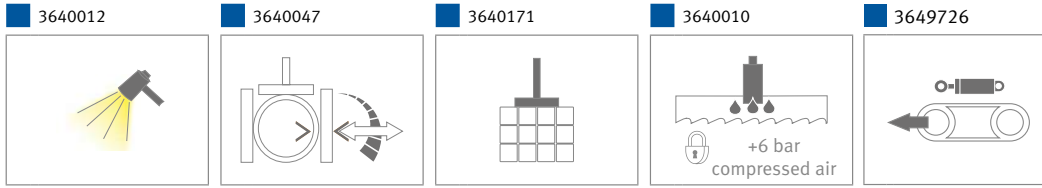

Optional accessories (only available from factory)

	Art. no.
Micro-spraying system	3640010
Hydraulic bundle clamping unit	3640171
Hydraul. band tensioning unit	3649726
Hydraulic vice downstream of cut	3649262
Workplace lighting	3640012
Pressure regulator on vice	3640047
Accessories	
Workpiece container	3640062
Swarf container	3640063
Trolley for swarf and workpiece container	3640065
Roller conveyors (incl. legs and connecting adapter) 600 mm	
Feed roller conveyor for 60° cuts between saw and roller conveyor including connection plate, 1 000 kg/m	3649250
Discharge roller conveyor for 60° cuts between saw and roller conveyor including connection plate, 1 000 kg/m	3649251
1 000 x 620 mm feed/discharge roller conveyor, 1 000 kg/m	3649252
2 000 x 620 mm feed/discharge roller conveyor, 1 000 kg/m	3649253
Roller conveyor heavy-duty type 1 700 kg/m	
Motorised roller conveyor 2 000 x 620 mm	3649256
2 000 x 620 mm roller conveyor extension motorised (requires 3649256)	3649257

	Art. no.
Roller conveyors lightweight type 350 kg/m	
Roller conveyor 2 000 x 620 mm (6 rollers)	3649355
Roller conveyor heavy-duty type 1 700 kg/m	
lateral guide roller, moving for roller conveyors (requires: 3649052*)	3649053
Lateral guide roller, rigid	3649052
Roller support, height-adjustable, width 600 mm, load-bearing capacity 700 kg	3649260
Additional roller 600 mm	3649261
2 m stop fixed with measuring scale	3649129
2 m stop with digital measuring display	3649125
Electro-mechanical stop for roller conveyor motorised with scale (requires 3649256)	3649122
Electro-mechanical stop for roller conveyor motorised with digital measuring display (requires 3649256)	3649123
2 m extension for stop with measuring device	3649048
2m extension for stop with digital measuring display	3649051
M42 saw bands	
5 400 x 41 x 1.3 mm 3-4 TPI Sprint Plus	3655230
5 400 x 41 x 1.3 mm 2-3 TPI Sprint Plus	3655231
5 400 x 41 x 1.3 mm 4-6 TPI Sprint Plus	3655232

* must be ordered with your order!

When ordering a roller conveyor, always state whether you need a feed or discharge conveyor

More saw bands and info on Page 283

Magnetic drilling
Deburring
Metal grinding
Cutting
Notching & punching
Bending
Presses
Circular saws
Roller conveyors
Metal-cutting band saws

HMBS 340 CNC-DG-X

Fully-automatic two-column horizontal metal-cutting band saw
with ARP system for for mitre cuts from +60° to -45° and 1 000 mm material feed length

Automatic

- ▶ designed for industrial use
- ▶ Extremely stable and robust structure
- ▶ Saw band drive with low-maintenance, oil-lubricated worm gear
- ▶ Including SIEMENS Simatic control and SIEMENS electrical system
- ▶ Ball screw controlled material and saw feed
- ▶ With rugged 3-phase motor
- ▶ Includes frequency converter for continuously variable adjustment of the saw band speed from 20 – 100 m/min.
- ▶ Motor includes overload protection
- ▶ Saw band guide with adjustable tungsten carbide plates
- ▶ A completely hydraulically-controlled system controls the machine clamping force work sequences
- ▶ With swivelling saw arm up to +60°



! For an exhaustive explanation of the controls, see pages 227 – 231

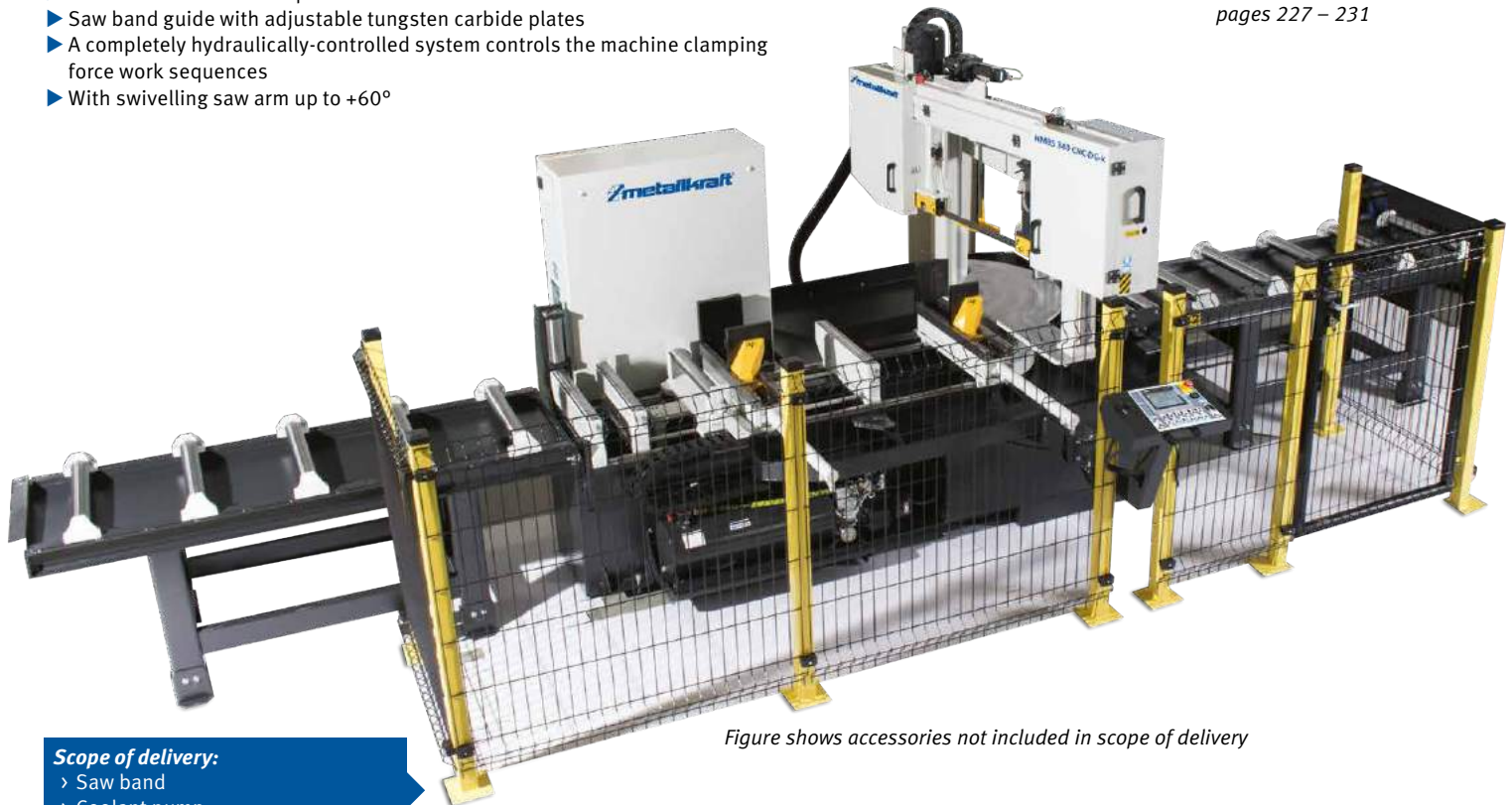

Figure shows accessories not included in scope of delivery

Scope of delivery:

- › Saw band
- › Coolant pump
- › Operating tool
- › Pressure regulator on vice
- › Continuously variable adjustment of the saw band speed
- › Driven swarf clearing brush
- › Chip conveyor for stainless steel incl. swarf container
- › 64-bit control system
- › Workplace lighting
- › Operating tool
- › Automatic material feed of 1 000 mm
- › Safety perimeter

We are always happy to perform sample cutting for your material. Call us for details!

Model	HMBS 340 CNC-DG-X
Art. no.	3691341
Technical specifications	
Motor output 3 x 400 V/50 Hz	3.0 kW
Speed stages	Continuously variable
Saw band speeds	20 - 100 m/min
Saw band dimensions	4 780 x 34 x 1.1 mm
Dimensions (L x W x H)	3 050 x 2 900 x 2 100 mm
Table height material feed	800 mm
Weight	2 150 kg
min. remaining workpiece length	310 mm

Clamping ranges HMBS 340 CNC-DG-X

mm	0°	45°	60°	45°
	350	350	230	350
	250	180*	130*	180*
	500 x 340	385x340	220 x 340	390 x 340
	340 x 340	340 x 340	340 x 220	340 x 340

* recommended values

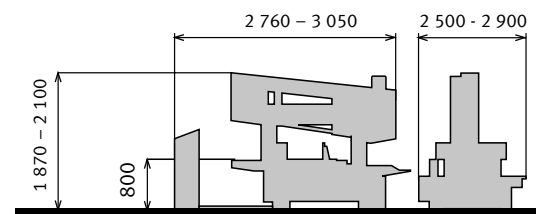

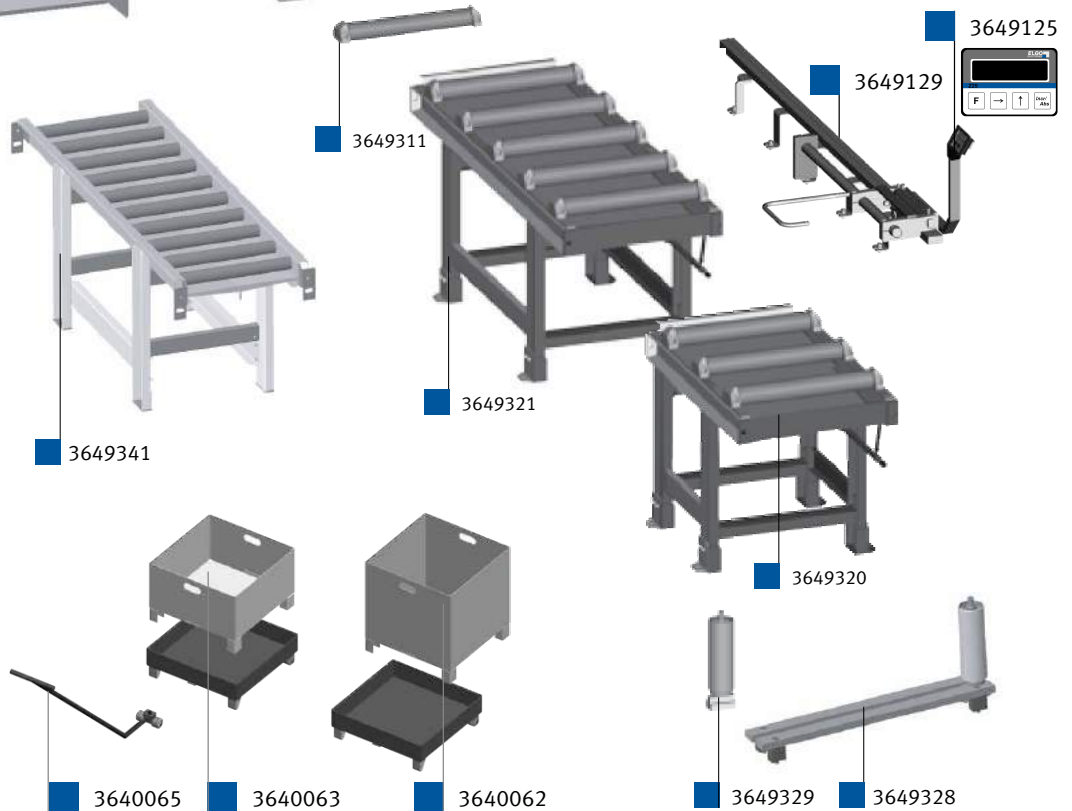
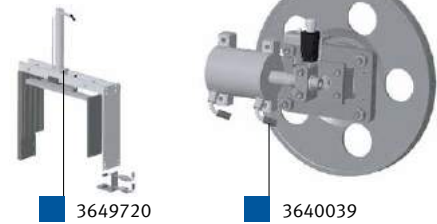
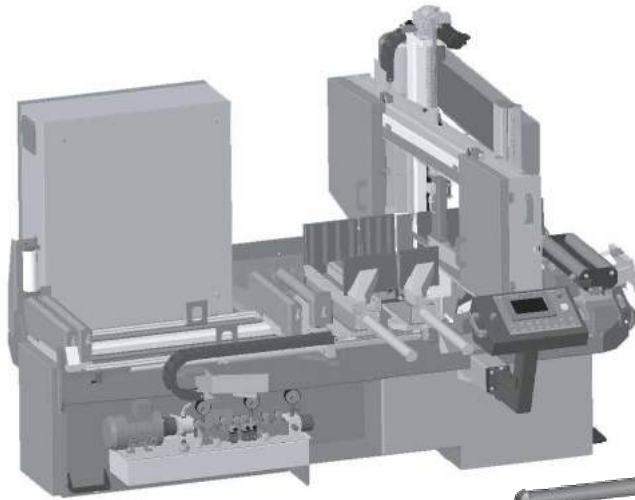
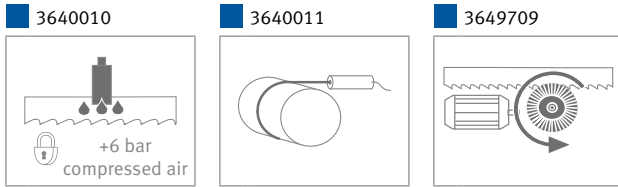

Optional accessories (only available from factory)	Art. no.
motorised swarf brush	3649709
Micro-spraying system	3640010
Cutting line laser	3640011
Accessories	
Workpiece container	3640062
Swarf container	3640063
Trolley for swarf container and workpiece container	3640065
Coolant concentrate 5 l	3601751
Spraying agent 5 l, micro-dosing unit	3608020
Roller conveyor lightweight type 250 kg/m	
Roller conveyor 2 000 x 520 mm (6 rollers)	3649340
Roller conveyor 2 000 x 520 mm (10 rollers)	3649341

Roller conveyor heavy-duty type 1 000 kg/m	Art. no.
Roller conveyor 1 000 x 520 mm	3649320
Roller conveyor 2 000 x 520 mm	3649321
Accessories for roller conveyor heavy-duty type	
Lateral guide roller	3649328
Lateral guide roller, adjustable	3649329
height-adjustable roller 700 kg/m	3649330
Additional roller 520 mm	3649311
2 m stop fixed with measuring scale	3649129
2 m stop with digital measuring display	3649125
M42 saw bands	
4 780 x 34 x 1.1 mm 2-3 TPI Sprint Plus	3655400
4 780 x 34 x 1.1 mm 3-4 TPI Sprint Plus	3655401
4 780 x 34 x 1.1 mm 4-6 TPI Sprint-Medium-VS	3655402
4 780 x 34 x 1.1 mm 5-8 TPI Sprint	3655403
4 780 x 34 x 1.1 mm 3-4 TPI X-FIT (PU=5)	3655825
4 780 x 34 x 1.1 mm 4-6 TPI X-FIT (PU=5)	3655826

* must be ordered with your order!

More saw bands and info on Page 283

When ordering a roller conveyor, always state whether you need a feed or discharge conveyor

HMBS 500 x 750 HA-DG/ HMBS 500 x 750 HA-DG X

Semi-automatic two column horizontal metal-cutting band saw for mitre cuts of +60° to -60°, designed for industrial use

Semi-automatic

- ▶ Semi-automatic, hydraulically controlled two-column guided steel design
- ▶ For cutting sections and full materials
- ▶ Bearings for adjusting the saw frame for angle cuts with smoothed guide surfaces on the machine body
- ▶ A hydraulically controlled system controls the machines work sequences
- ▶ Linear guides on both columns ensure perfect cutting results
- ▶ BRP - saw band monitoring (HA-DG)
- ▶ Front band guide automatically moves in parallel with the moving vice jaw
- ▶ HA-DG X with ARP system
- ▶ Saw band tilted by 7° for improved cutting performance and a longer service life
- ▶ With horizontally swivelling saw arm from +60° to -60°
- ▶ Continuously variable adjustment of the saw band speed from 20 - 100 m/min.
- ▶ Safety display for saw band tension and protective hood open
- ▶ Emulsion cooling with liquid distribution across the saw band guides in the cutting channel
- ▶ For straight cuts, clamping of the material upstream and downstream of the cut through two-part vice



! For an exhaustive explanation of the controls, see pages 227 – 231



driven cleaning brush for cleaning and maintenance of the saw band



Scope of delivery:

- › Saw band
- › Operating tool
- › Two rugged support rollers
- › Frequency converter,
- › Hydraulic angle adjustment
- › Swarf purging gun
- › Digital angle display
- › Coolant pump
- › Pressure regulator on vice

Scope of supply HA-DG X:

- › Workplace lighting

! We are always happy to perform sample cutting for your material. Call us for details!

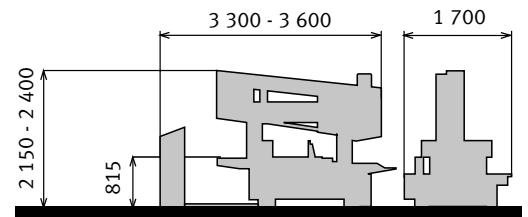

Model	HMBS 500 x 750 HA-DG	HMBS 500 x 750 HA-DG X
Art. no.	3690075	3690076
Technical specifications		
Motor output 3 x 400 V/50 Hz	4.0 kW	4.0 kW
Speed stages	Continuously variable	Continuously variable
Saw band speeds	20-100 m/min	20-100 m/min
Saw band dimensions	6 500 x 41 x 1.3 mm	6 500 x 41 x 1.3 mm
Dimensions (L x W x H)	3 600 x 1 700 x 2 400 mm	3 600 x 1 700 x 2 400 mm
Table height material feed	815 mm	815 mm
Weight	2 000 kg	2 000 kg

Clamping ranges HMBS 500 x 750

mm	0°	45°	60°	45°	60°	a b
	500	500	330	500	300	X
	400 *	280 *	200 *	280 *	190 *	X
	750x480	500x480	330x480	500x480	300x480	750x260

* recommended values

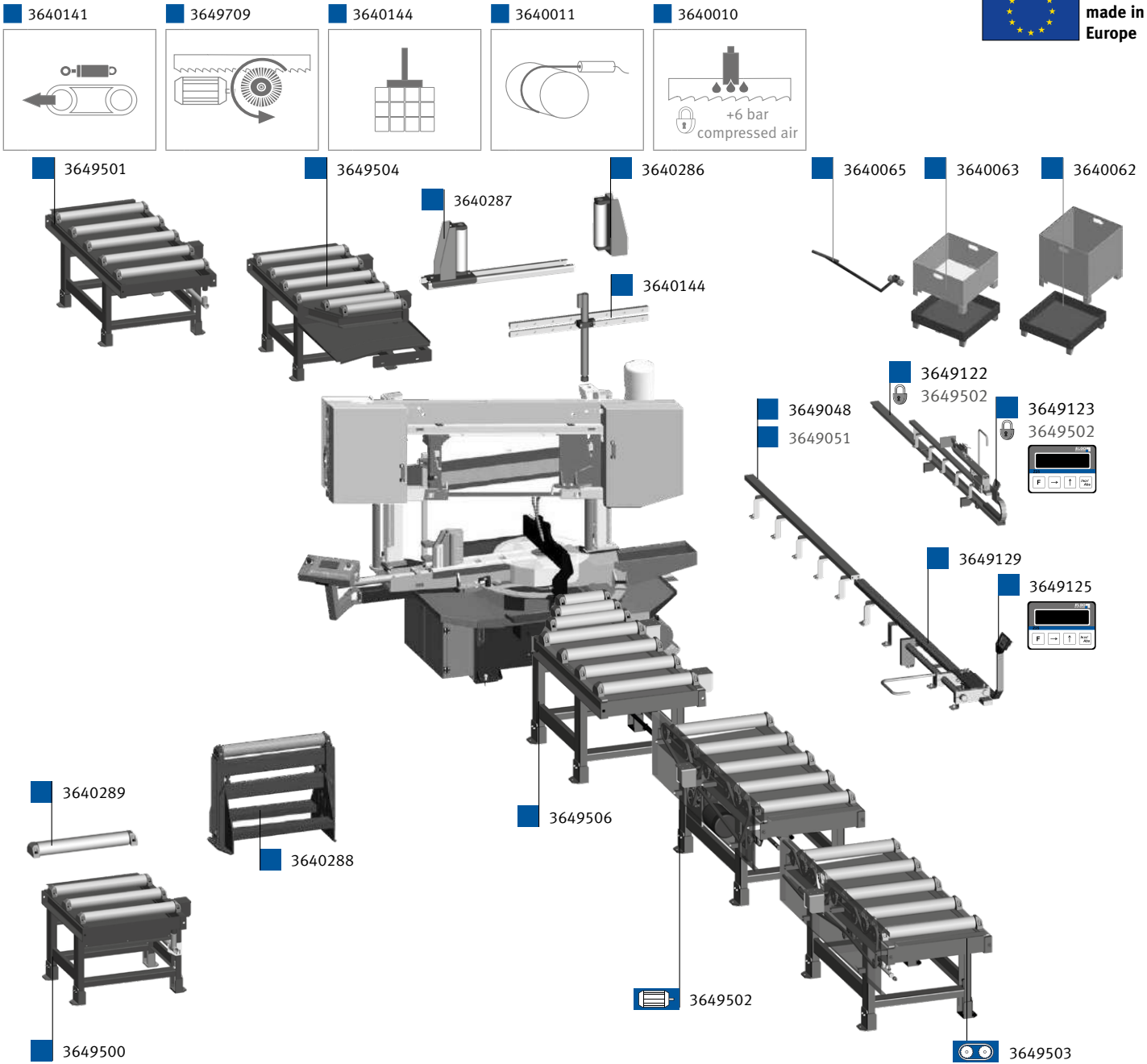

Optional accessories	Art. no.	Roller conveyors lightweight type 350 kg/m	Art. no.
Hydraul. Bundle clamping unit	3640144	Roller conveyor 2 000 x 620 mm (6 rollers)	3649360
Hydraul. band tensioning unit	3640141	Accessories, roller conveyors	
Micro-spraying system	3640010	lateral guide roller, moving	3640287
Cutting line laser	3640011	Lateral guide roller, rigid	3640286
motorised swarf brush	3649709	Roller support, height-adjustable, width 620 mm, load-bearing capacity 700 kg	3640288
Chip conveyor (HA-DG-X only)	3640142	Additional roller 1 000 mm (requires: 3649500/3649501*)	3640289
Accessories		2 m stop fixed with measuring scale	3649129
Workpiece container	3640062	2 m stop with digital measuring display	3649125
Swarf container	3640063	Electro-mechanical stop for motor. Roller conveyor with scale (requires: 3649502)	3649122
Trolley for swarf container and workpiece container	3640065	Electro-mechanical stop for motor. Roller conveyor with digital display (requires 3649502*)	3649123
Coolant concentrate 5 l	3601751	2 m extension for stop with measuring device	3649048
Spraying agent 5 l, micro-dosing unit	3608020	2 m extension for stop with digital display	3649051
Roller conveyors heavy-duty type 1 700 kg/m		M42 saw bands	
1 000 x 800 mm roller conveyor	3649500	6 500 x 41 x 1.3 mm 2-3 TPI Sprint Plus	3655240
2 000 x 800 mm roller conveyor	3649501	6 500 x 41 x 1.3 mm 3-4 TPI Sprint Plus	3655241
Motorised roller conveyor 2 000 x 800 mm	3649502	6 500 x 41 x 1.3 mm 5-8 TPI Sprint	3655242
2 000 x 800 mm motorised extension	3649503	* must be ordered with your order!	
1 000 x 800 mm feed roller conveyor	3649504		
1 000 x 800 mm discharge roller conveyor	3649506		

When ordering a roller conveyor, always state whether you need a feed or discharge conveyor

More saw bands and info on Page 283

Magnetic drilling
Deburring
Metal grinding
Cutting
Notching & punching
Bending
Presses
Circular saws
Roller conveyors
Metal-cutting band saws

Fully-automatic two-column horizontal metal-cutting band saw ARP system for for mitre cuts from +60° to -60° and 2 000 mm transporter

Automatic

- ▶ For cutting bar materials, including stainless steels and tool steels, both sections and solid materials
- ▶ Semi-automatic and automatic operation individually selectable
- ▶ For straight cuts, clamping of the material upstream and downstream of the cut through two-part vice
- ▶ With ARP system: Automatic control of the cutting feed speed as a function of the material cross section, or saw band tpi
- ▶ Saw band tilted by 7° for improved cutting performance and a longer service life
- ▶ The clamping jaw moves throughout the entire cutting area
- ▶ Hydraulically controlled angle adjustment of the saw frame
- ▶ Front band guide automatically moves in parallel with the moving vice jaw
- ▶ Cooling system on the saw band guides
- ▶ Continuously variable adjustment of the saw band speed from 20 - 100 m/min.



! For an exhaustive explanation of the controls, see pages 227 – 231



HMBS 500x750 NC-DG X BC 2 000

- Scope of delivery:**
- ▶ Saw band
 - ▶ Front/rear safety perimeter
 - ▶ Operating tool
 - ▶ With automatic transporter 2 000 mm as standard
 - ▶ Workplace lighting
 - ▶ Pressure regulator on vice
 - ▶ Continuously variable adjustment of the saw band speed
 - ▶ Driven swarf clearing brush
 - ▶ 64-bit control system
 - ▶ Workplace lighting
 - ▶ Coolant pump

We are always happy to perform sample cutting for your material. Call us for details!

Model	HMBS 500x750 NC-DG X BC 2 000
Art. no.	3690080
Technical specifications	
Motor output 3 x 400 V/50 Hz	5.5 kW
Speed stages	Continuously variable
Saw band speeds	20-100 m/min
Saw band dimensions	6 500 x 41 x 1.3 mm
Dimensions (L x W x H)	3 600 x 5 880 x 2 400 mm
Table height material feed	815 mm
Weight	4 150 kg
min. remaining workpiece length	30 mm

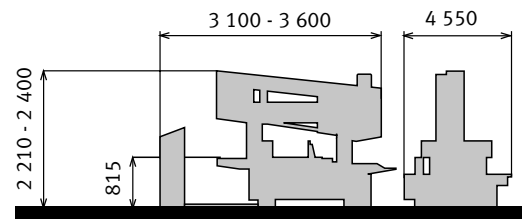

Clamping ranges HMBS 500 x 750 NC-DG X 2 000

mm	0°	45°	60°	45°	60°	a b
	500	500	330	500	300	X
	400 *	280 *	200 *	280 *	190 *	X
	750 x 480	500 x 480	330 x 480	500 x 480	300 x 480	750 x 450

* recommended values

New

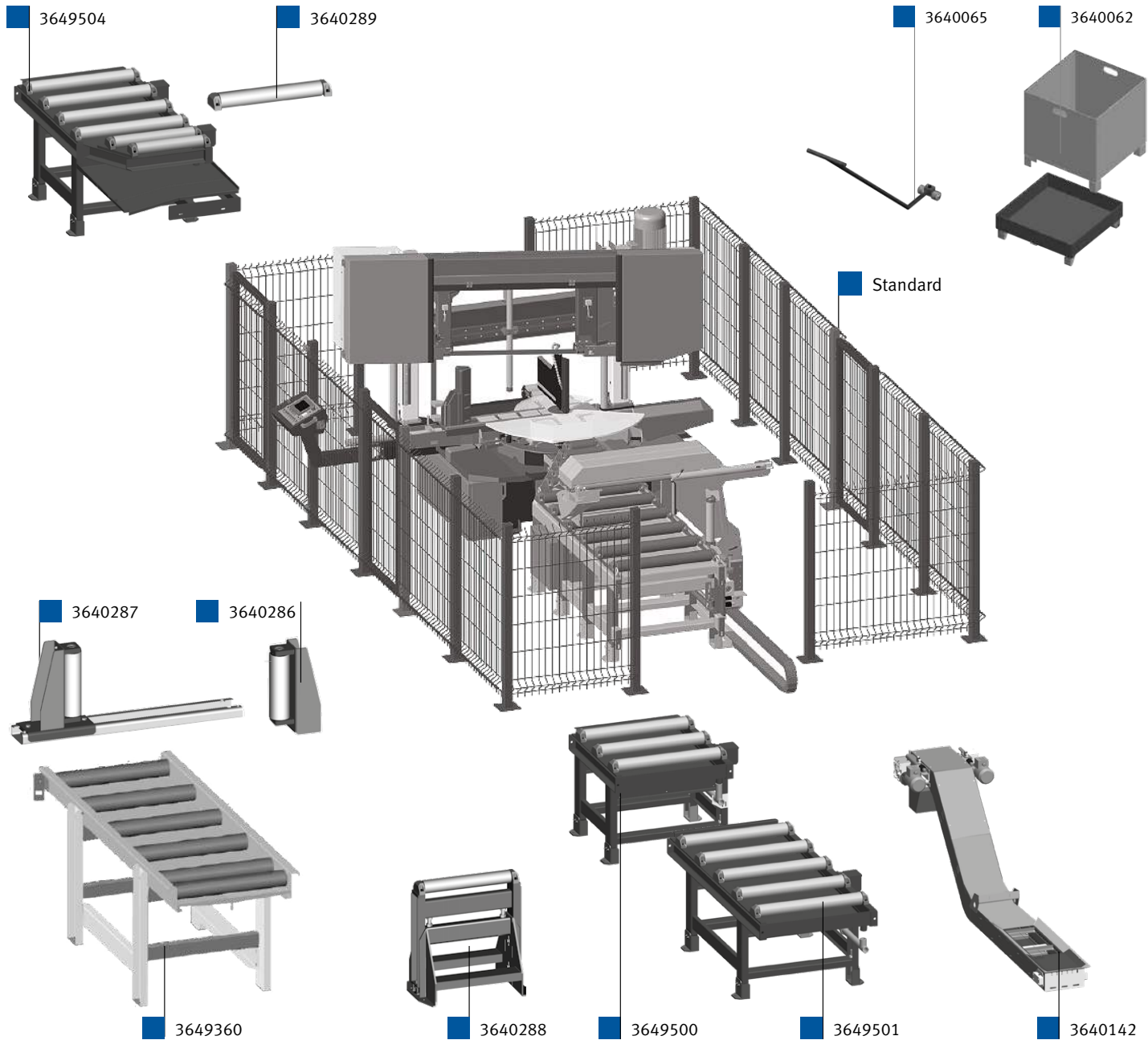
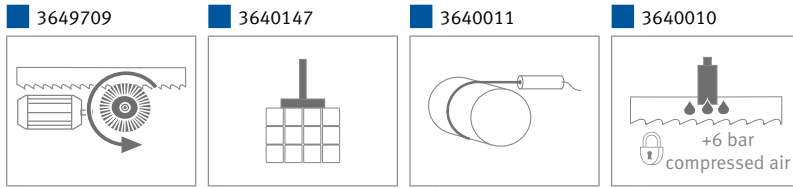

Optional accessories	Art. no.	Roller conveyors heavy-duty type 1 700 kg/m	Art. no.
Chip conveyor	3640142	1 000 x 800 mm roller conveyor	3649500
Hydraul. Bundle clamping unit	3640147	2 000 x 800 mm roller conveyor	3649501
Micro-spraying system	3640010	2 000 x 800 mm feed roller conveyor	3649504
Cutting line laser	3640011	Accessories, roller conveyors	Art. no.
Motorised swarf brush	3649709	lateral guide roller, moving for roller conveyors	3640287
Accessories		Lateral guide roller, rigid	3640286
Workpiece container	3640062	Roller support, height-adjustable, width 620 mm, load-bearing capacity 700 kg	3640288
Trolley for swarf container and workpiece container	3640065	Additional roller 620 mm	3640289
Roller conveyors lightweight type 350 kg/m		M42 saw bands	
Roller conveyor 2 000 x 620 mm (6 rollers)	3649360	6 500 x 41 x 1.3 mm 2-3 TPI Sprint Plus	3655240
		6 500 x 41 x 1.3 mm 3-4 TPI Sprint Plus	3655241
		6 500 x 41 x 1.3 mm 5-8 TPI Sprint	3655242

When ordering a roller conveyor, always state whether you need a feed or discharge conveyor

* must be ordered with your order!

More saw bands and info on Page 283

Magnetic drilling
Deburring
Metal grinding
Cutting
Notching & punching
Bending
Presses
Circular saws
Roller conveyors
Metal-cutting band saws

HMBS 300 x 300 CNC X

Fully-automatic two-column horizontal metal-cutting band saw with ARP system for heavy duty industrial use

Automatic

- ▶ For sawing, e.g., stainless steel, tool steel, sections and full materials
- ▶ Compact design with short distance between saw arm guide and vice for low-vibration operation
- ▶ Saw arm with stroke measuring sensor for determining the position above the workpiece and an additional bottom end position sensor
- ▶ Saw band guide with adjustable tungsten carbide plates
- ▶ Rugged saw band guide borne on linear guides
- ▶ Front band guide automatically moves in parallel with the moving vice for more stable saw band guiding
- ▶ Continuously variable adjustment of the saw band speed from 20 - 100 m/min.
- ▶ Hydraulically driven swarf brush



! For an exhaustive explanation of the controls, see pages 227 – 231



Info & video



Scope of delivery:

- › Full cladding
- › Saw band
- › Operating tool
- › Chip conveyor
- › Frequency converter,
- › Workplace lighting
- › Automatic band guide setting
- › Coolant pump
- › Cut probe
- › Hydraulic band tensioning unit
- › Pressure regulator on vice

We are always happy to perform sample cutting for your material. Call us for details!

Model	HMBS 300 x 300 CNC X
Art. no.	3690098
Technical specifications	
Motor output 3 x 400 V/50 Hz	3.0 kW
Speed stages	Continuously variable
Saw band speeds	20 - 100 m/min
Saw band dimensions	4 520 x 34 x 1.1 mm
Dimensions (L x W x H)	2 980 x 2 080 x 2 140 mm
Table height material feed	800 mm
Weight	1 420 kg
max. feed length for 1 x feed unit	505 mm
min. remaining workpiece length CNC operation	120 mm***

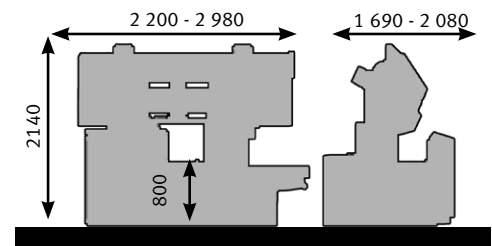

Clamping ranges HMBS 300 x 300

mm	0°	$\begin{matrix} b \\ a \times b \end{matrix}$
	300	X
	250 *	X
	300 x 300	300 x 220

* recommended values

*** Recommended minimum value. This value can change depending on the weight of surface of the material to be cut.

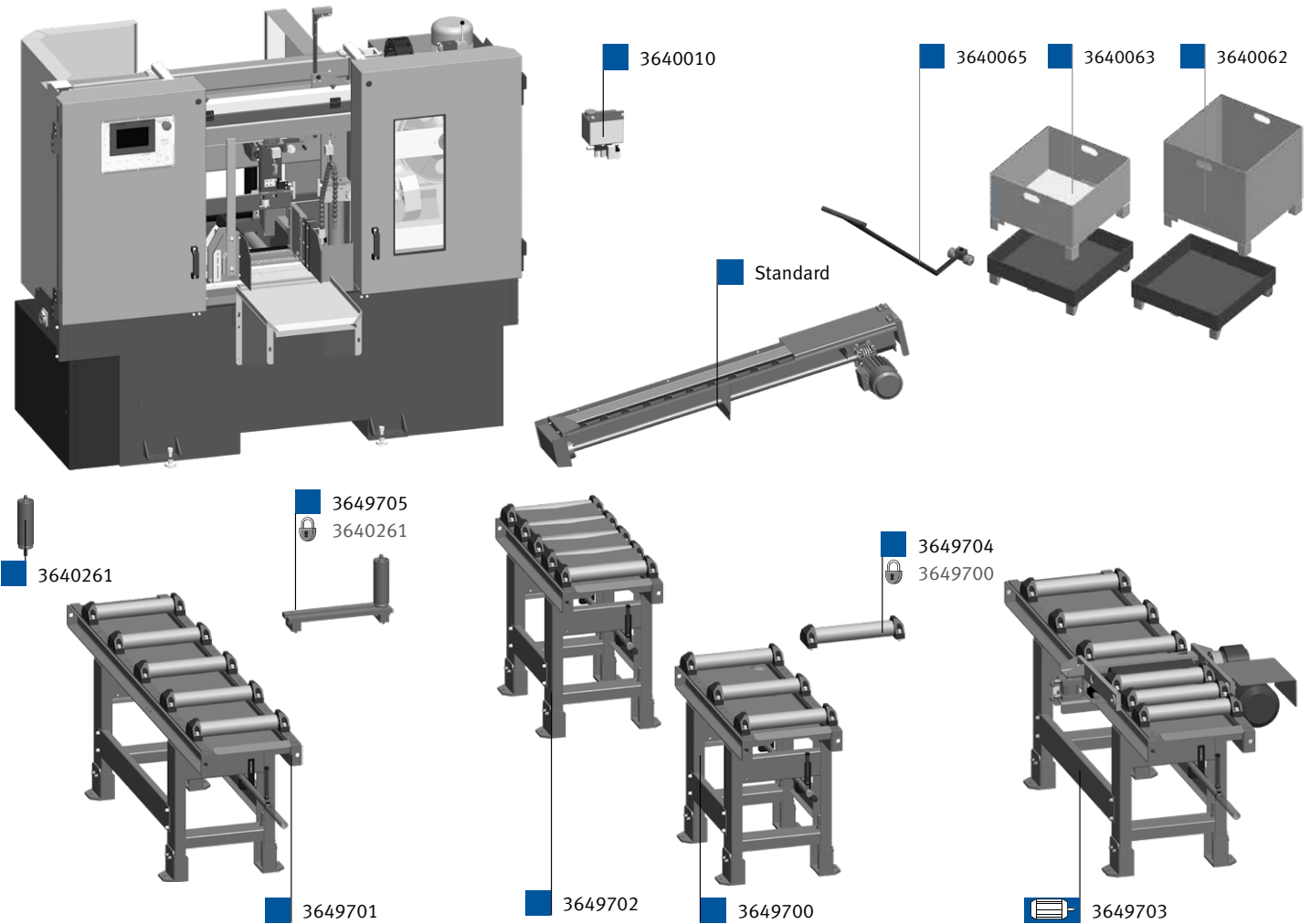
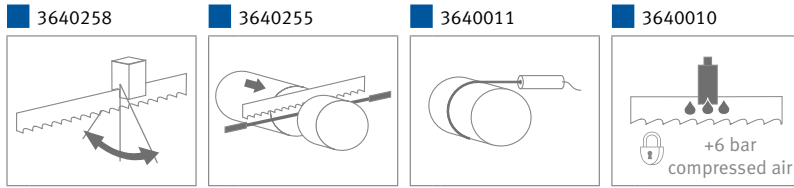

Optional accessories (only available from factory)	Art. no.	Roller conveyors	Art. no.
Cutting line laser	3640011	Roller conveyor 1 000 x 350 mm	3649700
Micro-spraying system	3640010	Roller conveyor 2 000 x 350 mm	3649701
Material start sensor	3640255	Connecting roller conveyor discharge side	
Cut path monitoring	3640258	1 000 x 350 mm with cover plates between rollers	3649702
Accessories		Roller conveyor 2 000 x 350 mm	
Workpiece container	3640062	with one electrically driven roller This roller is hydraulically height adjustable via a separate control	3649703
Swarf container	3640063	Accessories, roller conveyors	
Trolley for swarf container and workpiece container	3640065	lateral guide roller, moving for roller conveyors	3649705
Coolant concentrate 5 l	3601751	Lateral guide roller, rigid	3640261
Spraying agent 5 l, micro-dosing unit	3608020	Additional roller 350 mm	3649704

* must be ordered with your order! **(incl. legs and connecting adapter)

Magnetic drilling
Deburring
Metal grinding
Cutting
Notching & punching
Bending
Presses
Circular saws
Roller conveyors
Metal-cutting band saws

HMBS 400 CNC

Fully-automatic two-column horizontal metal-cutting band saw for industrial use

Automatic

- ▶ For sawing, e.g., stainless steel, tool steel, sections and full materials
- ▶ Precise and sturdy band guides with adjustable tungsten carbide plates
- ▶ Rugged top saw band guide due to linear guides
- ▶ Saw band angled by 7°
- ▶ Automatic band guide setting
- ▶ Doors open at sides to facilitate saw band replacement
- ▶ Material is tensioned before and after cutting
- ▶ Additional hydraulic cut pressure control
- ▶ continuously variable adjustment of the saw band speed from 20 - 100 m/min.
- ▶ With cut probe as standard



! For an exhaustive explanation of the controls, see pages 227 – 231



Scope of delivery:



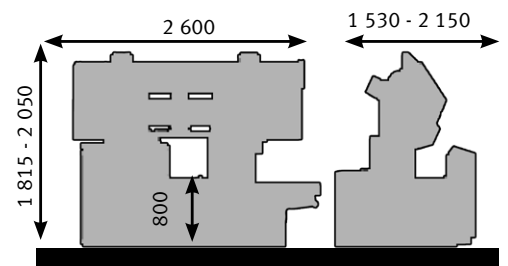

- › Workplace lighting
- › Saw band
- › Operating tool
- › Frequency converter,
- › Material feed 550 mm
- › With cut probe as standard
- › Automatic band guide setting
- › Mechanically driven swarf brush
- › Hydraulic cut pressure control
- › Coolant pump
- › Hydraulic band tensioning unit
- › Chip conveyor with swarf container

Model	HMBS 400 CNC
Art. no.	3690161

Technical specifications	
Motor output 3 x 400 V/50 Hz	3.0 kW
Speed stages	Continuously variable
Saw band speeds	20 - 100 m/min
Saw band dimensions	4 520 x 34 x 1.1
Dimensions (L x W x H)	2 600 x 2 150 x 2 050 mm
Table height material feed	800 mm
Weight	1 300 kg
Minimal cross cut length	10 mm
Minimum size of material	30 mm
Remaining piece length in HA operation	50 mm
Remaining piece length in CNC operation	120 mm
Minimum material feed	3 mm
Feed length	490 mm
Maximum feed length	9 999 mm



Clamping ranges

mm	0°	 a b
	400	X
	250 *	X
	400 x 400	400 x 220

* recommended values

We are always happy to perform sample cutting for your material. Call us for details!



Quality
made in
Europe

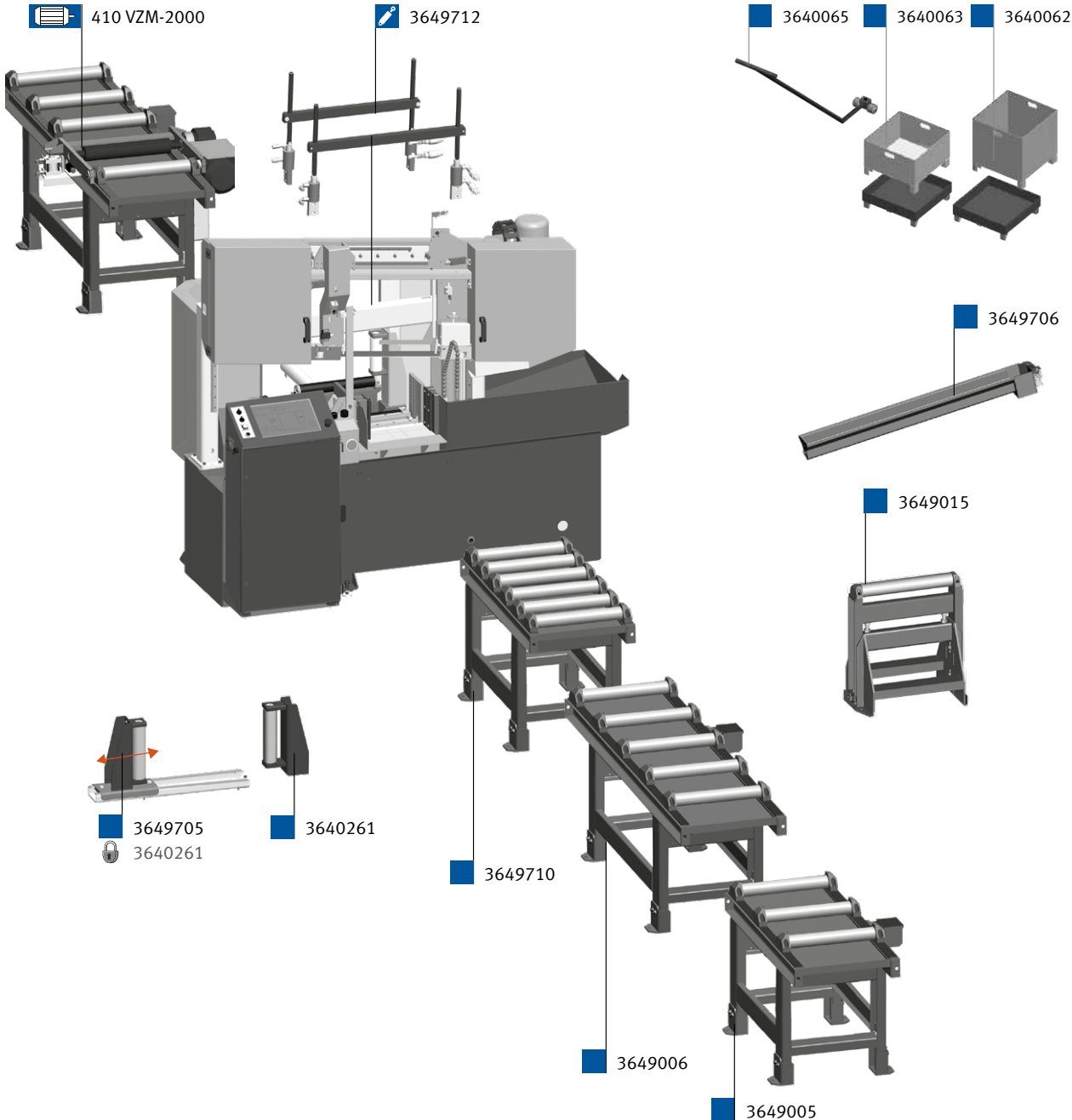
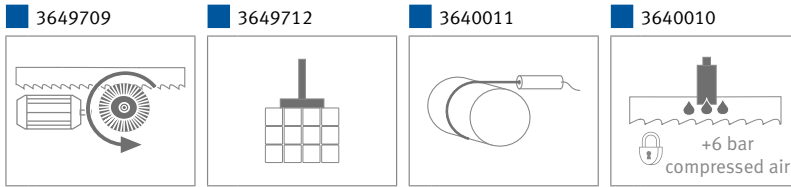

Optional accessories (only available from factory)	Art. no.
Micro-spraying system	3640010
Cutting line laser	3640011
Chip conveyor for stainless steel chips incl. swarf container	3649706
Hydraul. Bundle clamping unit	3649712
motorised swarf brush	3649709
Accessories	
Workpiece container	3640062
Swarf container	3640063
Trolley for swarf container and workpiece container	3640065
Coolant concentrate 5 l	3601751
Spraying agent 5 l, micro-dosing unit	3608020
Roller conveyor lightweight type 250 kg/m	
Roller conveyor 2 000 x 520 mm (6 rollers)	3649350

Roller conveyors	Art. no.
1 000 x 450 mm roller conveyor	3649005
2 000 x 450 mm roller conveyor	3649006
1 000 x 450 mm discharge roller conveyor for short cuts (7 rollers/m) 1 000kg/m	3649710
Roller conveyor 2 000 x 450 mm with one electrically driven roller This roller is hyd- raulically height adjustable via a separate control	3649711
Accessories, roller conveyors	
lateral guide roller, moving for roller conveyors	3649705
Lateral guide roller, rigid	3640261
Roller support, height-adjustable, width 450 mm, load-bearing capacity 700 kg	3649015

* must be ordered with your order! **incl. legs and connecting adapter

More saw bands and
info on Page 283

When ordering a roller conveyor, always state
whether you need a feed or discharge conveyor

Magnetic drilling
Deburring
Metal grinding
Cutting
Notching & punching
Bending
Presses
Circular saws
Roller conveyors
Metal-cutting band saws

HMBS 400 x 400 CNC X

Automatic

Fully-automatic two-column horizontal metal-cutting band saw with ARP system for heavy duty industrial use

- ▶ For sawing, e.g., stainless steel, tool steel, sections and full materials
- ▶ Compact design with short distance between saw arm guide and vice for low-vibration operation
- ▶ Includes frequency converter as standard for continuously variable adjustment of the saw band speed
- ▶ With motorised swarf brush
- ▶ Material feed 700 mm
- ▶ Hydraulic band tensioning unit
- ▶ Saw arm with stroke measuring sensor for determining the position above the workpiece support and an additional bottom end position sensor
- ▶ Rugged saw band guiding with linear guides, with adjustable tungsten carbide plates
- ▶ Offcut clamping



! For an exhaustive explanation of the controls, see pages 227 – 231



▶ Swarfbrush motor



Scope of delivery:



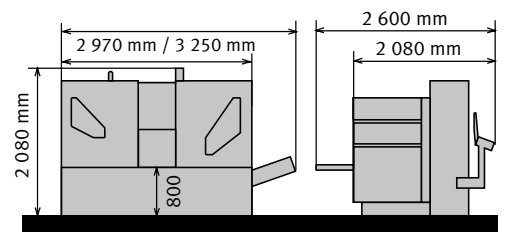

- › Full cladding
- › Saw band
- › Operating tool
- › Chip conveyor with swarf container
- › Workplace lighting
- › Automatic band guide setting
- › Coolant pump
- › Cut probe

We are always happy to perform sample cutting for your material. Call us for details!

Model	HMBS 400 x 400 CNC X
Art. no.	3690079
Technical specifications	
Motor output 3 x 400 V/50 Hz	4.0 kW
Speed stages	Continuously variable
Saw band speeds	20 - 100 m/min
Saw band dimensions	5580 x 41 x 1.3 mm
Dimensions (L x W x H)	2 970 x 2 600 x 2 200 mm
Table height material feed	800 mm
Weight	2 740 kg
Minimal cross cut length	10 mm
Minimum size of material	85 mm
Remaining piece length in HA operation	50 mm
Remaining piece length in CNC operation	110 mm
Minimum material feed	3 mm
Feed length	550 mm
Maximum feed length	9 999 mm



Clamping ranges HMBS 400 x 400

mm	0°	 ^b / _a
	400	X
	400 *	X
	400 x 400	400 x 250

* recommended values

 ^b/_a max. bundle cut

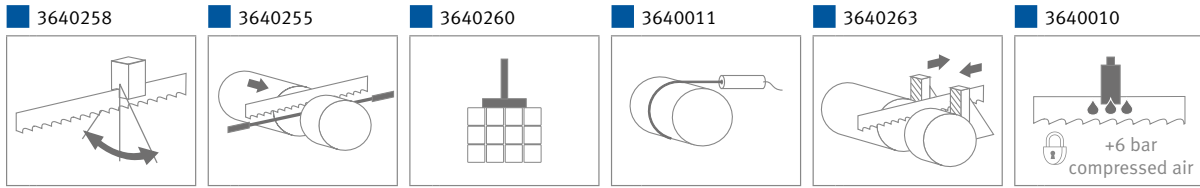

▶ 2-column linear guide with hydr. cylinder



▶ Offcut clamping

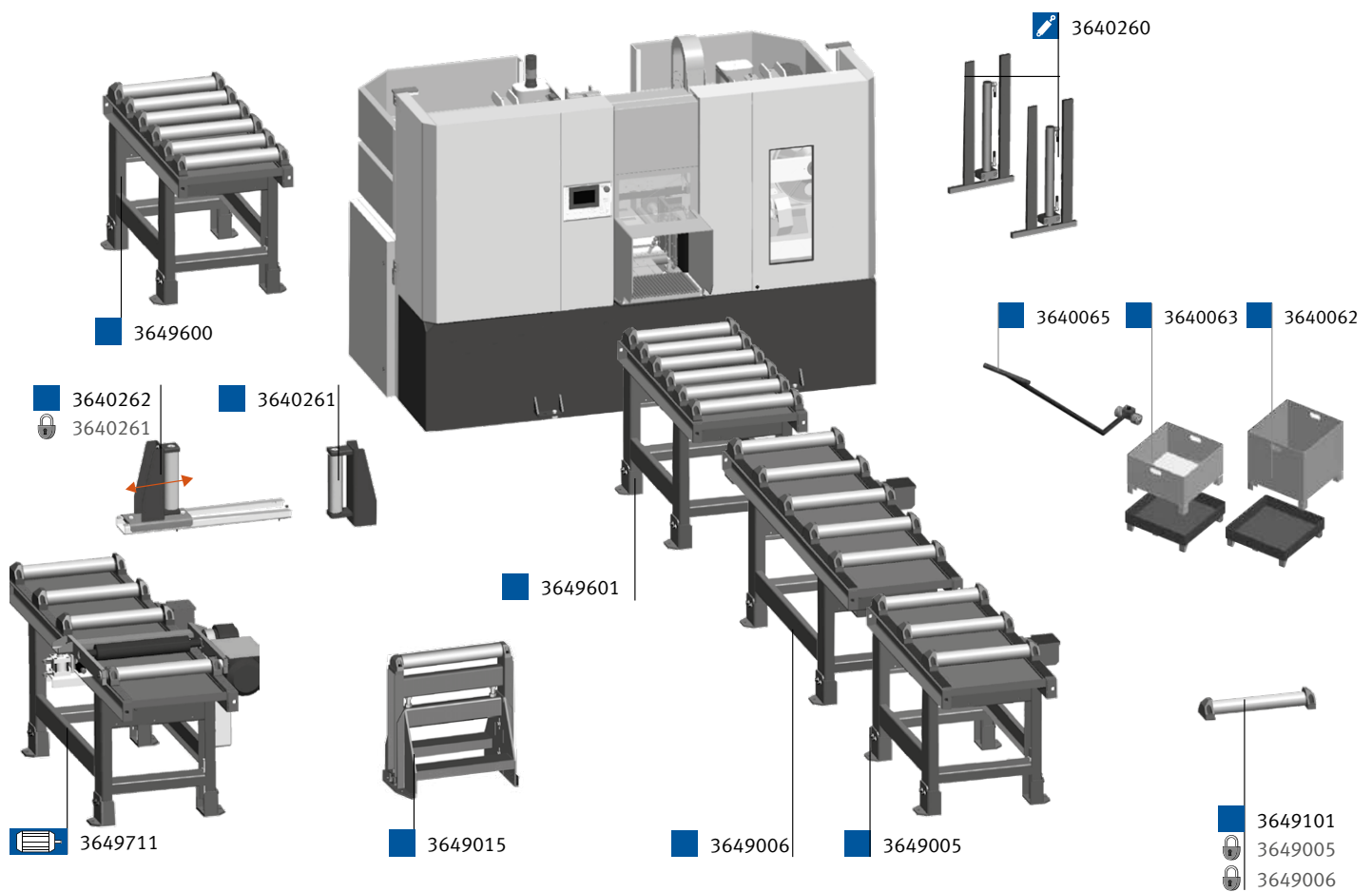

Optional accessories (only available from factory)	Art. no.
Set 2 x hydr. bundle clamping unit	3640260
Cutting line laser	3640011
Micro-spraying system	3640010
Material start sensor	3640255
Cut path monitoring	3640258
Spring-loaded clamping jaws on vice	3640263
Accessories	
Workpiece container	3640062
Swarf container	3640063
Trolley for swarf container and workpiece container	3640065
Coolant concentrate 5 l	3601751
Spraying agent 5 l, micro-dosing unit	3608020

Roller conveyors**	Art. no.
1 000 x 450 mm feed roller conveyor with coolant drain	3649600
1 000 x 450 mm discharge roller conveyor with coolant drain and a guide roller at the side	3649601
1 000 x 450 mm roller conveyor	3649005
2 000 x 450 mm roller conveyor	3649006
Roller conveyor 2 000 x 450 mm with one electrically driven roller. This roller is hydraulically height adjustable via a separate control	3649711
Accessories, roller conveyors	
lateral guide roller, moving for roller conveyors (requires: 3640261*)	3640262
Lateral guide roller, rigid	3640261
Roller support, height-adjustable, width 450 mm, load-bearing capacity 700 kg/m	3649015
Additional roller 450 mm	3649101

* must be ordered with your order! *incl. legs and connecting adapter

More saw bands and info on Page 283

When ordering a roller conveyor, always state whether you need a feed or discharge conveyor

Magnetic drilling
Deburring
Metal grinding
Cutting
Notching & punching
Bending
Presses
Circular saws
Roller conveyors
Metal-cutting band saws

HMBS 510 x 510 CNC X

HMBS 510 x 510 CNC X – fully automatic two-column horizontal metal-cutting band saw with SIEMENS control unit

Automatic

- ▶ For sawing, e.g., stainless steel, tool steel, sections and full materials
- ▶ Material feed 670 mm
- ▶ Saw arm with stroke measuring sensor for determining the cut start position
- ▶ Saw band guide with adjustable tungsten carbide plates
- ▶ Saw band wheels tilted through 25° for a longer saw band service life
- ▶ Clamping of the material upstream and downstream of the cut through two-part vice
- ▶ Line guides on both columns
- ▶ Rugged top saw band guide
- ▶ Hydraulic band tensioning unit
- ▶ With motorised swarf clearing brush
- ▶ Controller with 99 program memory slots with up to 99 setting options



! For an exhaustive explanation of the controls, see pages 227 – 231

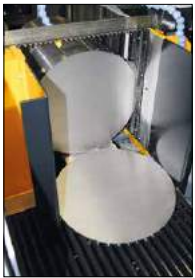

Scope of delivery:

- › Workpiece chute
- › Saw band
- › Operating tool
- › Cut probe
- › Workplace lighting
- › Chip conveyor with swarf container
- › Automatic band guide setting
- › Frequency converter,
- › Coolant pump
- › Cutting channel opens when saw band moves to top position

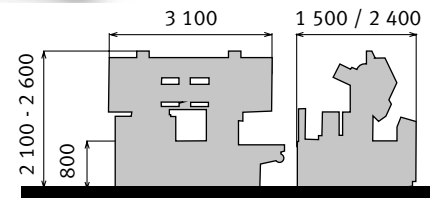

Model	HMBS 510 x 510 CNC X
Art. no.	3690019
Technical specifications	
Motor output 3 x 400 V/50 Hz	7.5 kW
Speed stages	Continuously variable
Saw band speeds	15 - 80 m/min
Saw band dimensions	6 060 x 54 x 1.6 mm
Dimensions (L x W x H)	3100 x 2 400 x 2 600 mm
Table height material feed	800 mm
Weight	6 220 kg
max. feed length for 1 x feed unit	50 mm
min. remaining workpiece length CNC operation	120 mm

HMBS 510 x 510 CNC X	
Minimal cross cut length	10 mm
Minimum size of material	75 mm
Remaining piece length during a cut	50 mm
Remaining piece length in CNC operation	120 mm
Minimum material feed	3 mm
Feed length	670 mm
Maximum feed length	9 999 mm

Clamping ranges HMBS 510 x 510

mm	0°	b
	510	X
	510 *	X
	510 x 530	500 x 450

* recommended values

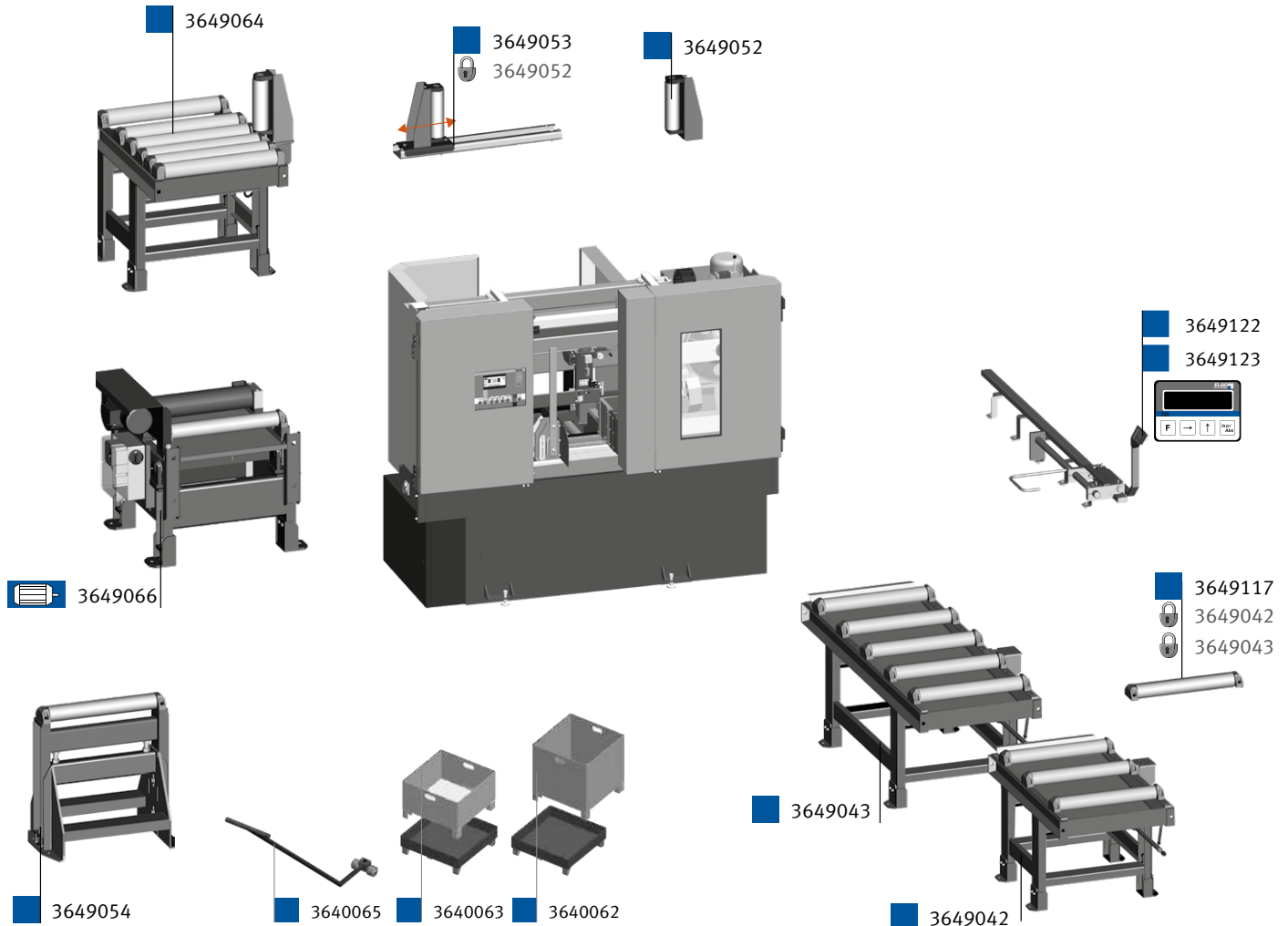
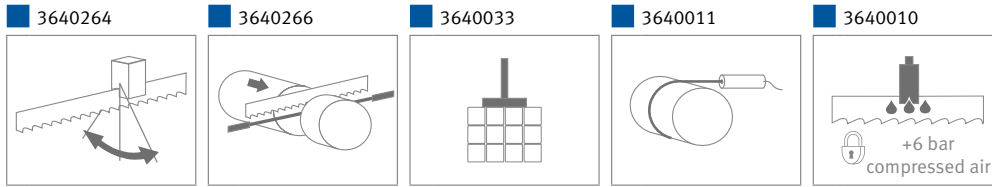

Optional accessories	Art. no.
Set 2 x hydr. bundle clamping unit (for CNC versions)	3640033
Cutting line laser	3640011
Micro-spraying system	3640010
Cut path monitoring	3640264
Precise automatic workpiece feeding	3640266
Accessories	
Workpiece container	3640062
Swarf container	3640063
Trolley for swarf container and workpiece container	3640065
Coolant concentrate 5 l	3601751
Spraying agent 5 l, micro-dosing unit	3608020
Roller and measuring tracks**	
1 000 x 620 mm roller conveyor	3649042
2 000 x 620 mm roller conveyor	3649043
1 000 x 620 mm feed roller conveyor with one guide roller at the side	3649065
Hydraulic lifting roller	3649066

Accessories, roller and measuring tracks	
lateral guide roller, moving for roller conveyors (requires: 3649052*)	3649053
Lateral guide roller, rigid	3649052
Roller support, height-adjustable, width 620 mm, load-bearing capacity 1,000 kg	3649054
Additional roller 620 mm (requires 3649042*/3649043*)	3649117
M42 saw bands for HMBS 510 x 510 CNC X	
6 060 x 54 x 1.6 mm 3-4 TPI Sprint Plus	3655007
6 060 x 54 x 1.6 mm 2-3 TPI Sprint Plus	3655107

* must be ordered with your order! *incl. legs and connecting adapter

More saw bands and info on Page 283

When ordering a roller conveyor, always state whether you need a feed or discharge conveyor

Magnetic drilling
Deburring
Metal grinding
Cutting
Notching & punching
Bending
Presses
Circular saws
Roller conveyors
Metal-cutting band saws

HMBS 5000 CNC X

Fully-automatic two-column horizontal metal-cutting band saw for industrial use and optimal cutting times

Automatic

- ▶ Saw band speed up to 150 m/min
- ▶ Saw band feed with ARP system for automatic feed matching
- ▶ Carbide program for use of carbide saw bands
- ▶ Material feed and sawing frame driven by ball screws
- ▶ Materials library with predefined sawing parameters and characteristics
- ▶ Hydraulic band tensioner
- ▶ Cut progress monitoring
- ▶ Hydraulic saw band guides
- ▶ Coolant tank can be removed to front
- ▶ Automatically adjustable linear saw band guidance
- ▶ Saw band tension double guide
- ▶ Wheels with counterbearing for smoother cutting action
- ▶ Cutting channel flushing



! For an exhaustive explanation of the controls, see pages 227 – 231



Scope of delivery:

- › Saw band
- › Operating tool
- › Two LED workplace lights
- › ARP system
- › Frequency converter,
- › Motorised swarf clearing brush
- › Automatic band guide setting
- › Chip conveyor

! We are always happy to perform sample cutting for your material. Call us for details!

Model	HMBS 5000 CNC X
Art. no.	3691500

Technical specifications	
Motor output 3 x 400 V/50 Hz	15 kW
Speed stages	Continuously variable
Saw band speeds	15 - 150 m/min
Saw band dimensions	7 680 x 54 x 1.6 mm
Dimensions (L x W x H)	3 980 x 2 300 x 2 900 mm
Table height material feed	800 mm
Weight	7 735 kg

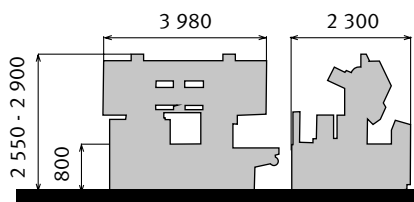

Clamping ranges		
mm	0°	
	550	x
	550*	x
	550 x 620	550x350
	550x550	x

* recommended values for full material

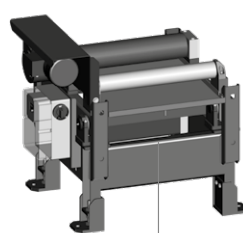
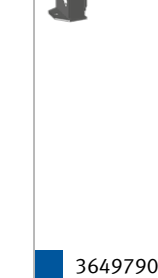
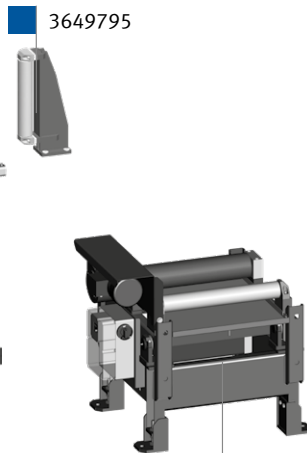
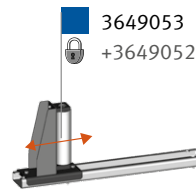
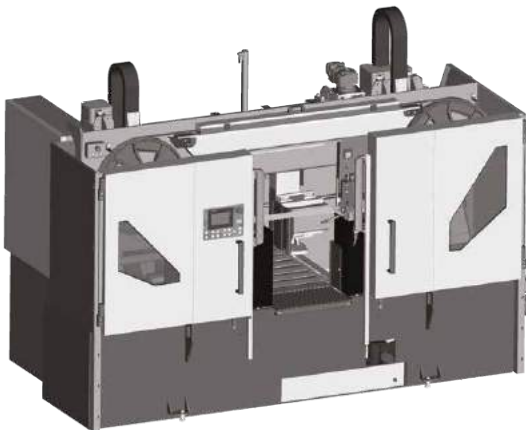
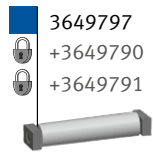
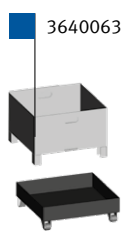
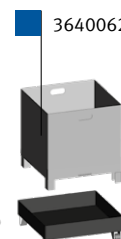
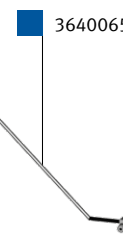
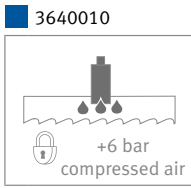
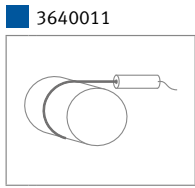

Optional accessories (only available from factory)	Art. no.
Chip conveyor	3640131
Cutting line laser	3640011
Micro-spraying system	3640010
Accessories	
Workpiece container	3640062
Swarf container	3640063
Trolley for swarf and workpiece container	3640065
Coolant concentrate 5 l	3601751
Spraying agent 5 l, micro-dosing unit	3608020
Roller conveyors heavy-duty type 1 700 kg/m	
1 000 x 620 mm roller conveyor	3649042
2 000 x 620 mm roller conveyor	3649043
Hydraulic lifting roller	3649066
Accessories, heavy-duty roller conveyors	
height-adjustable roller	3649054
Lateral guide roller, rigid	3649052
lateral Guide roller, moving	3649053
Additional roller 620 mm	3649117
Roller conveyors ultra-heavy-duty type 2 000 kg/m	
Roller conveyor 1 000 x 570 mm with hardened rollers	3649790
Roller conveyor 2 000 x 570 mm with hardened rollers	3649791
Accessories, ultra-heavy-duty roller conveyors	
lateral guide roller, rigid - height 650 mm	3649795
lateral guide roller, moving - height 650	3649796
Additional roller 570 mm	3649797

height-adjustable roller	3649054
Lateral guide roller, rigid	3649052
lateral Guide roller, moving	3649053
Additional roller 620 mm	3649117
Roller conveyors ultra-heavy-duty type 2 000 kg/m	
Roller conveyor 1 000 x 570 mm with hardened rollers	3649790
Roller conveyor 2 000 x 570 mm with hardened rollers	3649791
Accessories, ultra-heavy-duty roller conveyors	
lateral guide roller, rigid - height 650 mm	3649795
lateral guide roller, moving - height 650	3649796
Additional roller 570 mm	3649797

* must be ordered with your order! ** Explanations, see page 283

More saw bands and info on Page 283

When ordering a roller conveyor, always state whether you need a feed or discharge conveyor

HMBS 700 x 750 HA X

Semi-automatic two-column horizontal metal-cutting band saw with SIEMENS control unit for heavy-duty industrial use

Semi-automatic

- ▶ Linear guides on both columns ensure perfect cutting results
- ▶ Rugged 3-phase motor including overload protection
- ▶ The vice is equipped with a long stroke cylinder to compensate for larger differences in cross-sections
- ▶ Band guide with adjustable tungsten carbide plates
- ▶ Hydraulic vice pressure control



▶ Front band guide automatically moves in parallel with the moving vice for more precise saw band guiding



! For an exhaustive explanation of the controls, see pages 227 – 231



Scope of delivery:

- > Saw band
- > Operating tool
- > Workplace lighting
- > Motorised swarf brush
- > Frequency converter,
- > Coolant pump
- > Hydraulic band tensioning unit



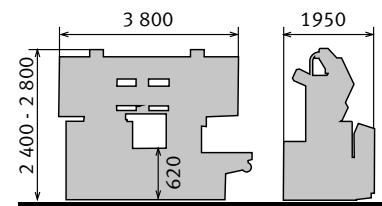

We are always happy to perform sample cutting for your material. Call us for details!

Model	HMBS 700 x 750 HA X
Art. no.	3690082

Technical specifications	
Motor output 3 x 400 V/50 Hz	11 kW
Speed stages	Continuously variable
Saw band speeds	15 - 80 m/min
Saw band dimensions	7 680 x 67 x 1.6 mm
Dimensions (L x W x H)	4 100 x 1 950 x 2 700 mm
Table height material feed	620 mm
Weight	5950 kg



Clamping ranges

mm	0°	 a x b
	700	X
	700 *	X
	750 x 700	750 x 450

* recommended values for full material

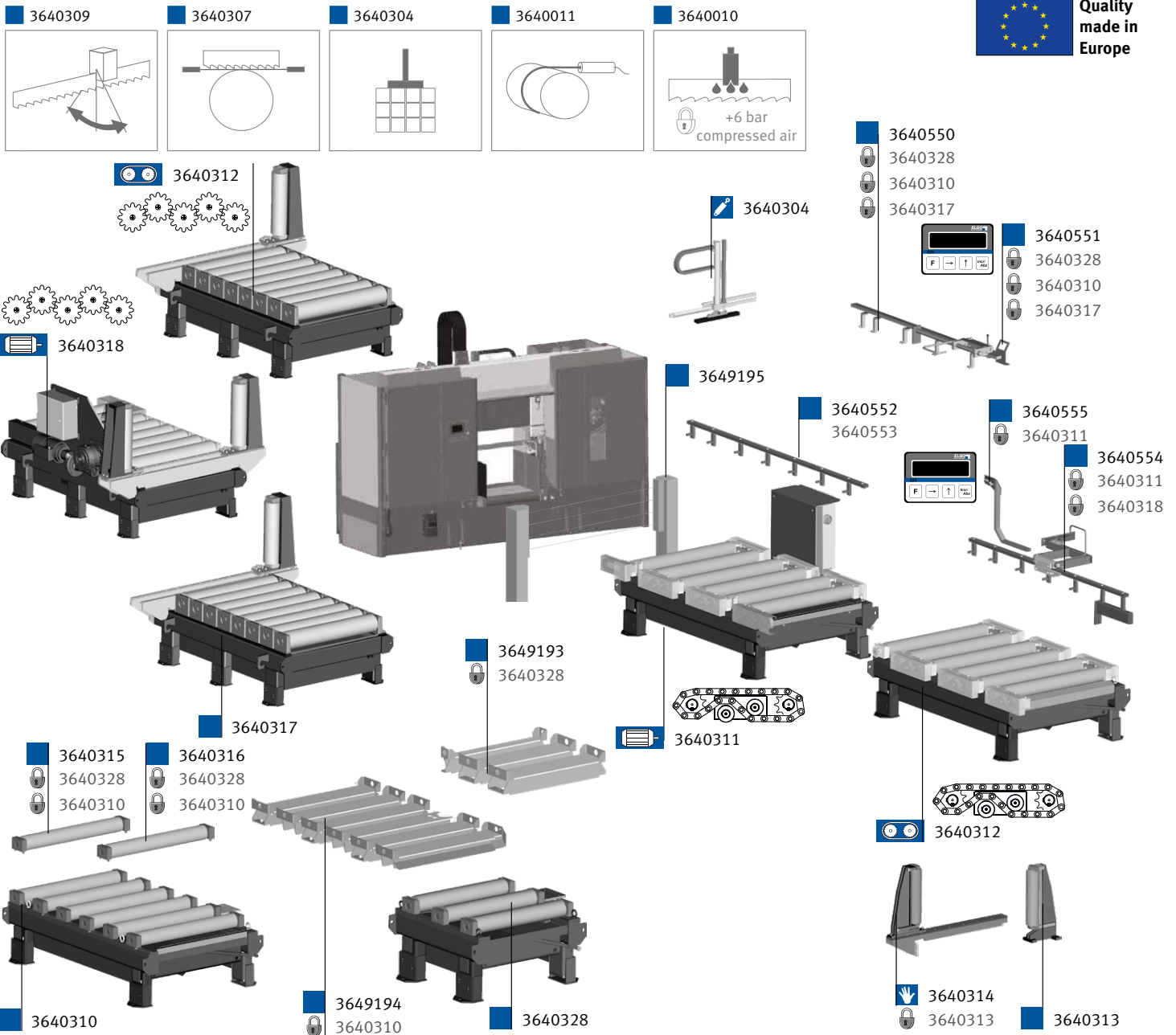

Optional accessories (only available from factory)	Art. no.
Hydraul. Bundle clamping unit	3640304
Cutting line laser	3640011
Micro-spraying system	3640010
Material start sensor	3640307
Cut path monitoring	3640309
Safety light barrier	3649195
Roller conveyors	
1 000 x 800 mm roller conveyor	3640328
2 000 x 800 mm roller conveyor	3640310
Motorised roller conveyor 2 000 x 800 mm	3640311
2 000 x 800 mm motorised extension	3640312
requires: 3640311*	
2 000 x 800 mm feed/discharge roller conveyor heavy-duty version	3640317
2 000 x 800 mm feed/discharge roller conveyor, motorised / heavy-duty version	3640318
2 000 x 800 mm extension motorised / heavy duty version	3640319

Accessories, roller and measuring tracks	Art. no.
lateral guide roller, moving for roller conveyors (requires: 3640313*)	3640314
Lateral guide roller, rigid	3640313
Additional roller 800 mm (requires 3640328*/3640310*)	3640315
Idler rollers tempered to 55 HRC (requires 3640328/ 3640310)	3640316
1 m casing for roller conveyor (requires 3640328)	3649193
2 m casing for roller conveyor (requires 3640310)	3649194
2 m stop with measuring scale - heavy-duty version (requires 3640328* /3640310* /3640317*)	3640550
2 m stop with dig. measuring display - heavy duty version, (requires 3640328* /3640310* /3640317*)	3640551
2 m extension for stop with scale and measuring scale - heavy duty version	3640552
2 m extension for stop with digital display - heavy duty version	3640553
Electro-mechanical stop for motor. Roller conveyor with scale - heavy duty version (requires 3640311* /3640318*)	3640554
Electro-mechanical stop for motor. Roller conveyor with digital display - heavy duty version (requires: 3640311*)	3640555
M42 saw bands	
7 680 x 67 x 1.6 2-3 TPI Sprint Plus	3655410
7 680 x 67 x 1.6 3-4 TPI Sprint-Medium-VS	3655411

More saw bands and info on Page 283

When ordering a roller conveyor, always state whether you need a feed or discharge conveyor

* must be ordered with your order! *incl. legs and connecting adapter

Magnetic drilling
Deburring
Metal grinding
Cutting
Notching & punching
Bending
Presses
Circular saws
Roller conveyors
Metal-cutting band saws

HMBS 700 x 750 CNC X

Automatic two column horizontal metal-cutting band saw with ARP system for heavy-duty industrial use

Automatic

- ▶ The vices are equipped with long stroke cylinders
- ▶ Clamping pressure control
- ▶ the fixed, hydraulically-controlled jaw on the vice moves back by 5 mm, thus improving the workpiece feed
- ▶ End switches control the upper and lower end positions of the saw arm
- ▶ Clamping of the material upstream and downstream of the cut through two-part vice
- ▶ Band guide with adjustable tungsten carbide plates
- ▶ Compact design with short distance between saw arm guide and vice for low-vibration operation
- ▶ electronic setting of the saw arm's top and bottom positions
- ▶ permanent monitoring of the saw band and feed speeds
- ▶ USB interface



! For an exhaustive explanation of the controls, see pages 227 – 231



Scope of delivery:

- › Saw band
- › Operating tool
- › Workplace lighting
- › Autom. band guide setting
- › Motorised swarf clearing brush
- › Frequency converter,
- › Swivelling control panel
- › Coolant pump
- › Hydraulic band tensioning unit

We are always happy to perform sample cutting for your material. Call us for details!

Model	HMBS 700 x 750 CNC X
Art. no.	3690083

Technical specifications	
Motor output 3 x 400 V/50 Hz	11 kW
Speed stages	Continuously variable
Saw band speeds	15 - 80 m/min
Saw band dimensions	7 680 x 67 x 1.6
Dimensions (L x W x H)	7 000 x 2 750 x 2 700 mm
Table height material feed	620 mm
Weight	12 500 kg

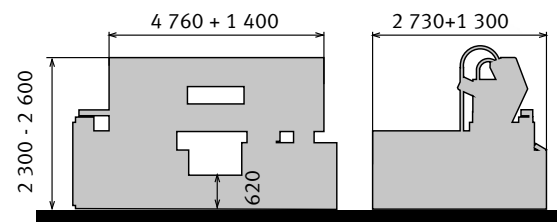

Clamping ranges

mm	0°	a x b
	700	x
	700 *	x
	750 x 700	750 x 450

* recommended values

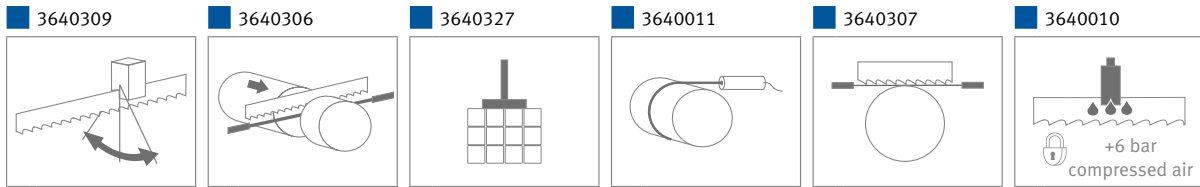

► Clamping of the material upstream and downstream of the cut through two-part vice

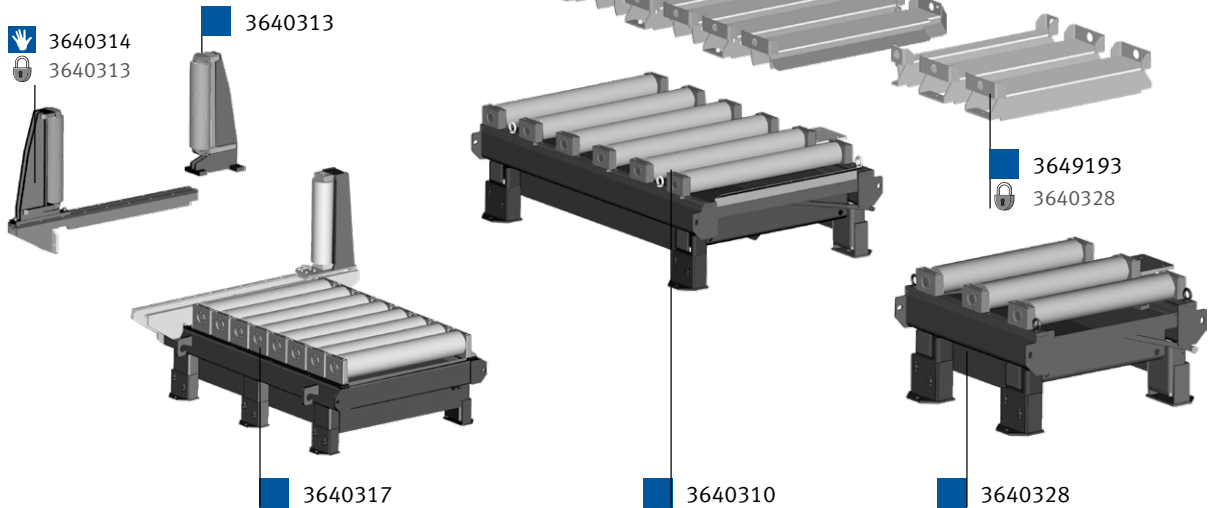
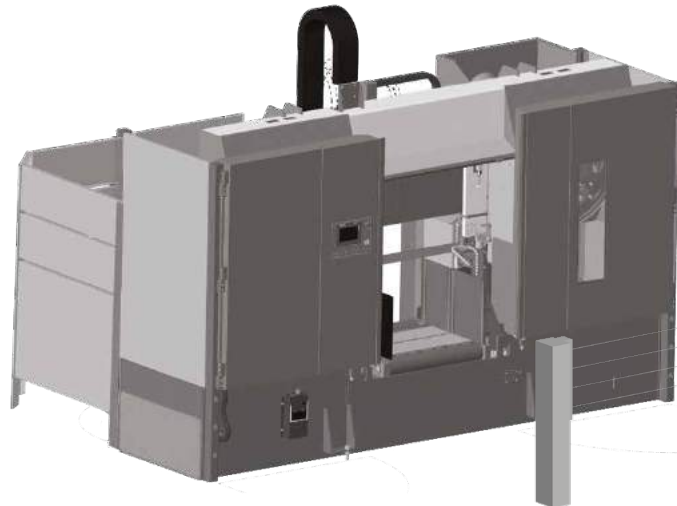

Optional accessories (only available from factory)	Art. no.
Hydraul. Bundle clamping unit	3640327
Cutting line laser	3640011
Micro-spraying system	3640010
Automatic material start sensor **	3640306
Automatic detection of the top material end point **	3640307
Cut path monitoring **	3640309
Safety light barrier	3649195
Roller conveyors	
1 000 x 800 mm roller conveyor	3640328
2 000 x 800 mm roller conveyor	3640310
2 000 x 800 mm feed/discharge roller conveyor heavy-duty version	3640317

Accessories, roller and measuring tracks	Art. no.
lateral guide roller, moving for roller conveyors (requires: 3640313*)	3640314
Lateral guide roller, rigid	3640313
Additional roller 800 mm (requires 3640328*/3640310*)	3640315
Idler rollers tempered to 55 HRC (requires 3640328/ 3640310)	3640316
1 m casing for roller conveyor (requires 3640328)	3649193
2 m casing for roller conveyor (requires 3640310)	3649194
M42 saw bands	
7 680 x 67 x 1.6 2-3 TPI Sprint Plus	3655410
7 680 x 67 x 1.6 3-4 TPI Sprint-Medium-VS	3655411

* must be ordered with your order! ** Explanations, see page 283

HMBS 850 x 1 000 CNC X

Fully-automatic two-column horizontal metal-cutting band saw with ARP system for heavy-duty industrial applications

Automatic

- ▶ For sawing, e.g., stainless steel, tool steel, sections and full materials
- ▶ Material feed 700 mm
- ▶ Saw band guide with adjustable tungsten carbide plates
- ▶ Robust, automatically adjustable saw band guide with cooling system
- ▶ With hydraulic band tensioning
- ▶ Line guides on both columns
- ▶ With motorised swarf clearing brush



! For an exhaustive explanation of the controls, see pages 227 – 231



Scope of delivery:

- > Saw band
- > Operating tool
- > Workplace lighting
- > Chip conveyor
- > Frequency converter,
- > Material feed 700 mm
- > Coolant pump



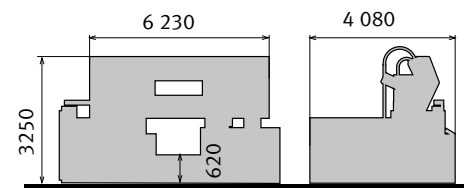

We are always happy to perform sample cutting for your material. Call us for details!

Model	HMBS 850 x 1000 CNC X
Art. no.	3690094

Technical specifications	
Motor output 3 x 400 V/50 Hz	11 kW
Speed stages	Continuously variable
Saw band speeds	15–80 m/min
Saw band dimensions	9 490 x 67 x 1.6 mm
Dimensions (L x W x H)	6 230 x 4 080 x 3 250 mm
Table height material feed	620 mm
Weight	13 700 kg
Remaining piece length	50 mm



Clamping ranges

mm	0°	 $\begin{matrix} b \\ a \\ a \times b \end{matrix}$
	850	x
	850 *	x
	1 000 x 850	1 000 x 610

* recommended values

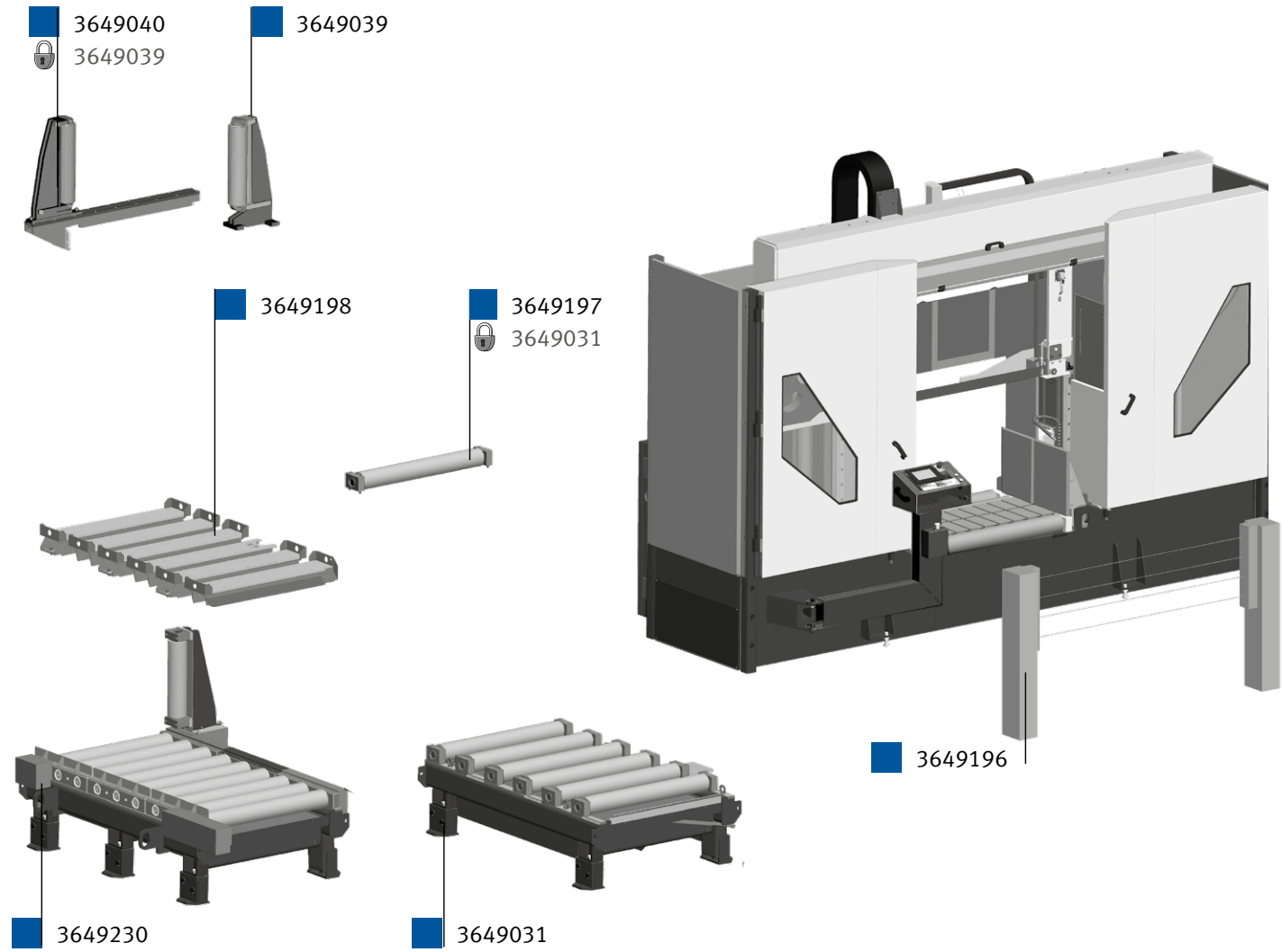
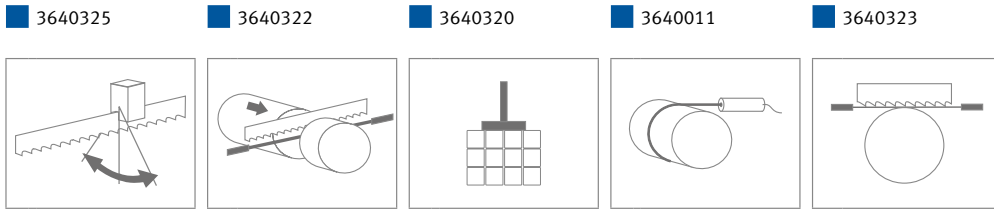

Optional accessories (only available from factory)	Art. no.	Accessories, roller conveyors 1 000 mm	Art. no.
Light barrier	3649196	lateral guide roller, moving for roller conveyors (requires: 3649039*)	3649040
Cutting line laser	3640011	Lateral guide roller, rigid	3649039
Automatic detection of the top material end point **	3640323	Additional roller 1 000 mm (requires: 3649031*)	3649197
Cut path monitoring **	3640325	2 m casing for roller conveyor (requires 3649031*)	3649198
Roller conveyors		M42 saw bands	
2 000 x 1 000 mm roller conveyor 5 000 kg/m	3649031	9 490 x 67 x 1.6 2-3 TPI Sprint-Medium-VS	3655011
2 000 x 1 000 mm heavy-duty roller conveyor, 7000 kg/m	3649230	9 490 x 67 x 1.6 3-4 TPI Sprint Plus	3655111

More saw bands and info on Page 283

When ordering a roller conveyor, always state whether you need a feed or discharge conveyor

* must be ordered with your order! ** Explanations, see page 283

Magnetic drilling
Deburring
Metal grinding
Cutting
Notching & punching
Bending
Presses
Circular saws
Roller conveyors
Metal-cutting band saws

HMBS 1200 x 1400 HA X

Semi-automatic/fully-automatic two column horizontal metal-cutting band saw with ARP system for heavy-duty industrial use

Semi-automatic

- ▶ Developed for cutting full materials
- ▶ A hydraulic system controls the machines automated work sequences
- ▶ Band guide with adjustable tungsten carbide plates
- ▶ End switches control the upper and lower end positions of the saw arm
- ▶ Linear guides on both columns ensure perfect cutting results
- ▶ Wheels tilted for a longer saw band service life



! For an exhaustive explanation of the controls, see pages 227 – 231



- ▶ with solid, precision 2-column guide
- ▶ Linear guides on both columns ensure perfect cutting results

▶ Chip conveyor as standard

Scope of delivery:

- > Saw band
- > Operating tool
- > Two workplace lights
- > ARP system
- > Chip conveyor
- > Frequency converter,
- > Cooling system on the saw band guides
- > Motorised swarf clearing brush
- > Automatic band guide setting

We are always happy to perform sample cutting for your material. Call us for details!

HMBS 1 200 x 1 400 HA X
Fig. with optional 2nd vice

Model	HMBS 1200 x 1400 HA X
Art. no.	3690052

Technical specifications	
Motor output 3 x 400 V/50 Hz	11 kW
Speed stages	Continuously variable
Saw band speeds	15–80 m/min
Saw band dimensions	11 650 x 80 x 1.6 mm
Dimensions (L x W x H)	5 200 x 2 350 x 4 000 mm
Table height material feed	800 mm
Weight	25 000 kg

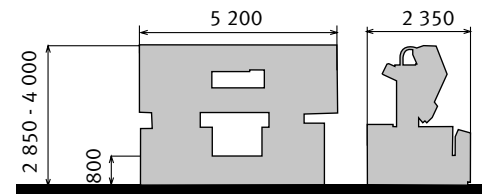

Clamping ranges

mm	□ 0°
○	1 200
●	1 200 *
□	1 200 x 1 400

* recommended values

Accessories for HMBS 1200 x 1400 HA X

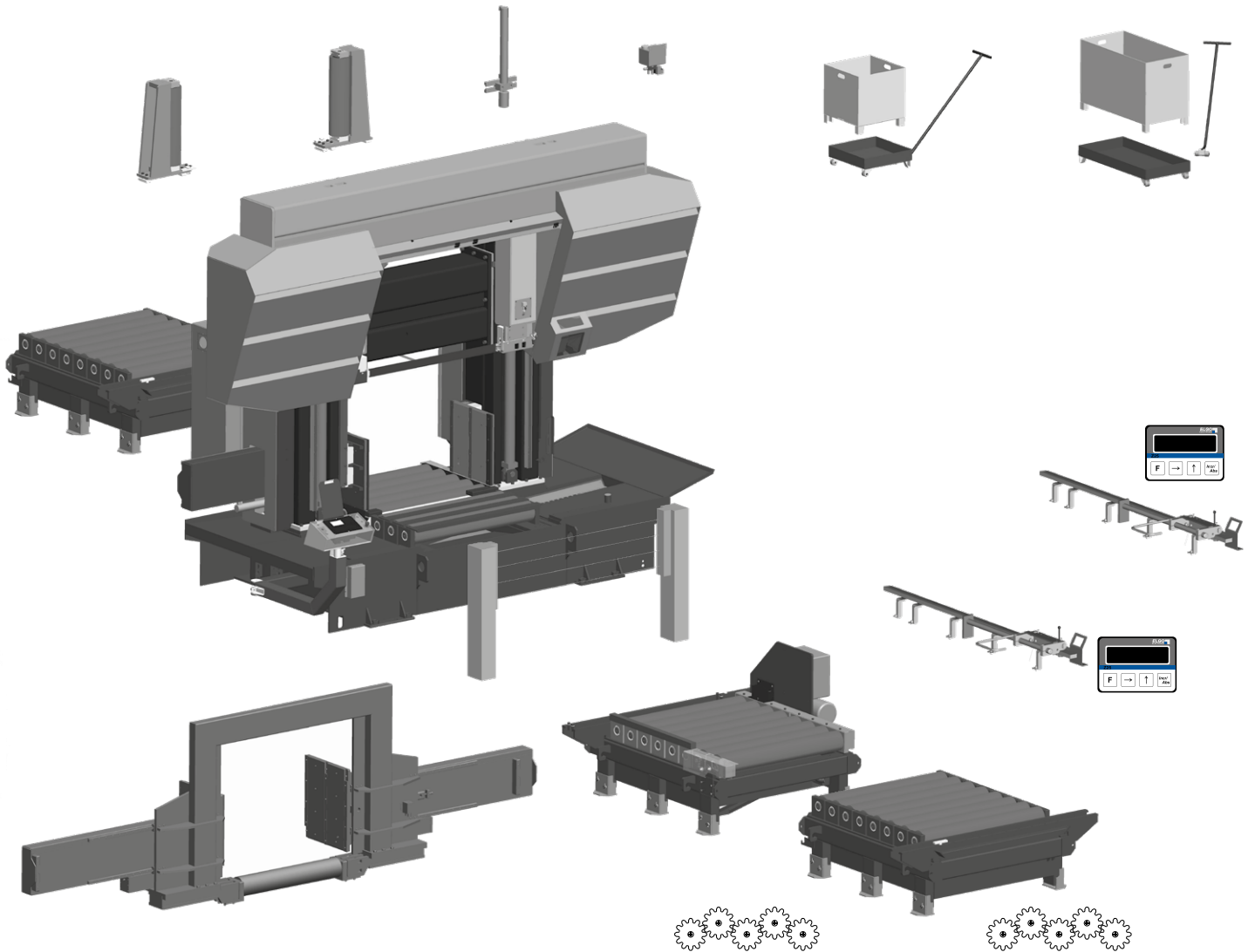
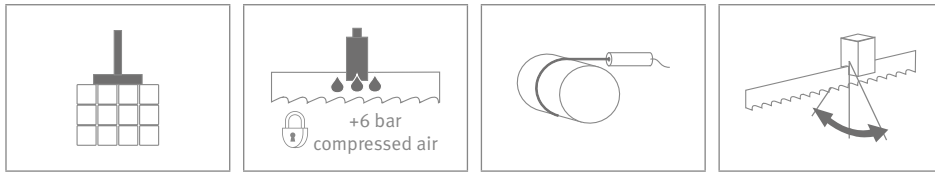

! Accessories for HMBS 1 200 x 1 400 on request!

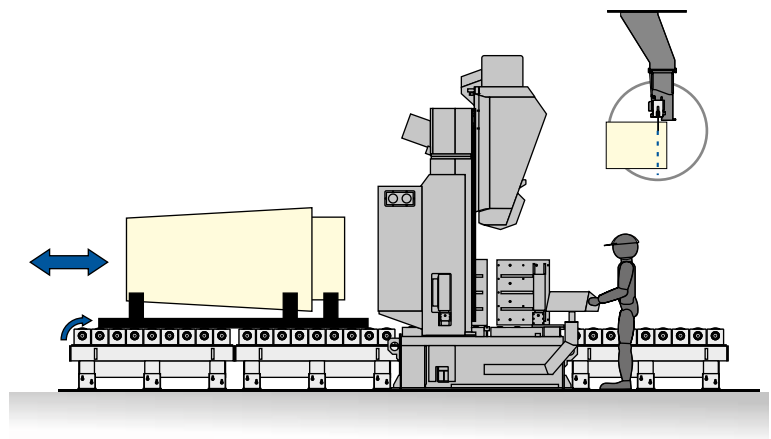

Magnetic drilling
Deburring
Metal grinding
Cutting
Notching & punching
Bending
Presses
Circular saws
Roller conveyors
Metal-cutting band saws

HVMBS 850 x 1 000 Xtreme

Semi-automatic two column horizontal metal-cutting horizontal/vertical band saw with moving material support table for heavy-duty industrial use

Semi-automatic

- ▶ Developed for cutting full materials
- ▶ Material movements are handled by a moving clamping table borne on a linear guide and actuated by an independent control
- ▶ Saw band swivels through 90° - ideal for notching in blocks of solid material
- ▶ Automatic band guide with adjustable tungsten carbide plates and cooling system
- ▶ A hydraulic system controls the machines automated work sequences
- ▶ With an electrically driven swarf clearing brush for optimum cleaning and maintenance of the saw band
- ▶ The wheels are tilted for a longer saw band service life
- ▶ With continuously variable saw band speed setting
- ▶ End switches control the upper and lower end positions of the saw arm
- ▶ Saw arm with stroke measuring sensor for determining the position above the workpiece support plus an additional bottom end position sensor



! For an exhaustive explanation of the controls, see pages 227 – 231

Scope of delivery:

- › Saw band
- › Operating tool
- › Two workplace lights
- › ARP system
- › Chip conveyor
- › Moving clamping table with 2 500 mm stroke
- › Automatic band guide setting
- › Frequency converter



Model	HVMBS 850 x 1 000 Xtreme
Art. no.	3690020

Technical specifications	
Motor output 3 x 400 V/50 Hz	11.0 kW
Speed stages	Continuously variable
Saw band speeds	15–80 m/min
Saw band dimensions	9 080 x 67 x 1.6 mm
Dimensions (L x W x H)	5 200 x 7 534 x 4 000 mm
Table height material feed	800 mm
Weight	12 500 kg

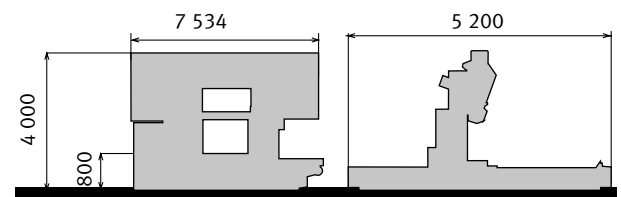

We are always happy to perform sample cutting for your material. Call us for details!

Clamping ranges

mm	0°
	850
	1 000 x 850
	2 000 x 850

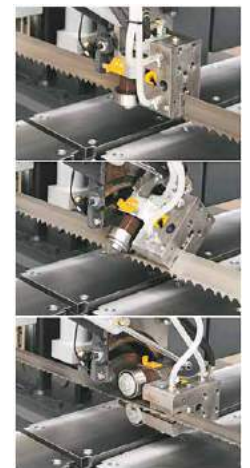
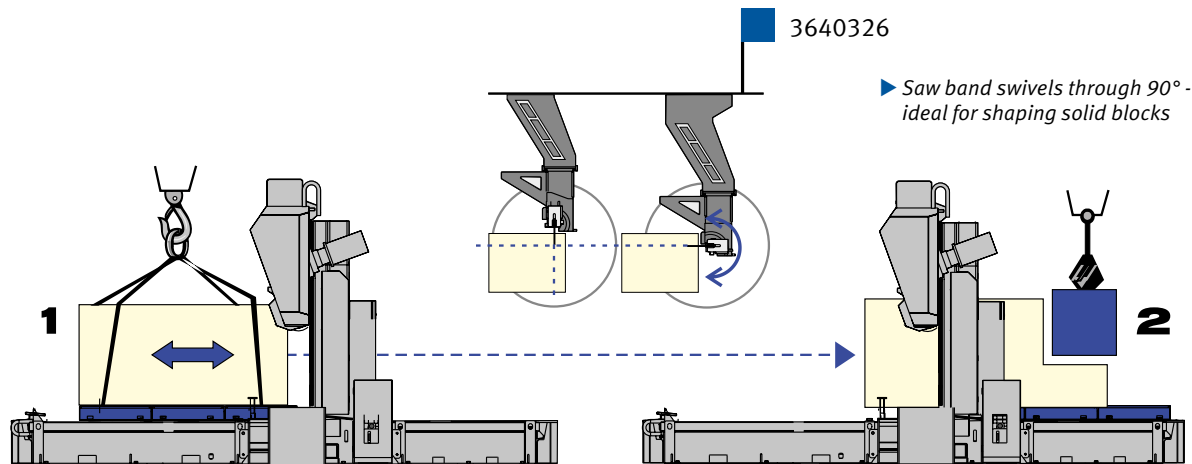
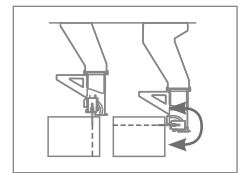
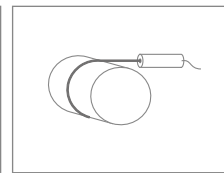
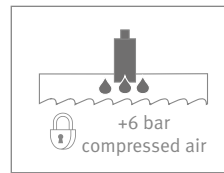
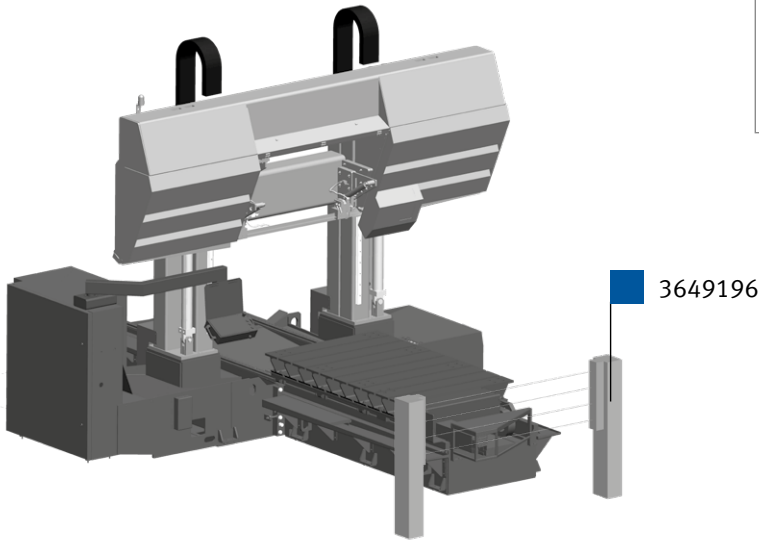

Optional accessories	Art. no.
Micro-spraying system	3640010
Cutting line laser	3640011
Safety light barrier	3649196
Hydraulically swivelling saw band guide	3640326

More saw bands and info on Page 283

When ordering a roller conveyor, always state whether you need a feed or discharge conveyor

! Further accessories for HVMB5 850 x 1 000 Xtreme on request!

HVMBS 1 200 x 1 600 Xtreme

Semi-automatic two column horizontal/vertical metal-cutting band saw with moving feed table for heavy-duty industrial use

Semi-automatic

- ▶ Developed for cutting full materials
- ▶ Material movements are handled by a moving clamping table borne on a linear guide and actuated by an independent control
- ▶ Saw band swivels through 90° - ideal for notching in blocks of solid material
- ▶ Automatic band guide with adjustable tungsten carbide plates and cooling system
- ▶ A hydraulic system controls the machines automated work sequences
- ▶ With an electrically driven swarf clearing brush for optimum cleaning and maintenance of the saw band
- ▶ The wheels are tilted for a longer saw band service life
- ▶ With continuously variable saw band speed setting
- ▶ End switches control the upper and lower end positions of the saw arm
- ▶ Saw arm with stroke measuring sensor for determining the position above the workpiece support plus an additional bottom end position sensor



! For an exhaustive explanation of the controls, see pages 227 – 231

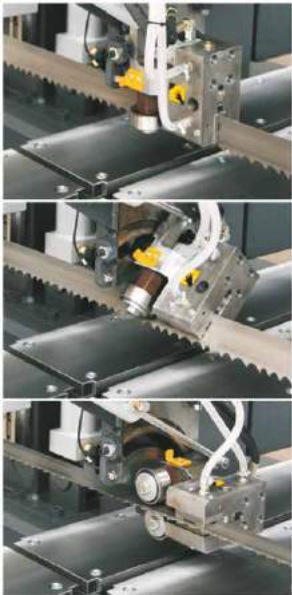

▶ Saw band swivels through 90° - ideal for notching in blocks of solid material



Scope of delivery:

- › Saw band
- › Operating tool
- › Automatic band guide setting
- › Chip conveyor
- › Electrically driven swarf clearing brush
- › Workplace lighting
- › Frequency converter,

We are always happy to perform sample cutting for your material. Call us for details!

Model	HVMBS 1 200 x 1 600 Xtreme
Art. no.	3690032

Technical specifications	
Motor output 3 x 400 V/50 Hz	11 kW
Speed stages	Continuously variable
Saw band speeds	15–80 m/min
Saw band dimensions	11 650 x 80 x 1.6 mm
Dimensions (L x W x H)	5 200 x 7 653 x 4 000 mm
Table height material feed	800 mm
Weight	30 350 kg

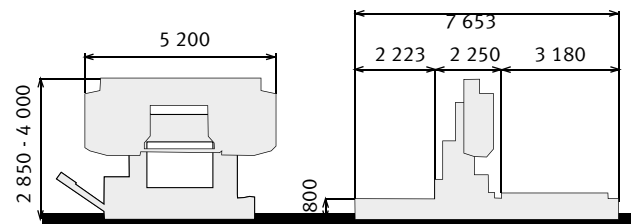

Clamping ranges

mm	0°
	1 200
	1 600 x 1 200
	1 600 x 3 000



▶ Moving clamping table with 2 500 mm stroke and T grooves

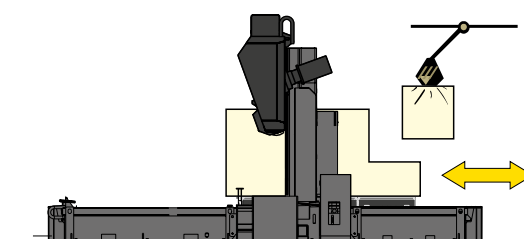
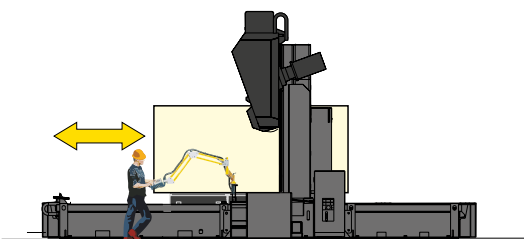
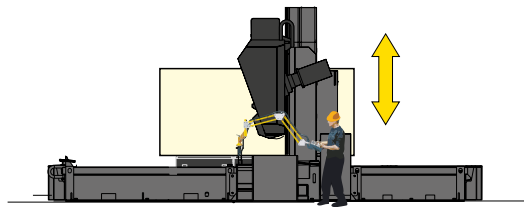
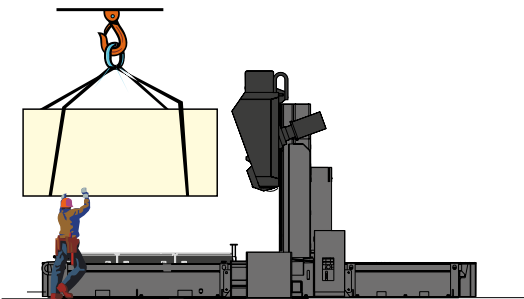

Material feed on HVMBS 1 200 x 1 600 Xtreme

- ▶ Material feed by clamping table
- ▶ The table is borne on linear guides and is actuated by a separate control
- ▶ The feed speed is continuously variable
- ▶ Solid work table with T grooves

! Accessories for HVMBS 1 200 x 1 600 Xtreme on request!

Overview of saw bands

Information on metal-cutting band saws and saw bands

Clamping the material

- ▶ Clamp the material to allow for vibration-free operation of the saw band to the extent possible
- ▶ In case of bundle cutting, weld the ends if needed (this improves the cut performance and service life)

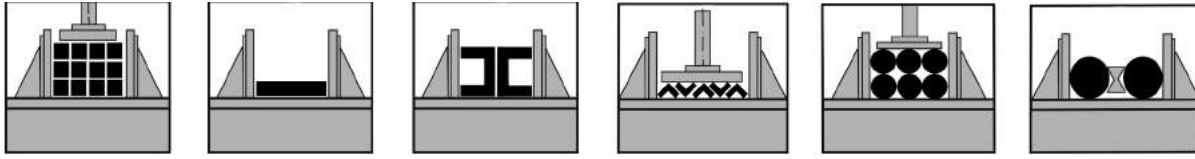

Coolant

The coolant helps to prevent overheating of the saw tooth and the workpiece, and it transports the swarf away from the cut location. It is normal to saw all steels while using a cooling emulsion. Cast iron is normally dry sawn. Cutting oil helps you achieve good cutting results when sawing case-hardened steels, higher-alloyed tool steels, heat-treated steels, stainless steels (VA) and titanium.

Running in correctly: a guarantee for long service lives.

Like all tools, saw bands need to be correctly run in. This guarantees the longest service lives and it saves tool and tooling costs. The very sharp tooth tips must not be fully exposed to load when you start cutting. Premature overload can cause the tooth tips to break out. Correct running in helps to round the blades perfectly.

Bi-metal saw bands

For the first 300 - 500 cm² of cut surface, the saw band runs at half the feed speed and the recommended cutting speed. After the running in time, the feed is gradually increased to the intended value. If vibrations or vibration noises occur at the start of cutting, you need to make minor adjustments to the cutting speed.

Carbide saw bands

We recommend the following application values for at least the first 30 minutes:

Material diameters up to 600 mm cutting speed = 30 m/min. (feed speed = 5 mm/min)

Material diameters above 600 mm cutting speed = 25 m/min. (feed speed = 3 mm/min)

The cutting and feed speeds can gradually be increased simultaneously to the desired maximum value when the saw band is completely vibration free.

Cutting speed and feed

The cutting speed (band speed) depends on the strength, grade and cross-section of the material to be sawed. The higher the strength, the lower the speed you need to select. Smaller diameters can be sawed at higher speeds than larger diameters. Thin-walled pipes and sections, and sharp edges, are sawed at a low speed, and at a constant feed rate (pressure) where possible.

Materials	Cutting speed in m/min (M42)
• Construction steel/Machining steel	80-90
• Case-hardened steels/Heat-treated steels	45-75
• Unalloyed tool steels/Rolled steels	40-60
• Alloyed tool steels/High-speed steels	30-40
• Stainless steels	20-35
• Heat resistant steels/Highly heat-resistant alloys	15-25

The chip shape itself tells you if the speed and feed are correct:



thin or powdery chips - increase the feed speed



loosely rolled chips - cutting values correct



thick, heavy of blue chips - cutting values too high

- ▶ In case of vibration, minimally adjust the cutting speed (m/min) up or down.
- ▶ As blunting increases, increase the feed rate slightly

Teeth arrangement recommendations for solid materials:

Variable toothing		
Material cross-section	Teeth per inch	
mm	tpi	Tooth shape
as of 550	0.75/1.25	K
380 - 750	1/1.5	K
250 - 550	1.4/2	K
120 - 350	2/3	K
80 - 140	3/4	K
60 - 110	4/6	K
40 - 70	5/7 5/8	K
30 - 60	6/10	K
20 - 40	8/11 8/12	K
up to 25	10/14	K

K = combined tooth

Teeth arrangement recommendations for pipes:

Thin-walled sections (0° rake angle)							
Wall thickness (S) in mm	Section external diameter (D) in mm						
	20	40	60	80	100	120	150
2	14	14	14	14	14	14	10/14
3	14	14	14	14	10/14	10/14	8/11 8/12
4	14	14	10/14	10/14	8/11 8/12	8/11 8/12	6/10
5	14	10/14	10/14	8/11 8/12	8/11 8/12	6/10	6/10
6	14	10/14	8/11 8/12	8/11 8/12	6/10	6/10	5/7 5/8
8	14	8/11 8/12	6/10	6/10	5/7 5/8	5/7 5/8	5/7 5/8
10	-	6/10	6/10	5/7 5/8	5/7 5/8	5/7 5/8	-

N = Standard tooth

H = Hook tooth

Combined teeth layouts 1,4/2, 2/3, 3/4, 4/5, 4/6 with 10° rake angle: these tooth shapes are particularly well suited to cutting solid, high-alloyed, long-chipping steel grade materials;

The use of 3/4 tooth layout allows for a good, clean cut surface in the upper Ø range up to 140 mm material cross-section.

Saw band geometry

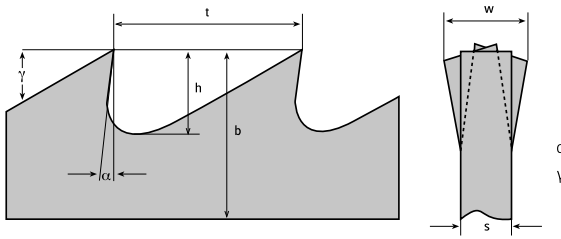

Teeth per inch

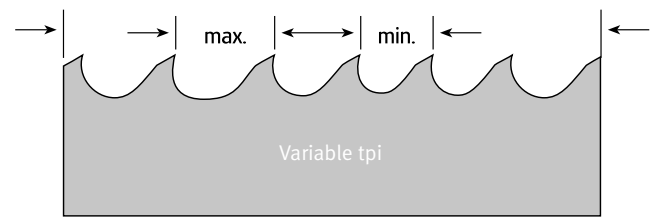

The distances between teeth change in a tooth group. Combined toothing of the saw band is designated by reference to the largest or smallest tooth in the tooth group.

Bi-metal

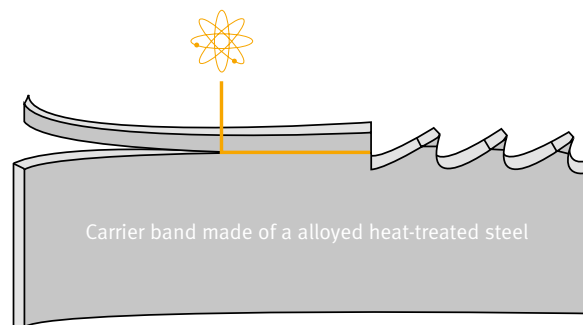

So flexible:

The carrier band on the bi-metal saw band consists of a specially alloyed heat-treated steel. Highly flexible with a strength of approx. 50 HRC. Long fatigue life and excellent in terms of the band run, this is an optimal basis.

Tough and resilient:

Tooth tips made of heat-treated HSS steel, M42 and M51 grades, guarantee maximum wear resistance thanks to mature heat treatment techniques and a defined structural state.

Optimally joined:

The carrier band and the HSS flat wire are optimally and immutably joined by electron or laser beam welding.

All the benefits:

The premium bi-metal saw band combines the flexibility of the carrier with the enormous wear resistance of HSS high speed steel. Each tooth tip of the finished saw band consists of heat-treated HSS steel, tough, resilient to load and with great performance.

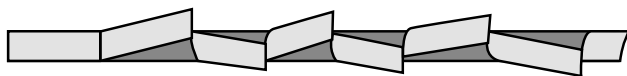

In addition to the tooth shape and tpi, the exact set of the saw band is definitive for its performance. An application-specific set guarantees correct cutting by the saw band. It prevents the band jamming - which is important for difficult steels. The set type and width is precisely matched to the cutting task:

Tooth shapes

Only the right choice of tooth shape optimally cuts your material with low vibration. There are various basic types here:

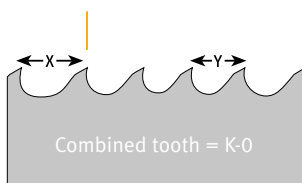

Specialist for:

- ▶ long-chipping, tough materials
- ▶ large cross-sections

Data:

- ▶ positive rake angle
- ▶ 2 to 6 TPI

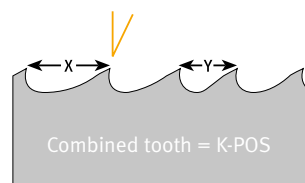

Specialist for:

- ▶ low-vibration cutting
- ▶ Profiles

Data:

- ▶ Rake angle of 0°
- ▶ variable TPI from 3/4 to 10/14 TPI

We are always happy to perform sample cutting for your special material.
Call us for details!

Saw bands

M42 Sprint saw bands

The section expert for small to medium wall thicknesses

Dimensions	Variable tooth groups					
mm	3/4	4/6	5/8	6/10	8/12	10/14
6 x 0.90						K
10 x 0.90						K
13 x 0.65			K	K	K	K
13 x 0.90				K	K	K
20 x 0.90		K	K	K	K	K
27 x 0.90	K	K	K	K	K	K
34 x 1.10	K	K	K	K	K	K
41 x 1.30	K	K	K	K		
54 x 1.60		K*	K*			

K = combined tooth *Special article

The combined with a 0° rake angle in combination with the group set will cut thin-walled sections with little vibration. Short-chipping material is processed with ease. The M42-SPRINT bi-metal saw band improves the service life and achieves good cutting quality.

The specialist for:

- ▶ popular steel grades up to approx. 1 400 N/mm² tensile strength
- ▶ NE sections
- ▶ Individual and bundle cuts
- ▶ Sections with low or medium wall thickness
- ▶ Steel sheets on vertical plate sawing systems

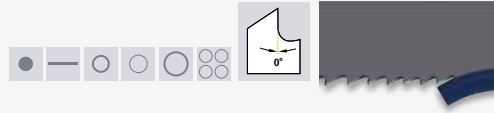

M42 Sprint Plus saw bands

Powerful for materials with medium to large dimensions

Dimensions	Variable tooth groups				
mm	0.75/1.25	1.4/2	2/3	3/4	4/6
20 x 0.90					K
27 x 0.90			K	K	K
34 x 1.10		K	K	K	K
41 x 1.30		K	K	K	K
54 x 1.30		K	K	K	K
54 x 1.60	K	K	K	K	K
67 x 1.60	K	K	K		
80 x 1.60	K	K			

K = combined tooth *Special article

The combined tooth with a positive rake angle in combination with the group set will cut solid material and thick-walled sections with little vibration, while improving the cutting performance and achieving a smooth surface.

The specialist for:

- ▶ popular steel grades up to approx. 1 400 N/mm² tensile strength
- ▶ NE sections
- ▶ Individual and bundle cuts
- ▶ Medium to large sized workpieces
- ▶ Thick-walled sections

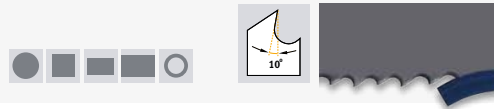

M42 Sprint Medium VS saw bands

The multifunctional talent for many cutting tasks

Dimensions	Variable tooth groups				
mm	2/3	3/4	4/6	5/7	8/11
20 x 0.90					K-V
27 x 0.90		K-V	K-V	K-V	K-V
34 x 1.10	K-V	K-V	K-V	K-V	
41 x 1.30	K-V	K-V	K-V		
54 x 1.30		K-V			
54 x 1.60	K-V	K-V	K-V		
67 x 1.60	K-V	K-V			

K-V = reinforced combined tooth

The new reinforced HL combined tooth with a positive rake angle in combination with the group set will cut solid material and thick-walled sections with very little vibration, while improving the cutting performance, achieving a smooth surface and an impressive service life.

The specialist for:

- ▶ small to medium-sized swivel frame machines
- ▶ popular steel grades up to approx. 1 400 N/mm² tensile strength
- ▶ Individual and bundle cuts
- ▶ Sections and beams
- ▶ Solid material

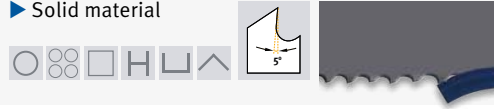

M42-X-FIT saw bands

The all rounder for small to medium-sized workpieces

Dimensions	Variable tooth groups				
mm	2/3	3/4	4/6	5/7	8/11
20 x 0.90					K-V
27 x 0.90		K-X	K-X	K-V	K-V
34 x 1.10	K-V	K-X	K-X	K-V	
41 x 1.30	K-X C-TEC	K-V C-TEC	K-X		
54 x 1.30		K-X			
54 x 1.60	K-X C-TEC	K-X C-TEC			
67 x 1.60	K-X C-TEC	K-X C-TEC			

K-X = reinforced, aggressive combined tooth
K-V = reinforced combined tooth

- ▶ The all-purpose band
- ▶ Specially developed tooth shape
- ▶ For processing a particularly large range of materials
- ▶ Universal deployment for solid material and sections
- ▶ Economical
- ▶ Reduces stock levels
- ▶ The specialist for solid material and sections

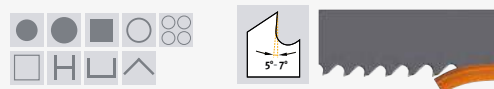

M51 Sprint Plus saw bands

Extra wear resistant teeth for steels and alloys of medium dimensions

Dimensions	Variable tooth groups		
mm	2/3	3/4	4/6
27 x 0.90	K	K	K
34 x 1.10	K	K	K
41 x 1.30	K	K	
54 x 1.60	K		
67 x 1.60	K		

K = combined tooth *Special article

The combined with an extremely positive rake angle in combination with the group set will cut thin-walled sections with little vibration. Tooth tips made of HSS M 51 additionally improve the band service life, in particular for problematic materials.

The specialist for:

- ▶ popular steel grades up to approx. 1 700 N/mm² tensile strength
- ▶ Corrosion and acid-resistant steels
- ▶ Nickel based alloys
- ▶ Titanium and special bronzes
- ▶ Solid material medium dimensions
- ▶ Thick-walled sections

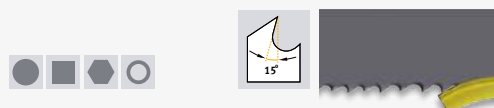

Saw bands for all Metalkraft metal band saws



Quality Made in Germany

Saw bands for metal-cutting band saws	Art. no.	€ plus VA	Saw bands for metal-cutting band saws	Art. no.	€ plus VAT	Saw bands for metal-cutting band saws	Art. no.	€ plus VAT
VMBS 1408 (bi-metal M 42)			BMBS 220 x 250			BMBS 300 x 320		
2 880 x 10 x 0.9 mm 10-14 Vario	3651110		2 450 x 27 x 0.9 mm 5-8 TPI	3655122		3 660 x 27 x 0.9 mm 5-8 TPI	3656301	
2 880 x 13 x 0.65 mm 6-10 Vario	3651210		2 450 x 27 x 0.9 mm 6-10 TPI	3655127		3 660 x 27 x 0.9 mm 6-10 TPI	3656302	
2 880 x 13 x 0.65 mm 8-12 Vario	3651212		2 450 x 27 x 0.9 mm 10-14 TPI	3655123		3 660 x 27 x 0.9 mm 10-14 TPI	3656303	
2 880 x 13 x 0.65 mm 10-14 Vario	3651214		2 450 x 27 x 0.9 mm 3-4 TPI	3655120		3 660 x 27 x 0.9 mm 3-4 TPI	3656304	
VMBS 1610 / VMBS 1610 E (bi-metal M 42)			2 450 x 27 x 0.9 mm 2-3 TPI	3655121		3 660 x 27 x 0.9 mm 2-3 TPI	3656305	
3 140 x 13 x 0.65 mm 6-10 Vario	3651310		2 450 x 27 x 0.9 mm 4-6 TPI	3655119		3 660 x 27 x 0.9 mm 4-6 TPI	3656306	
3 140 x 13 x 0.65 mm 8-12 Vario	3651312		2 450 x 27 x 0.9 mm 3-4 TPI	3655125		3 660 x 27 x 0.9 mm 2-3 TPI	3656307	
3 140 x 13 x 0.65 mm 10-14 Vario	3651314		2 450 x 27 x 0.9 mm 2-3 TPI	3655126		3 660 x 27 x 0.9 mm 3-4 TPI	3656308	
VMBS 2012 / VMBS 2012 E (bi-metal M 42)			2 450 x 27 x 0.9 mm 3-4 TPI (PU 5)	3655800		3 660 x 27 x 0.9 mm 4-6 TPI	3656309	
4 030 x 13 x 0.65 mm 6-10 Vario	3651710		2 450 x 27 x 0.9 mm 4-6 TPI (PU 5)	3655801		3 660 x 27 x 0.9 mm 3-4 TPI (PU 5)	3655815	
4 030 x 13 x 0.65 mm 8-12 Vario	3651712		BMBS 230 x 280			3 660 x 27 x 0.9 mm 4-6 TPI (PU 5)	3655816	
4 030 x 13 x 0.65 mm 10-14 Vario	3651714		2 720 x 27 x 0.9 5-8 TPI	3655508		BMBS 360 x 500 / HMBS 340		
			2 720 x 27 x 0.9 6-10 TPI	3655510		4 780 x 34 x 1.1 mm 5-8 TPI	3655403	
			2 720 x 27 x 0.9 10-14 TPI	3655514		4 780 x 34 x 1.1 mm 6-10 TPI	3655405	
4 030 x 20 x 0.9 mm 6-10 Vario	3651720		2 720 x 27 x 0.9 2-3 TPI	3655603		4 780 x 34 x 1.1 mm 2-3 TPI	3655400	
4 030 x 20 x 0.9 mm 8-12 Vario	3651722		2 720 x 27 x 0.9 3-4 TPI	3655604		4 780 x 34 x 1.1 mm 3-4 TPI	3655401	
4 030 x 20 x 0.9 mm 10-14 Vario	3651724		2 720 x 27 x 0.9 4-6 TPI	3655606		4 780 x 34 x 1.1 mm 4-6 TPI	3655402	
			2 720 x 27 x 0.9 2-3 TPI	3655703		4 780 x 34 x 1.1 mm 3-4 TPI (PU 5)	3655825	
4 030 x 27 x 0.9 mm 6-10 Vario	3651730		2 720 x 27 x 0.9 3-4 TPI	3655704		4 780 x 34 x 1.1 mm 4-6 TPI (PU 5)	3655826	
4 030 x 27 x 0.9 mm 8-12 Vario	3651732		2 720 x 27 x 0.9 4-6 TPI	3655706		BMBS 460 x 600		
4 030 x 27 x 0.9 mm 10-14 Vario	3651734		2 720 x 27 x 0.9 mm 3-4 TPI (PU 5)	3655805		5 380 x 41 x 1.3 mm 3-4 TPI	3655230	
VMBS 2613 / VMBS 2613 E (bi-metal M 42)			2 720 x 27 x 0.9 mm 4-6 TPI (PU 5)	3655806		5 380 x 41 x 1.3 mm 2-3 TPI	3655231	
4 680 x 13 x 0.65 mm 6-10 Vario	3651810		BMBS 250 x 315			5 380 x 41 x 1.3 mm 4-6 TPI	3655232	
4 680 x 13 x 0.65 mm 8-12 Vario	3651812		2 825 x 27 x 0.9 mm 5-8 TPI	3655222		HMBS 350 x 400		
4 680 x 13 x 0.65 mm 10-14 Vario	3651814		2 825 x 27 x 0.9 mm 6-10 TPI	3655226		4 520 x 34 x 1.1 mm 5-8 TPI	3655201	
			2 825 x 27 x 0.9 mm 10-14 TPI	3655223		4 520 x 34 x 1.1 mm 6-10 TPI	3655218	
4 680 x 20 x 0.9 mm 6-10 Vario	3651820		2 825 x 27 x 0.9 mm 3-4 TPI	3655220		4 520 x 34 x 1.1 mm 3-4 TPI	3655001	
4 680 x 20 x 0.9 mm 8-12 Vario	3651822		2 825 x 27 x 0.9 mm 2-3 TPI	3655221		4 520 x 34 x 1.1 mm 2-3 TPI	3655101	
4 680 x 20 x 0.9 mm 10-14 Vario	3651824		2 825 x 27 x 0.9 mm 4-6 TPI	3655219		4 520 x 34 x 1.1 mm 3-4 TPI (PU 5)	3655820	
			2 825 x 27 x 0.9 mm 3-4 TPI	3655224		4 520 x 34 x 1.1 mm 4-6 TPI (PU 5)	3655821	
4 680 x 27 x 0.9 mm 6-10 Vario	3651830		2 825 x 27 x 0.9 mm 4-6 TPI	3655225		HMBS 400 x 400		
4 680 x 27 x 0.9 mm 8-12 Vario	3651832		2 825 x 27 x 0.9 mm 3-4 TPI (PU 5)	3655810		5 580 x 41 x 1.3 mm 3-4 TPI	3655600	
4 680 x 27 x 0.9 mm 10-14 Vario	3651834		2 825 x 27 x 0.9 mm 4-6 TPI (PU 5)	3655811		5 580 x 41 x 1.3 mm 2-3 TPI	3655601	
VMBS 3612 / VMBS 3612 E (bi-metal M 42)			BMBS 240 x 280			HMBS 300 x 300 & HMBS 400		
5 020 x 13 x 0.65 mm 6-10 Vario	3651910		2 980 x 27 x 0.9 mm 5-8 TPI	3655206		4 520 x 34 x 1.1 mm 2-3 TPI	3655520	
5 020 x 13 x 0.65 mm 8-12 Vario	3651912		2 980 x 27 x 0.9 mm 6-10 TPI	3655207		4 520 x 34 x 1.1 mm 3-4 TPI	3655521	
5 020 x 13 x 0.65 mm 10-14 Vario	3651914		2 980 x 27 x 0.9 mm 10-14 TPI	3655208		4 520 x 34 x 1.1 mm 4-6 TPI	3655522	
			2 980 x 27 x 0.9 mm 3-4 TPI	3655013		HMBS 500 x 750		
5 020 x 20 x 0.9 mm 6-10 Vario	3651920		2 980 x 27 x 0.9 mm 2-3 TPI	3655115		6 500 x 41 x 1.3 mm 5-8 TPI	3655242	
5 020 x 20 x 0.9 mm 8-12 Vario	3651922		2 980 x 27 x 0.9 mm 4-6 TPI	3655116		6 500 x 41 x 1.3 mm 2-3 TPI	3655240	
5 020 x 20 x 0.9 mm 10-14 Vario	3651924		2 980 x 27 x 0.9 mm 2-3 TPI	3655212		6 500 x 41 x 1.3 mm 3-4 TPI	3655241	
			2 980 x 27 x 0.9 mm 3-4 TPI	3655213		HMBS 510 x 510		
5 020 x 27 x 0.9 mm 6-10 Vario	3651930		2 980 x 27 x 0.9 mm 4-6 TPI	3655214		6 060 x 41 x 1.6 mm 3-4 TPI	3655007	
5 020 x 27 x 0.9 mm 8-12 Vario	3651932		BMBS 290 x 290 & BMBS 290 x 320			6 060 x 54 x 1.6 mm 2-3 TPI	3655107	
5 020 x 27 x 0.9 mm 10-14 Vario	3651934		3 100 x 27 x 0.9 mm 5-8 TPI	3655200		HMBS 700 x 750		
			3 100 x 27 x 0.9 mm 6-10 TPI	3655209		7 680 x 41 x 1.6 mm 3-4 TPI	3655410	
Saw bands for metal-cutting band saws	Art. no.	€ plus VAT	3 100 x 27 x 0.9 mm 10-14 TPI	3655204		7 680 x 67 x 1.6 mm 2-3 TPI	3655411	
MBS 105			3 100 x 27 x 0.9 mm 3-4 TPI	3655000		HMBS 850 x 1 000 & HVMS 850 x 1 000		
1 335 x 13 x 0.65 mm 6-10 TPI	3650011		3 100 x 27 x 0.9 mm 2-3 TPI	3655100		9 080 x 41 x 1.6 mm 3-4 TPI	3655011	
1 335 x 13 x 0.65 mm 10-14 TPI	3650012		3 100 x 27 x 0.9 mm 4-6 TPI	3655146		9 080 x 67 x 1.6 mm 2-3 TPI	3655111	
MBS 125			3 100 x 27 x 0.9 mm 2-3 TPI	3655227		HMBS 1 200 x 1 400, HVMS 1 200 x 1 600 Xtreme,		
1 440 x 13 x 0.65 mm 6-10 TPI	3650014		3 100 x 27 x 0.9 mm 3-4 TPI	3655228		11 650 x 80 x 1.6 mm 3-4 TPI	3655113	
1 440 x 13 x 0.65 mm 10-14 TPI	3650015		3 100 x 27 x 0.9 mm 4-6 TPI	3655229		11 650 x 80 x 1.6 mm 2-3 TPI	3655114	
MBS 150								
1 735 x 27 x 0.9 mm 6-10 TPI	3650017							
1 735 x 13 x 0.9 mm 10-14 TPI	3650018							
MBS 155								
1 735 x 27 x 0.9 mm 6-10 TPI	3650017							
1 735 x 13 x 0.9 mm 10-14 TPI	3650018							

- M42 Sprint saw bands
- M42 Sprint Plus saw bands
- M42 Sprint Medium VS saw bands
- M42-X-FIT saw bands
- M51 Sprint Plus saw bands

See left-hand side for explanations

Magnetic drilling
Deburring
Metal grinding
Cutting
Notching & punching
Bending
Presses
Circular saws
Roller conveyors
Cutting band saws