

WELCOME TO GEC ANDERSON

1962 witnessed the creation of GEC Anderson by Gulvie Elna Charlotta Anderson. She could not have predicted the impact she, and her modest company, would make in the world of made-to-measure stainless steel design and manufacture. During the following decades the simple beauty and creative applications of high quality Swedish stainless steel, championed by GEC Anderson, began to gain the appreciation of a loyal group of discerning architects, designers and end-users. More recently the quest for individuality has led to an explosion in the use of stainless steel in mainstream kitchen and bathroom design where appearance and ultra-hygienic conditions have become more important. This trend looks set to continue long into the future.

INTRINSIC QUALITIES INTRINSIC BENEFITS OPTIMUM RESULTS

This is no accident. Quality craftsmanship and finish, combined with the supreme and unique material properties of top-quality stainless steel, form the basis of every GEC Anderson product. A simple, attractive and timeless visual quality is effectively combined with the granting of a 'freedom to design' within carefully devised parameters. (You determine the exact worktop shape and size and can choose between integral edge-profiles of almost infinite variety and from our extensive range of sink bowl sizes and configurations). By capturing the imagination of the designer, GEC Anderson has succeeded in achieving ultimate end-results.

'The look and feel of the GEC Anderson worktop and sinktops are exactly what we were looking for. We have tried other stainless steel suppliers. None have been able to match either the quality of finish or the expert and reliable service that GEC Anderson deliver.'

*Nigel Green,
Trotman Green Partnership*

A CLASS OF IT'S OWN

Imagine made-to-measure worktops that are designed to fit the exact space available – without joins or seams; that include integrated sinks – with no joins or crevices; that are totally hygienic and aseptic; that can withstand hot pans and cutting directly onto their surface; that look stunning and are virtually maintenance-free.

No other material can provide all of these benefits, yet GEC Anderson stainless steel products do.

PROFESSIONAL, COMPREHENSIVE AND RELIABLE SUPPORT

GEC Anderson is committed to producing the highest quality products, backed by service that is second to none.

In striving for excellence, we aim to simplify and ease the procurement process and take pride in providing help and assistance at each project stage. From concept, planning and design – to specification and costing – to taking of dimensions and ordering – to delivery, installation and on-site assistance.

Please see inside back page for our full list of services.



Gulvie Tye unmask some early stainless steel sinktops destined for the Barbican Estate in London. Architects, Chamberlin Powell & Bon were seeking ultimate efficiency and space-saving. A place where space for a kitchen was most at a premium was on board a boat, so yacht designers, Brooke Marine, were brought in and GEC Anderson were able to meet their specification precisely.

CONTENTS

- 1 Product Groups
- 2 Applications – Spaces
- 5 Applications – Places
- 6 Stainless Steel
- 7 Production
- 8 Why choose stainless steel products from GEC Anderson?

Product Specification Data Inserts

MADE-TO-MEASURE

Stainless steel sinks, worktops, cabinets, panels, doors & shelving

SANITARYWARE

A comprehensive range of safe and highly durable stainless steel sanitary appliances

DECIMETRIC®

The professional quality, modular kitchen furniture system

PRODUCT GROUPS

GEC Anderson specialise exclusively in stainless steel products. Standard, modular and custom options enable us to accurately match products with individual budgets, timescales and specific end-user performance requirements.



MADE-TO-MEASURE

- Worktops
- Sinks
- Cabinets
- Panels & Doors
- Shelving

Made to your precise individual dimensions and requirements



SANITARYWARE

- WCs
- Urinals
- Wash Troughs
- Basins
- Drinking Fountains
- Mirrors
- Baths
- Sluice Sinks
- Sand Traps
- Bins
- Cleaners' Sink
- StorTidy Shelving

A comprehensive range of safe and highly durable sanitary appliances



DECIMETRIC®

- Sinks
- Worktops
- Cabinets
- Stands
- Shelving

The highly versatile and economic, modular kitchen furniture system featuring strong and hygienic professional quality

FURTHER INFORMATION

Please refer to **Product Specification Data** at back, visit www.gecanderson.co.uk or please ask!

APPLICATIONS – SPACES

GEC Anderson stainless steel products have effectively and successfully been deployed in many and varied building types, sectors and environments. Working closely with our clients, exacting solutions that meet with specific and individual user requirements are achieved. GEC Anderson products are specified by world-renowned architects and designers as well as many major property owners. Our clients range from national and multinational organisations to end-user individuals.

As a key building industry supplier, GEC Anderson greatly enjoys working with end-users as well as with architects, designers, consultants, contractors, kitchen and bathroom specialists, builder's merchants and OEM organisations.

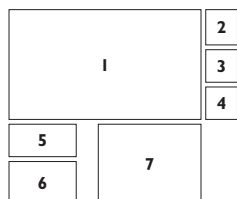

- 1 Domestic kitchen
- 2 Office tea point
- 3 Ward kitchen
- 4 Public convenience
- 5 Showroom
- 6 Classroom
- 7 Washroom

KITCHENS

- Domestic
- Commercial
- Kitchenettes
- Mess Rooms
- Tea Points
- Communal Areas
- Serveries

MEDICAL

- Consulting Rooms
- Surgeries
- Endoscopy Suites
- Sluice Rooms
- Operating Theatres

SPECIALIST

- Holding Cells
- Process Plants
- Play Areas
- Laboratories
- Studios
- Class Rooms

SANITATION

- Washrooms
- Changing Facilities
- Janitorial Areas





'I hadn't used stainless steel so extensively in a kitchen design before, so I asked a number of architect and design colleagues who they would recommend as a supplier. The unanimous response was GEC Anderson, and I'm very pleased to say that the end result looks as fabulous as I had hoped.'

Sebastian Rogers, Rogers & Co

'Stainless steel is an excellent choice for worktops because its seamless finish virtually eliminates the risk of leaks affecting storage or appliances. We approached GEC Anderson for the worktops as we had worked with them on several previous commissions. They offer a wide choice of edge details and upstands and can be relied on for seamless joins and a perfect fit.'

*Matthew King,
Woodbury Furniture Company*





APPLICATIONS – PLACES

Examples of GEC Anderson products are to be found in most sectors of social and economic activity.

HEALTH

GEC Anderson have supplied literally hundreds of hospitals, medical and care clinics and related environments, over several decades. The combined requirement for complete cleanliness, real durability and good ergonomics make high quality stainless steel units the obvious choice. Their professional and attractive appearance speaks for itself.

EDUCATION

GEC Anderson have always scored well within public and private sector education. From nurseries, pre-schools, primary and secondary schools to further and higher education establishments including several of our most revered colleges and universities.

TRANSPORT

GEC Anderson products have been used extensively in various transport environments including underground and overground rail infrastructure and rolling-stock projects for London Underground and the St Pancras Eurostar terminal. Airport projects, include London's Heathrow Terminal 5.

INDUSTRY AND COMMERCE

Projects undertaken by GEC Anderson include: offices, factories and retail spaces for many household names such as BT, Sony, Orange, Virgin, John Lewis, Seagram, Prudential, Baring Brothers, Glaxo and Bank of England.

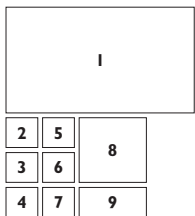

- 1 Lock Keeper's Cottage, Queen Mary University of London
- 2 Surrey Police HQ
- 3 Boardroom sinktops, London
- 4 Llwynrwy Primary School
- 5 Endoscopy Department
- 6 St Batholomew's Hospital
- 7 Heathrow Terminal 5
- 8 Bernard Leach Pottery Studio
- 9 Wembley Park Underground Station

Operating Theatre Ancillary Rooms, Birmingham Heartlands Hospital

'The operating theatres are in constant use, every day and we cannot afford to close them for repairs. The units must, therefore, be exceedingly durable. The staff who used these units have been so impressed that further units have since been installed.'

Pat Hayes, Estates Office

Heathrow Terminal 5

'For us it was a design-led choice. GEC Anderson offered the bespoke production that we needed and the ability to manufacture the required quantity within a short timeframe.'

Kay Greetham, BAA Design Manager for Terminal 5

Spike Island, Bristol

'When it came to specifying the big washing out sinks, we needed something reliable that would still clean up and look good after the artists had poured plaster, paint and various chemicals over them. We have used GEC Anderson products on several other projects and they are our default supplier for stainless steel. We are impressed by the quality of their products as well as their design detailing.'

Rod Heyes, Caruso St John

Emberton Park

'GEC Anderson were able to custom make the sinktop in a very short time. The other big advantage of the Decimetric® product is that its 100mm modular size increments permit specification of the largest possible unit to fit a space, without the premium of a true bespoke installation.'

Robert Gritton, Project Manager, Milton Keynes Council, Construction Services Department

SCIENCE

Included amongst the many scientific and laboratory projects undertaken by GEC Anderson, are The Royal Observatory, Greenwich and The British Antarctic Survey, South Pole.

LEISURE

Various theatres, galleries, museums, libraries, museums, hotels, restaurants, bars, clubs, recreation grounds have been supplied by GEC Anderson. Notably, Glyndebourne Opera House, Victoria & Albert Museum, New British Library, The Photographer's Gallery and London's Grosvenor House Hotel.

RESIDENTIAL

A large proportion of GEC Anderson sinks and worktops are produced for domestic use in both private and public sector accommodation including larger schemes such as the Barbican Centre and New Providence Wharf in London's docklands.

FACILITIES AND AMENITIES

Central and local government services, military and emergency services – fire, ambulance, police – that also encompass civic, communal, justice and custodial areas.



THIS IS STAINLESS STEEL

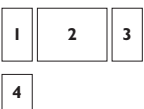

- 1 Brushed satin stainless steel
- 2 Textured stainless steel
- 3 Patina stainless steel
- 4 Early photograph of Zorn's stainless steel sinktop*

Stainless steel is the common name given to the family of alloys containing steel* with a minimum chromium content of 12%. A chromium-rich, 'passive' oxide film forms on the surface providing stainless steel with its unique anti-corrosive properties. This protective film will constantly 'repair itself' for example, when stainless steel is cut. The grade of stainless steel generally used in kitchens and bathrooms also contains at least 8% nickel and is known as austenitic stainless steel. The addition of nickel allows the stainless steel to become more ductile making it easy to work and form. Where higher resistance to corrosion is required (for example in laboratories), molybdenum is added to form the so-called acid resisting grades.

HISTORY AND CONTROVERSY

Stainless steel is said to have been discovered, by accident, in Europe. The Frenchman, LN Vauquelin had discovered Chromium in 1797 but it was not until circa 1900 that the benefits of adding Chromium to Iron were realised. Henry Brearly is widely accredited with discovering stainless steel (for use in gun barrels), Sheffield, 1912. However, Benno Strauss and Eduard Maurer, for Krupps of Germany, may have created a version of stainless steel already in 1909. Yet before this, the renowned Swedish artist, Anders Zorn (1860-1943) had brought an early version of the stainless steel sink home with him from USA. The sink is displayed to this day at Zornhuset, Dalarna, Sweden.



BRUSHED SATIN FINISH

Surface finish selection should balance appearance with required performance of the product in question. Various finishing methods are available but wet or dry mechanical polishing is used for most sheet stainless steels. Average 'roughness' of finish (Ra) critically determines the suitability of the material for its intended purpose. GEC Anderson's brushed satin stainless steel is achieved through a dry-polishing process resulting in a greater Ra value than is commonly used. The result is a more practical and easily maintained surface with a greater resistance to marking and scratching. A lustre and shine distinguishes it from so-called 'dull-polished' finishes (that are more coarsely grained) but neither is it highly polished (which is more susceptible to marking and, therefore, highly impractical).

TEXTURED FINISH

The raised pattern of textured stainless steel facilitates drainage, resists damage, smudges and scratches. Textured finish applies to the entire worksurface (not bowls) with a maximum size of 2400 x 1150mm. Textured finish is not available for L-shaped or U-shaped worktops.

PATINA FINISH

GEC Anderson 'Patina' finish features a random micro-brushed pattern with matt appearance. It is less susceptible to finger marks, scratching and general signs of wear and tear. Patina finish applies to the worksurface and bowls.

GAUGE AND GRADE OF STAINLESS STEEL

Generally, the selection of gauge (1, 1.25, 1.5 or 2mm) is left to the expertise of our factory, depending on the size and nature of the product being manufactured.

'Domestic grade' (EN 1.4301, also known as 18/8 or AISI 304 grade or SIS2333) is used in most products. For equipment destined for use in laboratories and certain special environments, 'acid-resisting grade' (EN 1.4401, also known as 18/12 or AISI 316/319 or SIS2343) is used.

SUSTAINABILITY

- ♻️ Stainless steel is 100% recyclable
- Stainless steel is in abundant supply
- 60% of UK steel is recycled (due to high scrap values) – equivalent to 180 Eiffel Towers each day†
- Stainless steel products are capable of lasting for decades, resulting in great efficiency and very low whole-life costs
- GEC Anderson advocate chemical-free E-cloth® cleaning of stainless steel

* Iron with less than 2% Carbon provides Steel. Iron with more than 2% Carbon provides Cast Iron.

† Source CORUS

• Care of Sweden's Museum of Water, Ventilation and Sanitation, Katrineholm.

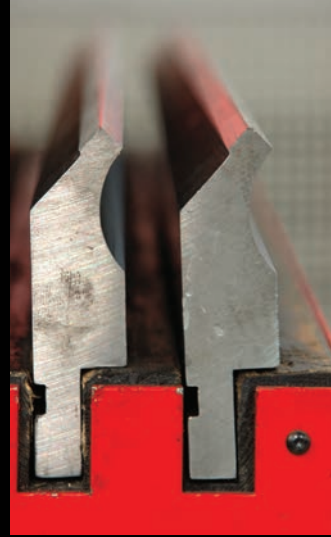
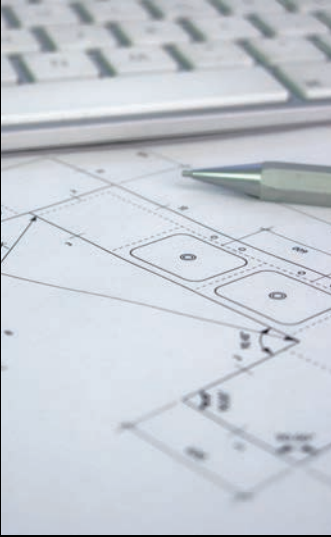

PRODUCTION

Production of GEC Anderson stainless steel products occurs within a strictly controlled, ISO 9001, state-of-the-art, highly efficient and automated manufacturing environment that also includes a special blend of traditional skills and craftsmanship.

- 1 Drawings** Accurate and agreed pre-production CAD drawings are crucial.
- 2 Cutting** Rapid and precise cutting of material is achieved through automated laser and punch technology.
- 3 Folding** Edges and other details are accurately press-formed.
- 4 & 5 Welding** A combination of fully-automated seam and manual welding techniques are deployed.
- 6 Polishing** A uniform, brushed satin finish is applied.
- 7 Substrate** A waterproof board substrate is bonded to worktops for strength, rigidity and ease of fixing.
- 8 Quality** Cleaning and final inspection form part of strict quality controls.



1	2	3	4
5			
6	7	8	

WHY CHOOSE STAINLESS STEEL PRODUCTS FROM GEC ANDERSON?

GEC Anderson's traditions and roots stem from a close association with the kitchen, initially, through the provision of made-to-measure stainless steel worksurfaces. Since 1962, our range has evolved to include stainless steel cabinets, shelving, panels and splashbacks (as well as sanitaryware). During this period, we have gained a deep understanding of the significance and importance of the kitchen – both as 'the heart of the home' as well as within working environments. We have also learnt to appreciate some of the essential considerations necessary in furthering and enhancing kitchen design.

INDIVIDUALITY, FOR YOU

Whether designing for domestic kitchens, work refreshment zones, commercial kitchens or for other specialist applications, the individual needs and requirements of users should be paramount. GEC Anderson custom stainless steel solutions encourage self-expression of the individual. This flexibility, versatility and individuality helps to explain why GEC Anderson stainless steel products have found their way into such a breadth and variety of environments and applications whether domestic, commercial or institutional.

SEEKING THE OPTIMAL CHOICE

Discovering the optimal, long-term, solution for specific situations and circumstances requires effort and conscious choice. It is therefore important to choose – design, materials, workmanship – carefully. GEC Anderson products offer long-term and enduring solutions with added peace of mind. Their physical durability is clearly a factor but so too are their classic, clean, simple and timeless visual qualities that put them beyond fashions, trends and class. This extended design-life is reflected through low lifetime costs.

THE FUTURE BELONGS TO STAINLESS STEEL

Currently, no serious alternative to stainless steel exists on grounds of hygiene, durability or versatility. None is foreseen. The inherent advantages of stainless steel products in kitchens and washrooms determines that the use of the material is set to grow. No other materials offer the pure, clean looks of stainless steel or its longevity. Typically, GEC Anderson stainless steel products have an extended life cycle of 50 years. Afterwards, stainless steel is 100% recyclable.

WE ARE WAITING TO HEAR FROM YOU

GEC Anderson have specialised in stainless steel products since 1962. We have a broad experience, gained from dealing with customers and projects in most economic sectors and environments and we look forward to demonstrating our firm commitment to helping and assisting you with your next project.

DESIGN POSSIBILITIES

We know that good kitchen design is concerned not only with visual performance – which, surely, is important. Physical performance considerations will typically include:

Space Available space can be maximised through bespoke, one-piece surfaces, with simple forms and no joins

Easy Living Achieve minimal cleaning and maintenance and exclude 'precious' or delicate elements and materials

Hygiene Aseptic, germ-free surfaces, with integrated sinks, edges and upstands and no joins or spaces for bacteria

Durability Solutions able to withstand years of sustained heavy use (and even abuse)

Economy Lifetime costs can be dramatically reduced with long-life elements requiring zero maintenance

Practicality Integral edge options to prevent spillage and surfaces that will withstand hot pans or direct chopping

Safety Shatterproof, fireproof, non-toxic, emission-free and virtual indestructibility

Honesty Emanating from products with no falsehood, veneer or superficiality

Versatility The suitability of materials, knowledge and designs to different applications and environments

Sustainability The quest for sustainable and environmentally defensible products, materials and suppliers.

In many instances, stainless steel provides the only meaningful choice for serious long-term use.

ORDERING

Standard products

Often available from stock. Simply provide product reference and quantity required.

Special products

Made to order.

- Please specify your requirements and/or refer to us for quotation and specification
- Upon receipt of order, we will issue our pre-production drawing to you, for approval
- A site visit will be arranged and dimensions and templates will be taken if GEC Anderson is installing for you
- As soon as your approval is obtained, your order will be placed into production
- We will confirm your order, in writing, to you with a confirmed delivery date
- Delivery, to the location of your choice, will be arranged and coordinated
- Installation will be pre-arranged where appropriate

Please indicate any delivery requirements or instructions.

Please ensure safe disposal of packaging.

For clarity and to minimise risk of errors, we ask for orders, in writing please.

INSTALLATION AND MAINTENANCE

Leave plastic surface protection in place until installation is complete. GEC Anderson recommends the E-cloth® system. Alternatively, wash with cold water and detergent. A fine scouring powder will remove persistent stains. Do not use coarse abrasive cleaners or bleach! Strong acids can mark and pit stainless steel.

We reserve the right to change the design or technical details without notice.

**COMPREHENSIVE,
PROFESSIONAL, FRIENDLY
AND EFFICIENT SUPPORT**

- **Technical advice and design guidance**
Available when you need it, regardless of project scale.
 - **Rapid product specification and quotation**
Assisting you with meeting deadlines and to safeguard specifications.
 - **Secure ordering procedures**
For added assurance and peace of mind.
 - **Pre-production CAD drawings**
For clarity, time-saving and added assurance.
 - **Dependable, on-time and co-ordinated deliveries**
Helping you to avoid costly delays and adhere to work-programs.
 - **Measuring and installation service**
Let us take care of it for you.
 - **Cleaning and maintenance guidance**
Full instructions and back up, including the E-cloth® system.
 - **Technical product literature**
Carefully designed for clarity and ease of reference.
 - **www.gecanderson.co.uk**
Comprehensive product data; case studies and examples; news items; specification clauses and CAD drawings.
- Please contact us if we can help you in any way!

Product Specification

Data is available for:

MADE-TO-MEASURE

Stainless steel sinks, worktops,
cabinets, panels, doors
& shelving

SANITARYWARE

WCs, urinals, basins, mirrors,
baths, sluice sinks, bins &
drinking fountains

DECIMETRIC®

Professional quality, modular
kitchen furniture system

*Please request further copies
as required.*

*'When trends and fashions fade,
we know that [our] stainless steel
will continue to shine for those
discerning users and specifiers
whom GEC Anderson has been
fortunate enough to serve over
the many years we have been
in business.'*

*Martin Tye, Managing Director,
GEC Anderson*

Some of GEC Anderson's clients include

NEW COLLEGE OXFORD BT HERTFORDSHIRE COUNTY COUNCIL NATIONAL GALLERY GUY'S HOSPITAL DRIESSEN SUFFOLK COUNTY COUNCIL ASDA NEW BRITISH LIBRARY BAA ROYAL ACADEMY BIRMINGHAM CHILDREN'S HOSPITAL ROYAL COLLEGE OF ART METROPOLITAN POLICE EMI GLYNDEBOURNE OPERA HOUSE HEART OF ENGLAND FOUNDATION NHS TRUST GLASGOW DISTRICT COUNCIL BP URBAN SPLASH SOUTH WALES FIRE AND RESCUE SERVICE PRUDENTIAL EALING BOROUGH COUNCIL EUROSTAR BRITISH RAIL SOMERSET HOUSE MANCHESTER MUSEUM UNITED STATES EMBASSY IN LONDON BMW FITZJOHNS PRIMARY SCHOOL LONDON UNDERGROUND BANK OF ENGLAND UNIVERSITY COLLEGE LONDON JOHN LEWIS PARTNERSHIP MILTON KEYNES NHS TRUST NORTHAMPTON BOROUGH COUNCIL CROMWELL HOSPITAL FANSHAW LIBRARY DAGENHAM BRITISH AIRWAYS SPIKE ISLAND CAMDEN COUNCIL COLLEGE OF NORTH EAST LONDON ROYAL NAVAL COLLEGE GREENWICH TATE GALLERY ST JOHN'S COLLEGE OXFORD ENGLISH HERITAGE KIRKALDY DISTRICT COUNCIL MADAME TUSSAUD CHESHIRE COUNTY COUNCIL RAF SONY ST JAMES HOMES NEWCASTLE PLAYHOUSE VIRGIN MAGDALEN COLLEGE OXFORD MANCHESTER CITY COUNCIL SEAGRAM HERTFORDSHIRE CONSTABULARY GSK VICTORIA & ALBERT MUSEUM IMPERIAL COLLEGE PHOTOGRAPHERS' GALLERY NEATH & PORT TALBOT DISTRICT COUNCIL CHALFORD STUDIOS RANK XEROX BUCKINGHAMSHIRE AND MILTON KEYNES FIRE AUTHORITY ROYAL FESTIVAL HALL TRINITY COLLEGE CAMBRIDGE WELCOME TRUST QUEEN MARY'S UNIVERSITY LONDON BRITISH TRANSPORT POLICE WAPPING CENTRE OF PERFORMING ARTS SURREY POLICE ENTERPRISE INNS UNIVERSITY OF EAST ANGLIA EVELINA CHILDREN'S HOSPITAL WALSALL ART GALLERY

'First class standard of workmanship and service from GEC Anderson. The units look stunning. They are almost works of art.'

Project Manager for Grosvenor House Hotel

Designed by www.kmdesign.co



GEC Anderson Limited Oakengrove Shire Lane Hastoe Tring Hertfordshire HP23 6LY
Tel +44 (0)1442 82 6999 Fax +44 (0)1442 82 5999 info@gecanderson.co.uk www.gecanderson.co.uk

FSC logo to be dropped
in here white out on
black background

SERIES A – INDIVIDUAL SINK BOWLS

Trade Prices



GEC ANDERSON SERIES A sink bowls are of the highest quality and are available in an unrivalled range of standard sizes and combinations. They are made from satin stainless steel (EN 1.4301).

Series A sink bowls feature the practical but minimal corner radius of 15mm.

The 20mm flat flange has a corner radius 10mm.

Combinations and doubles have 25mm partition.

Basket strainer waste (BSW) and overflow fittings are included.

Series A sink bowls are suitable for all installation options:

- Inset
- Undermount
- Flushmount

‘These sinks are really beautifully made and the range of available sizes is amazing’

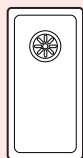

A18 (180 x 400 x 170)
(Overall size: 220 x 440)
£336 + VAT

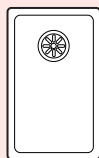

A23 (230 x 400 x 170)
(Overall size: 270 x 440)
£344 + VAT

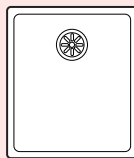

A34 (340 x 400 x 200)
(Overall size: 380 x 440)
£351 + VAT

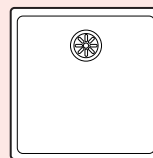

A40 (400 x 400 x 200)
(Overall size: 440 x 440)
£359 + VAT

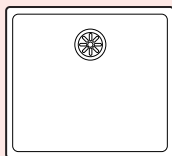

A45 (450 x 400 x 200)
(Overall size: 490 x 440)
£368 + VAT

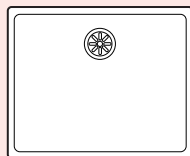

A50 (500 x 400 x 200)
(Overall size: 540 x 440)
£377 + VAT

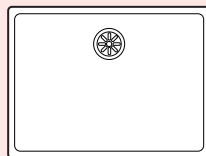

A55 (550 x 400 x 200)
(Overall size: 590 x 440)
£393 + VAT

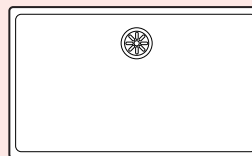

A70 (700 x 400 x 200)
(Overall size: 740 x 440)
£459 + VAT

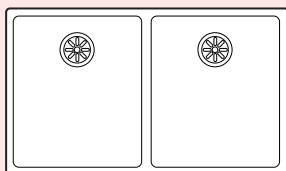

AD34 (A34 + A34)
(Overall size: 745 x 440)
£703 + VAT

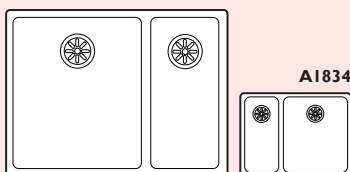
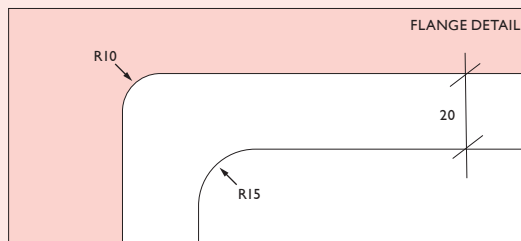

A3418 (A34 + A18)
(Overall size: 585 x 440)
£687 + VAT

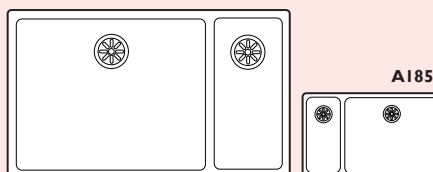

A5018 (A50 + A18)
(Overall size: 745 x 440)
£713 + VAT

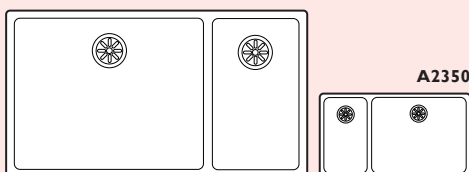

A5023 (A50 + A23)
(Overall size: 795 x 440)
£722 + VAT

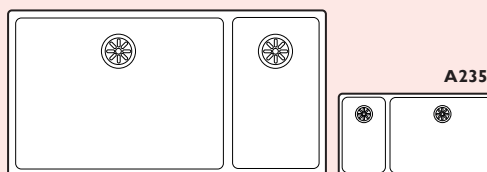

A5523 (A55 + A23)
(Overall size: 845 x 440)
£738 + VAT

All dimensions in millimetres

MADE-TO-MEASURE STAINLESS STEEL



- Sinks
- Worktops
- Cabinets
- Panels
- Doors
- Shelving

MADE-TO-MEASURE stainless steel sinks, worktops, cabinets, panels, doors and shelving are produced to meet your precise requirements and dimensions using GEC Anderson brushed satin finish stainless steel (EN 1.4301).

Options

- Textured finish stainless steel
- Patina finish stainless steel
- EN 1.4401 acid-resisting stainless steel



GEC Anderson worktops are MADE-TO-MEASURE in one continuous piece, to the exact shape and size prescribed and with NO JOINS at sink bowl(s), edges or upstands. Worktops are flat (not sloping or fluted) with 19mm bonded particleboard substrate, for strength, rigidity and ease of fixing. Installation is simple and rapid with no further work on site required. Simply screw fix from below.

- **Sink bowls** are positioned where required, in any combination or arrangement
- **Cut-outs** (eg. for tapholes, hobs, columns etc.) as required
- **Edge details** are specified by you depending on individual end-user needs and requirements
- **Maximum length:** 5 metres.
Maximum return for L-shapes and U-shapes: 2.3 metres
- **Maximum size for textured finish:** 2.4 x 1.15 metres

STAINLESS STEEL

- Legs** see page p6
- Cantilever Brackets** see page p6
- Base Cabinets** see page p7
- Doors** see page p7
- Splashbacks** see page p7

SINK BOWLS

Sink bowls are welded into worksurface – exactly where required and in any position or combination – with no joins.

Special sizes are also available.

Sink bowls can be supplied individually (eg. to inset or undermount).

When selecting sink bowls and combination units, please note:

- **Minimum distances/ spaces required:**
 - From any edge to bowl: 35mm (70mm when mounted on stainless steel legs)
 - Between two or more single bowls integrated into same worktop: 35mm
 - For tapholes: 80mm
- **Manufacturing tolerances:** ± 2mm
- **Bowl sizes:** provided as internal measurements excluding flange
- **Non-standard sizes available** to order
- **Depth:** Measured at deepest point by outlet. Bowls slope towards outlet
- **Outlets:**
 - **Standard:** Ø89mm with basket strainer waste (BSW) and overflow (except for T10, V211 and LR25: Ø38mm)
 - **Option:** Ø38mm plug-waste and overflow

KEY

10 12 14 20 30

Flange widths vary and are shown for inset bowls (type A) only
NB. IS11 and IS21 have self-rim edge

- ⊗ Overflow position
 - ⊗ Optional overflow
 - 🧪 Available in EN 1.4401 acid-resisting grade stainless steel
 - ⤴ Hemispherical bowl
- All dimensions in millimetres

FIXING OPTIONS FOR BOWLS SUPPLIED INDIVIDUALLY

Above surface

A or C – including fixing clamps

Below surface

B – no fixing clamps

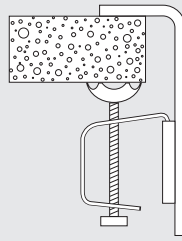

A Above surface (Inset or Flushmount)

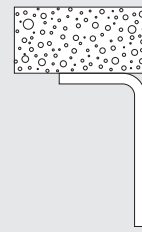

B Below surface (Undermount)

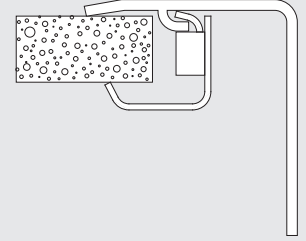

C Above surface (50mm bevelled flange)

SINGLE BOWLS

 LR25 (Ø250 x 125) 20	 LR31 (Ø313 x 150) 30	 V211 (Ø300 x 130) 20	 LR38 (Ø380 x 160) 30
 LE30 (300 x 344 x 175)	 LE34 (340 x 400 x 180) 14	 LE34S (340 x 400 x 180)	 LE35 (350 x 400 x 165)
 LE48 (480 x 400 x 180) 14	 LE48D (480 x 400 x 250)	 LE50 (500 x 400 x 200) 30	 BE50 (500 x 400 x 200) 30
 T29 (290 x 400 x 165)	 T22 (220 x 400 x 170)		
 T18 (180 x 380 x 160)	 LE18 (180 x 400 x 130) 12		
 T15 (150 x 344 x 120)	 T10 (100 x 250 x 125)		

EXAMPLE COMBINATIONS

 K30 (T15 + LE30)	 K34 (LE18 + LE34)
 K50B (T29 + BE50)	 K518A (T18 + LE50)
 K518B (T18 + BE50)	 LD34 (2 x LE34)
 LD50 (2 x LE50)	 BD50 (2 x BE50)

A SERIES

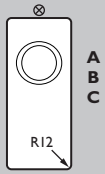

A17 (170 x 400 x 170) **20**

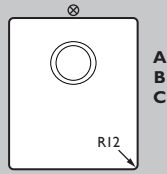

A34 (340 x 400 x 200) **20**

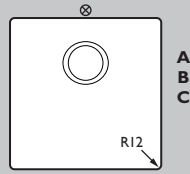

A40 (400 x 400 x 200) **20**

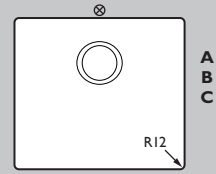

A45 (450 x 400 x 200) **20**

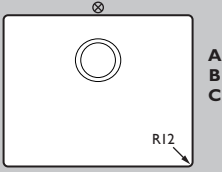

A50 (500 x 400 x 200) **20**

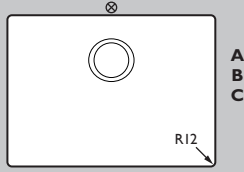

A55 (550 x 400 x 200) **20**

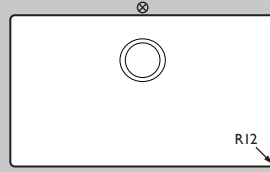

A70 (700 x 400 x 200) **20**

SUGGESTED DOUBLES AND COMBINATIONS (Slop sink available to left or right of main bowl)

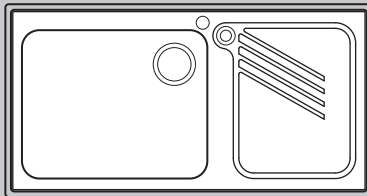

IS11L Bowl: 500 x 400 x 190
Drainer recess: 330 x 420
Overall: 945 x 470
(As inset: 985 x 510)
Partition: 60mm

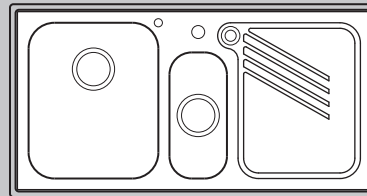
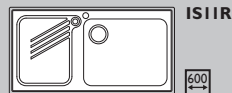

IS21L Bowls: 350 x 420 x 190
and 155 x 340 x 120
Drainer: 330 x 420 Overall: 945 x 470
(As inset: 985 x 510)
Partitions: 30mm

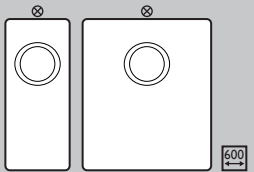
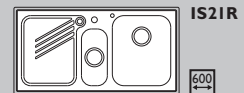

K1734 Bowl: 340 x 400 x 200
Slop sink: 170 x 400 x 170
Overall: 545 x 400
Partition: 35mm

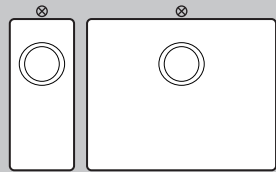

K1750 Bowl: 500 x 400 x 200
Slop sink: 170 x 400 x 170
Overall: 705 x 400
Partition: 35mm

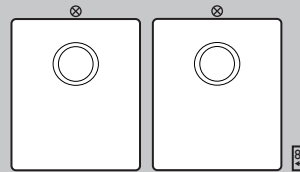

AD34 Bowl: 340 x 400 x 200 each
Overall: 715 x 400
Partition: 35mm

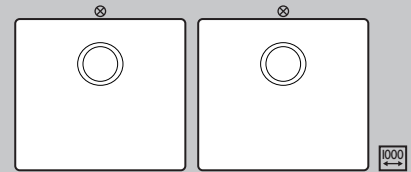

AD45 Bowl: 450 x 400 x 200 each
Overall: 935 x 400
Partition: 35mm

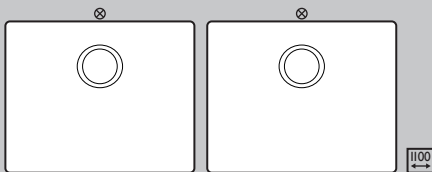

AD50 Bowl: 500 x 400 x 200 each
Overall: 1035 x 400
Partition: 35mm

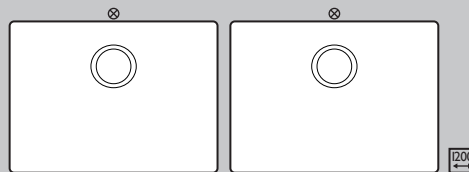

AD55 Bowl: 550 x 400 x 200 each
Overall: 1135 x 400
Partition: 35mm

WET ZONES

Lipped perimeter edges (edges 3, 2, 5 or 4) are recommended in wet areas. Alternatively, 'wet zones' can be created within worktops.













Shallow Recess (any size).
With or without fall.



Extended Edges (profiles 3 and 2) produce flat wet zone.

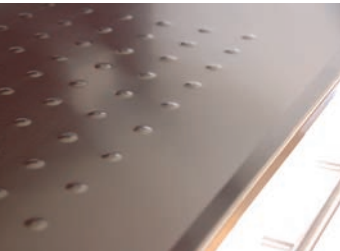

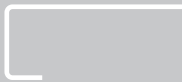
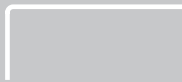
BOSS Raised pattern to facilitate drying, prevent scratching, withstand hot pans.



FRONT/SIDE	SIDE/BACK	BACK/SIDE	
Edge 3 (Standard height 30mm) 	Edge 2 (Standard height 30mm) 	Edge 1 	
Edge 5 (Standard height 25mm) 	Edge 4 (Standard height 25mm) 		
Edge 7 (Standard height 20mm) 	Edge 8 (Standard height 20mm) 	Edge 6 	

EDGE DETAILS



Edge details can be specified by you in various combinations, depending on individual end-user requirements and to ensure correct installation.

- Available as drawn (standard edges) or with varied dimensions (minimum 15mm, maximum height 100mm)
- 18mm waterproof particle-board core is standard. Increased board thickness available unless precluded by unit size or weight
- With stainless steel legs, add 20mm to standard worktop thickness

Other edges available, see website or contact us for further details.

UPSTAND		
Edge 10 (30-100mm high) 	Edge 10R (30-100mm high) 	

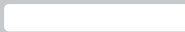
INSET	HTM63	
 <p>Special edge detail, with watersafe profile, to allow tops to be inset into other work-surface materials. Clamps supplied for fixing.</p>		

SOLIDTOP™		
	6.0mm solid stainless steel 	

All drawings scale 1:2 except HTM63 scale 1:4

PANELS AND SPLASHBACKS

PANELS AND SPLASHBACKS

GEC Anderson stainless steel panels and splashbacks are available in any size or shape and offer a durable, hygienic, easy to clean and attractive alternative eg. to tiles or painted finishes.

Stainless steel door and drawer-fronts are also available (see page 7).

- Folded edges (10, 13, 17 or 20mm) with waterproof particleboard backing
- Standard sheet sizes up to: 3 x 1.5 and 4 x 1 metres

Options

- Flat sheet available (backed or un-backed)
- Cut-outs (eg. for electrical points) are available as required



SHELVING SYSTEM

V90

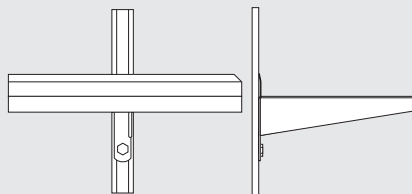
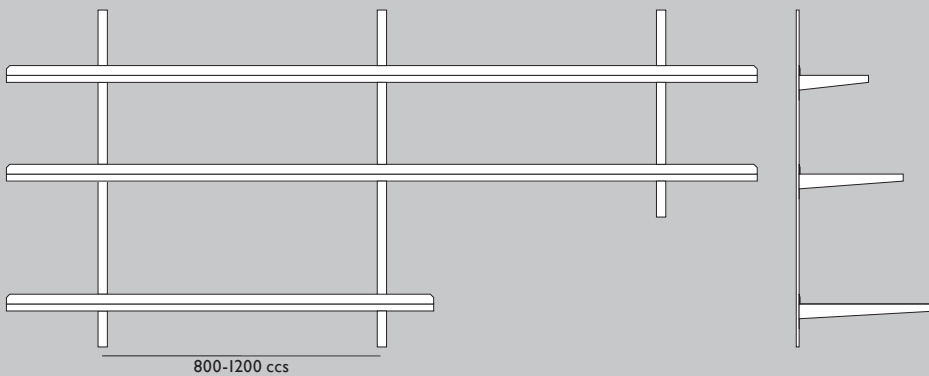

SHELVING

The unique GEC Anderson V90 shelving is a wall-fixed, 3-part stainless steel system providing versatile, flexible, attractive and hygienic open-storage suitable for many uses and environments. All components (shelves, uprights and brackets) are available individually and can be configured as required. Brackets locate to stepless and continuous (unslotted) uprights with a single clamp-screw. Shelves are solid.

- Maximum shelf length: 4.0 metres
- Standard shelf widths: 200, 300, 400, 500mm
- Uprights: 400, 600, 800, 1000, 1500, 1800, 2000mm. Recommended upright spacing: 800 – 1000mm
- StorTidy modules based on the V90 system are available in standard sets (see GEC Anderson Stainless Steel Sanitaryware)

Options

- Perforated shelves
- Barred shelf

LEGS

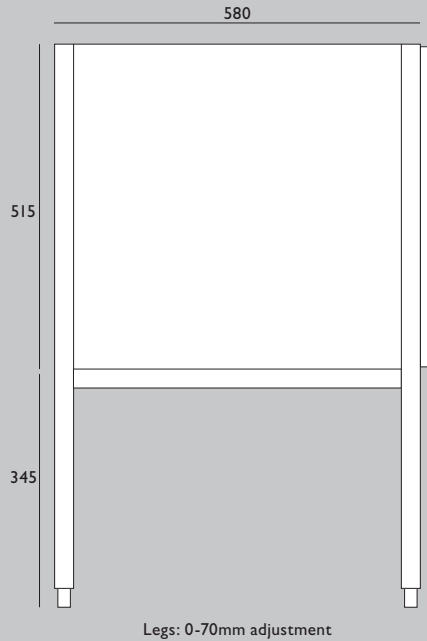

Legs: 0-70mm adjustment



LEGS

GEC Anderson stainless steel legs provide high weight capacity, durable and practical free-standing stainless steel worktops. They can also be supplied on their own (eg. for other worktop materials).

- 30 x 30mm square-section tubular brushed satin stainless steel legs
- Ø8mm barred shelf with 25 x 25mm perimeter frame
- 0 – 70mm manually adjustable plastic feet

Options

- Solid shelf
- No shelf
- Multiple shelves
- Chrome-plated feet (eg. for high fire-risk areas)
- Motorised, hydraulic adjustment system (+ - 300mm) for rapid and reliable multi-height units
- Braked castors (zinc-coated steel: Ø125mm rubber tyre. Overall height: 160mm)
- Special fixings (eg. floor-fixing plates) and clearances (eg. for pipework) on request

CANTILEVER BRACKETS

GEC Anderson stainless steel cantilever brackets provide medium weight capacity wall-mounted support to surfaces. Uninterrupted floor access eg. for cleaning and flexible storage spaces is a clear benefit when compared to free-standing units.

- 30 x 30mm square section tubular brushed satin stainless steel with 20 x 20mm cross brace
- Recommended spacing: 800 – 1000mm

Option

- Lower shelf prong

CANTILEVER BRACKETS



V21

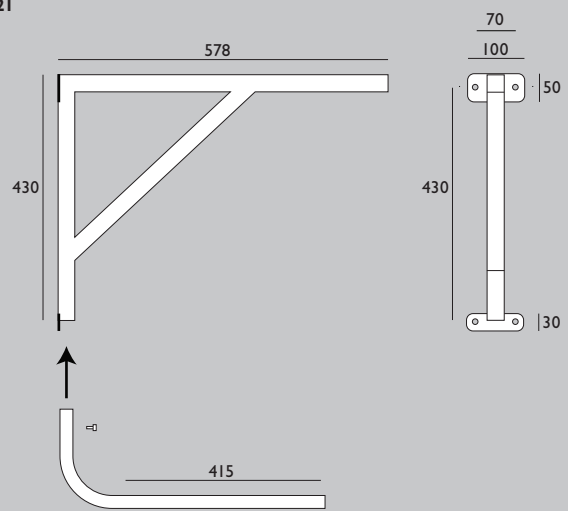

V22 (with optional undershelf support)

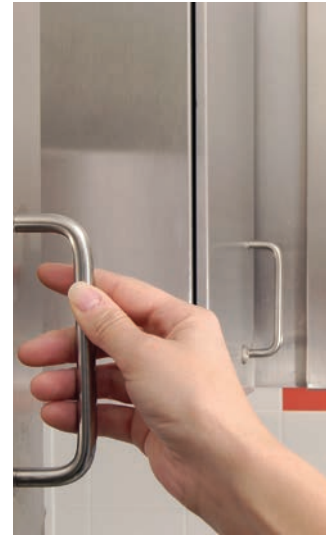
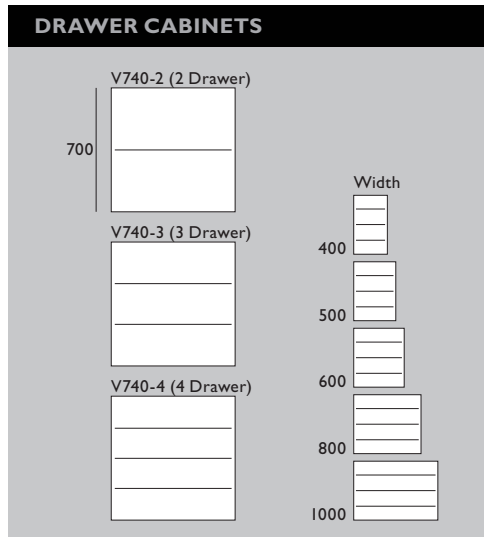
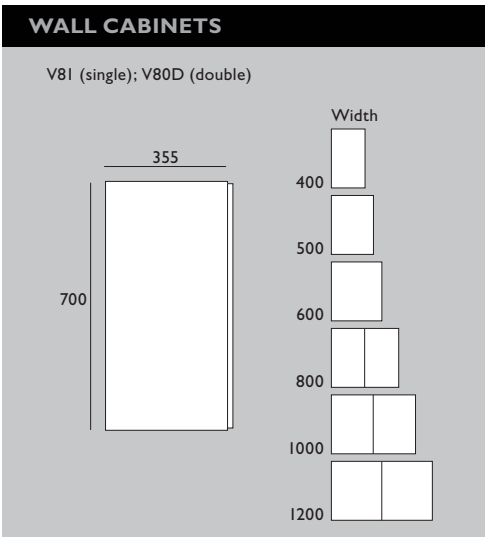
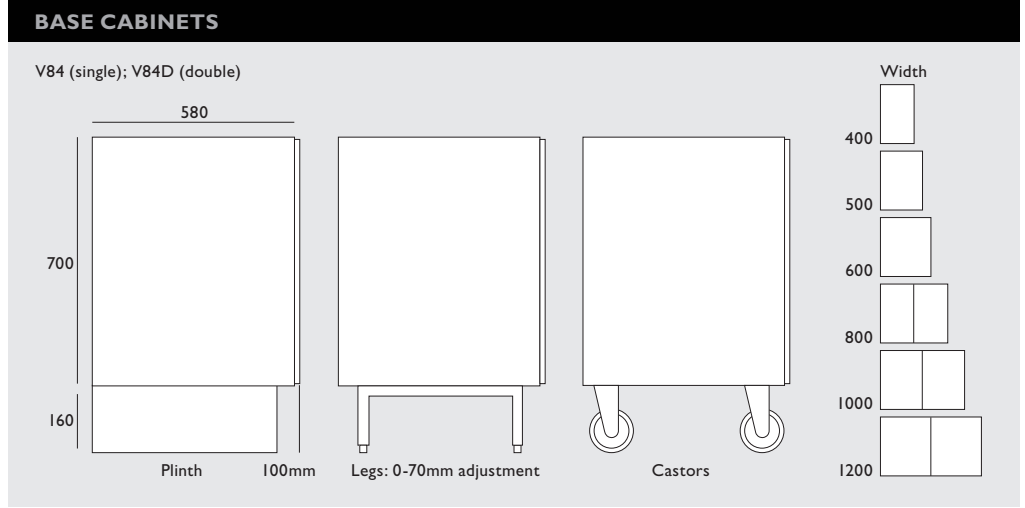

CABINETS

GEC Anderson stainless steel base cabinets, drawer cabinets and wall cabinets provide sleek, robust and hygienic storage suitable for many environments and offer good stability and sound absorption. Base cabinets and wall cabinets have one vertically adjustable shelf. Plain doors with stainless steel 'D' handle are standard.

Doors are ultra-durable with double-skin construction and fully adjustable, high quality, quick-release, hinges. Drawers have smooth and accurate roller-bearing runners. Damped-action closing is standard.

Options

- Continuous, integral, recessed handles (vertical or horizontal)
- Excluding handle (eg. for use with hardware, by others)
- Handleless with back-slope edge to doors
- Key-operated lock
- Fire-retardant core for fire-sensitive areas
- Individual drawers are available (eg. for mounting below worktops)
- Glass (clear, frosted, wired) door with stainless steel frame
- Non-standard sizes

Mounting

- Wall-fixed with up to 100mm clearance eg. for clearance of pipes and or cleaning
- Within GEC Anderson stainless steel legs
- Free-standing with adjustable feet and optional plinth
- Braked castors (zinc-coated steel): Ø125mm rubber tyre. Overall height: 160mm for mobile units

DOORS AND DRAWER FRONTS

Stainless steel doors and drawer fronts are available separately for use with cabinets, by others. Simply specify size and handle choice. Doors are supplied with hinge cut-outs, as required.

HANDLES

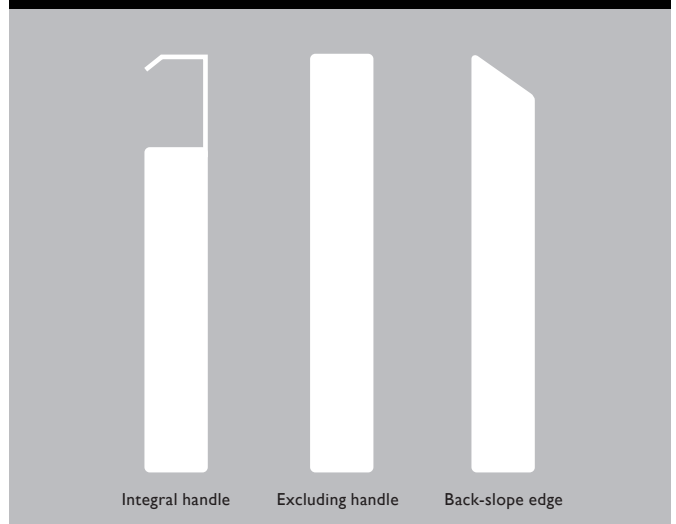

HINGE HOLES

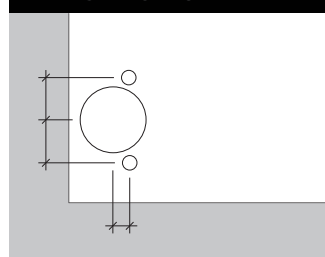

Prepared for standard and non-standard hinges.



**COMPREHENSIVE,
PROFESSIONAL, FRIENDLY
AND EFFICIENT SUPPORT**

- **Technical advice and design guidance**
Available when you need it, regardless of project scale.
- **Rapid product specification and quotation**
Assisting you with meeting deadlines and to safeguard specifications.
- **Secure ordering procedures**
For added assurance and peace of mind.
- **Pre-production CAD drawings**
For clarity, time-saving and added assurance.
- **Dependable, on-time and co-ordinated deliveries**
Helping you to avoid costly delays and adhere to work-programs.
- **Measuring and installation service**
Let us take care of it for you.
- **Cleaning and maintenance guidance**
Full instructions and back up, including the E-cloth® system.
- **Technical product literature**
Carefully designed for clarity and ease of reference.
- **www.gecanderson.co.uk**
Comprehensive product data; case studies and examples; news items; specification clauses and CAD drawings.

Please contact us if we can help you in any way!

ORDERING

Standard products
Often available from stock. Simply provide product reference; quantity required.

Special products
Made to order.

- Please specify your requirements and/or refer to us for quotation and specification
- Upon receipt of order, we will issue our pre-production drawing to you, for approval
- A site visit will be arranged and dimensions and templates will be taken if GEC Anderson is installing for you
- As soon as your approval is obtained, your order will be placed into production
- We will confirm your order, in writing, to you with a confirmed delivery date
- Delivery, to the location of your choice, will be arranged and coordinated
- Installation will be pre-arranged where appropriate

Please indicate any delivery requirements or instructions.

Please ensure safe disposal of packaging.

For clarity and to minimise risk of errors, we ask for orders, in writing please.

INSTALLATION AND MAINTENANCE

Leave plastic surface protection in place until installation is complete. GEC Anderson recommends the E-cloth® system. Alternatively, wash with cold water and detergent. A fine scouring powder will remove persistent stains. Do not use coarse abrasive cleaners or bleach! Strong acids can mark and pit stainless steel.

OTHER PRODUCTS FROM GEC ANDERSON

SANITARYWARE
A comprehensive range of safe and highly durable stainless steel sanitary appliances

DECIMETRIC®
Professional quality, modular kitchen furniture system

'The detailing for the sink area was a crucial element of the overall kitchen design. GEC Anderson was the only supplier able to create exactly what we were looking for and the client was delighted with the final result.'

Mark Levy, Northpoint Design



GEC Anderson Limited Oakengrove Shire Lane Hastoe Tring Hertfordshire HP23 6LY
Tel +44 (0)1442 82 6999 Fax +44 (0)1442 82 5999 info@gecanderson.co.uk www.gecanderson.co.uk

FSC logo to be dropped in here white out on black background

STAINLESS STEEL SANITARYWARE



- WCs
- Urinals
- Wash Troughs
- Basins
- Drinking Fountains
- Mirrors
- Baths
- Sluice Sinks
- Sand Traps
- Bins
- Cleaners' Sink
- StorTidy Shelving

GEC ANDERSON
STAINLESS STEEL
SANITARYWARE
A comprehensive and
economic range of safe
and highly durable
sanitary appliances.

A comprehensive range of safe and highly durable sanitary appliances that is functional, hygienic, attractive and suitable for use in a wide variety of applications including public, commercial, industrial and institutional environments. Examples include: public and commercial washrooms, bathrooms, changing rooms, public areas, general ablution and cleaning areas and staff facilities.



Their non-chip, shatterproof and robust construction makes GEC Anderson sanitary appliances ideal for areas subject to sustained heavy use and vandalism. Hygienic and easy to clean brushed satin stainless steel surfaces make them the practical choice whenever low maintenance, long-life facilities are desirable.

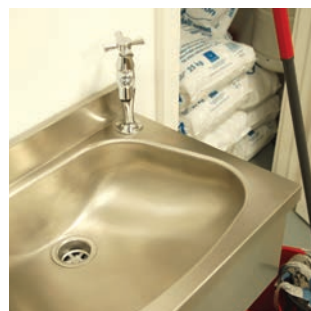

Product Specification Data
Please read in conjunction with
GEC Anderson brochure:
*Sinks, Worktops, Cabinets,
Shelving & Sanitaryware*

WC PANS

GEC Anderson stainless steel WC pans combine an unrivalled trap-performance with minimal flush-volumes (6 litres and below). The security flushing-rim is standard, preventing interference, ligature points and space for contraband. A highly durable outer shroud makes them virtually indestructible, yet highly distinctive, hygienic and attractive. Special adaptations and variations are also available. EN 1.4301 stainless steel.

- V130 low-flush WC and cistern with S-trap or P-trap
- V131 cantilevered wall mounted WC with P-trap and wall fixing plate
- V131 HCP cantilevered wall hung WC for disabled facilities with P-trap and wall fixing plate
- V135 flush to floor and wall WC with P-trap and wall fixing plate
- V32 High-flush WC with S-trap or P-trap. Floor fixed

Standard specification

- Drilled for seat and lid
- Ø38mm push-fit inlet
- Ø100mm trap outlet

Options

- Seat and lid
- Supplied un-drilled
- Seat pads (black isopal)
- Security fixing, excluding plate (not V130)

FLOOR FIXED WC

V130



V130

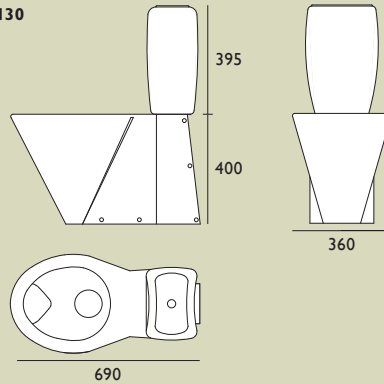

V130 HCP

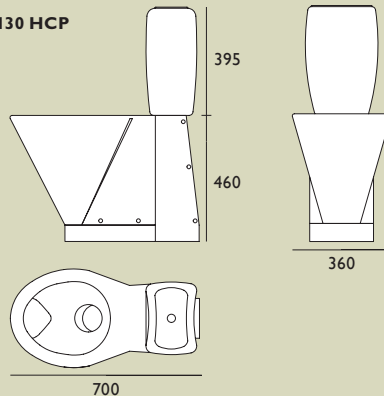

CANTILEVERED WALL MOUNTED WC

V131



V131 HCP

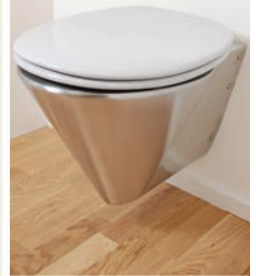

V131

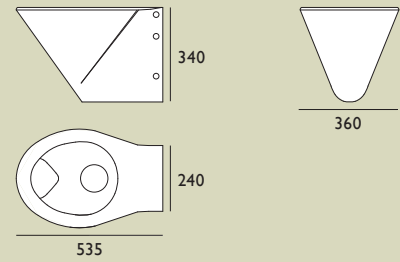

V131 HCP

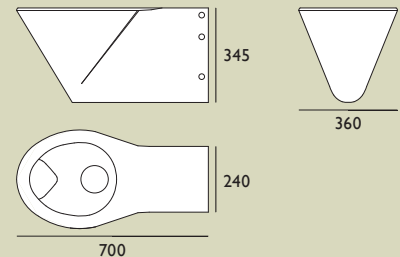

FLOOR FIXED/WALL MOUNTED WC

V135



V135

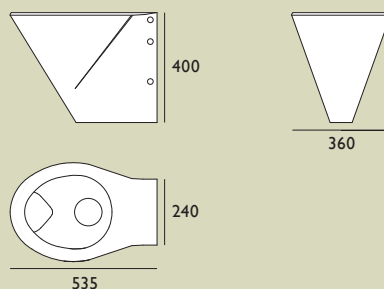

V32



V32

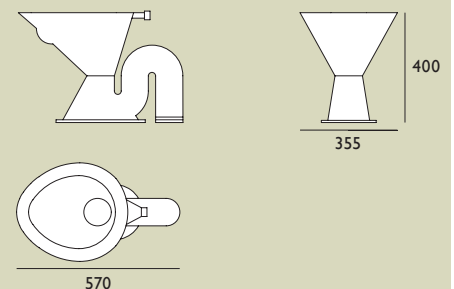

WALL MOUNTED BOWL URINAL

URINALS

GEC Anderson urinals are available in trough and bowl models and are made from EN 1.4401 stainless steel. Recommended installation height: 650mm.

- V345 wall mounted bowl urinal. Spreader plate, 15mm top inlet, Ø38mm grated waste and plastic trap for wall outlet. Concealed top fixing with screw fixing at base
- V301 wall mounted trough urinal with triangular splashguards and concealed sparge pipe. 600 – 3000mm (special sizes to order). Supplied ready for plumbing with Ø38mm grated waste 130mm from left or right. Ø25mm threaded flush pipe inlet fitting. Concealed fixing strip. 600mm length per user space is recommended

Options

- V345 with concealed inlet
- V345 with exposed outlet
- V301 side or back flush pipe inlet connection
- V301 corner boxing for L-shaped sections

WASH TROUGHS

GEC Anderson wash troughs are wall mounted with rear shelf, triangular wall brackets and tapholes as required. 600 – 3000mm (special sizes to order). Supplied ready for plumbing with Ø38mm grated waste 130mm for left or right. 600mm length per user space is recommended. EN 1.4301 stainless steel.

- V240 wash trough with splashback
- V246 wash trough

Option

- V246 with 40mm stand-off fixing position



V345

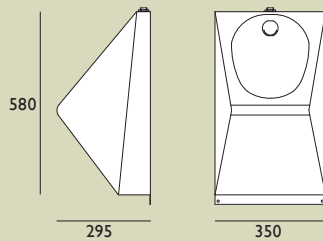

WALL MOUNTED TROUGH URINAL



V301

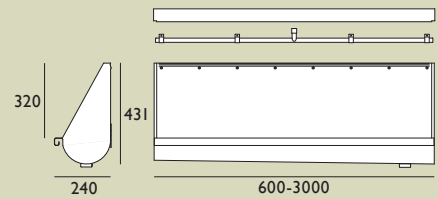

WASH TROUGH WITH SPLASHBACK

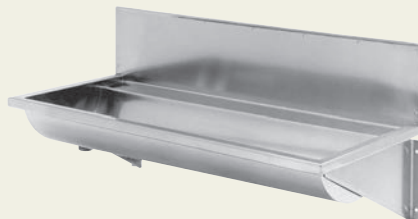

V240

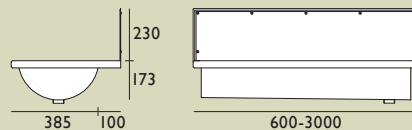

WASH TROUGH

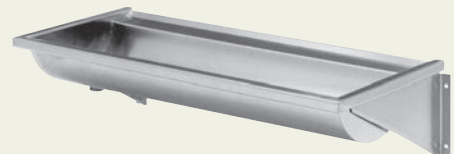

V246

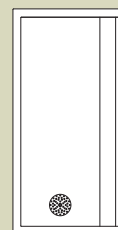
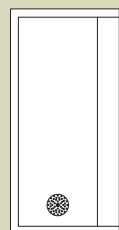

WALL HUNG BASINS – DRINKING FOUNTAINS

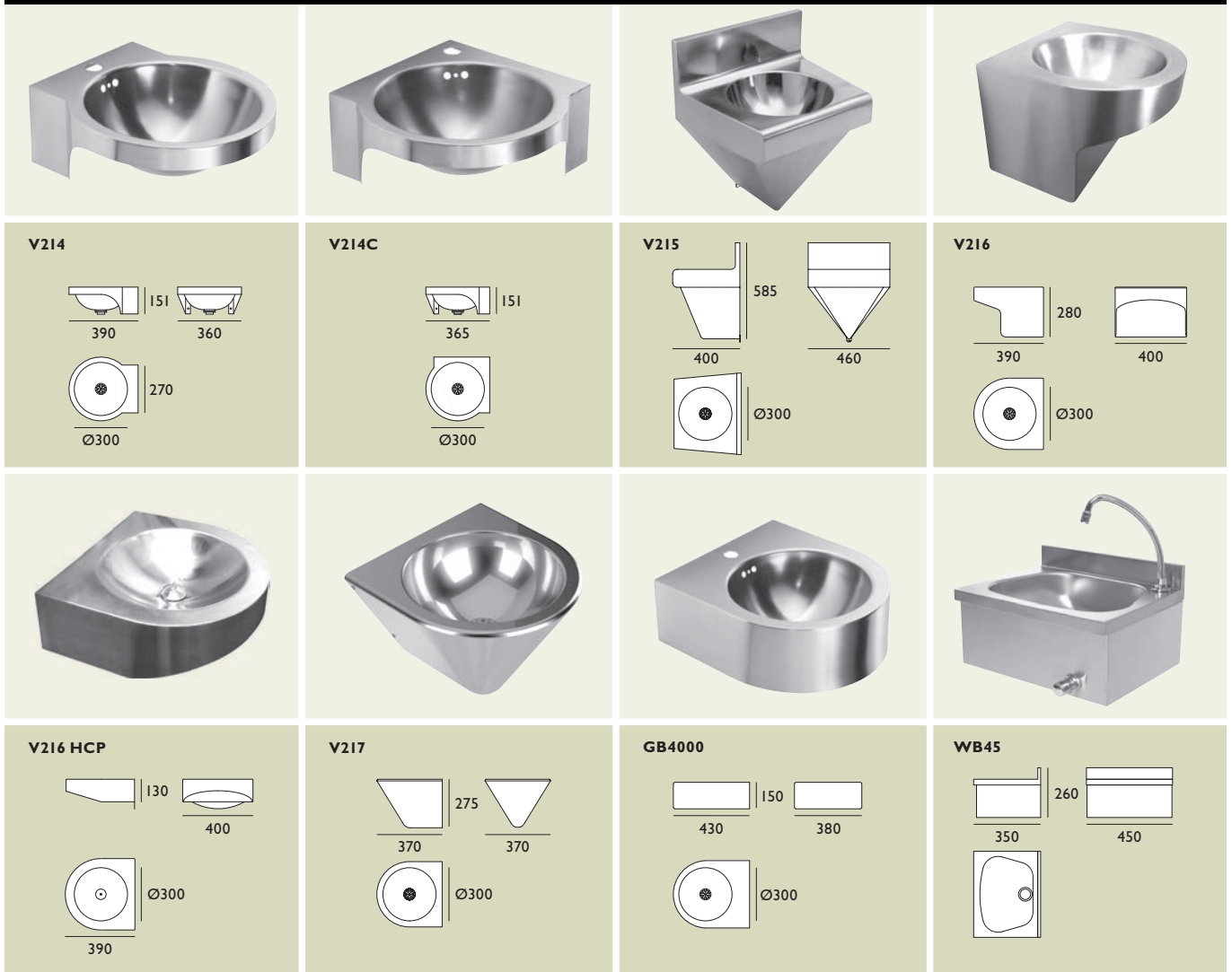

BASINS

GEC Anderson stainless steel basins provide a stylish, hygienic and exceptionally durable solution to indoor and outdoor wash basin **and** drinking fountain requirements. With concealed, integral fixings, smooth edges and corners for improved safety, appearance and easy cleaning. Ø32mm grated waste, outlet, overflow and captive plug. Tapholes as required. EN 1.4301 stainless steel.

- V214 (DF214)
- V214C (DF214C)
- V215
- V216 (DF216)
- V216 HCP
- V217
- GB4000 (DF4000)
- WB45

Options

- Drinking fountain (DF)
- EN 1.4401 stainless steel (not WB45)
- WB45 with knee operated tap and spout

PILLAR FOUNTAINS

GEC Anderson pillar fountains are highly robust with anti-vandal construction from 4.5mm tubular steel, clad with 1mm EN 1.4301 brushed satin stainless steel. Floor fixed with pressure adjustment valves, Ø32mm grated waste and spray nozzle.

- DF210 indoor pillar fountain
- DF211 outdoor pillar fountain with lockable hood and galvanised underground foundation

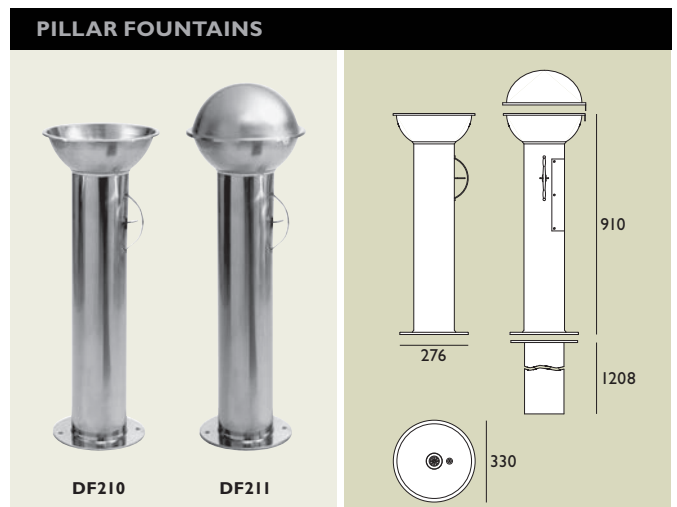



MULTI-STATION BASINS

Multi-station basins are made to order in any length with choice of basins in any position or combination. 100mm front edge profile with 60mm back upstand and concealed fixings.

600mm length per user space is recommended. Supplied ready for plumbing. EN 1.4301 stainless steel.

Options

- Alternative edges
- Tapholes as required

MULTI-STATION BASIN

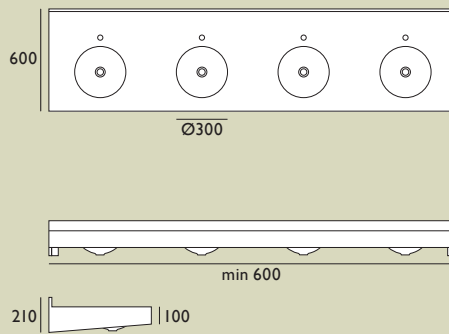

MIRRORS

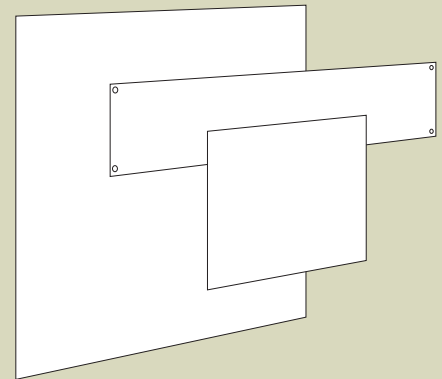

MIRRORS

GEC Anderson mirrors are made in any size (maximum: 2.4 x 1.2 metres) using 1mm EN 1.4301 stainless steel. They are unbreakable, easy to clean and therefore ideal for areas at high risk of vandalism. Fix using pre-drilled screwholes (please specify) or with adhesive.

BATH

GEC Anderson V390 bath is made from 2mm EN 1.4301 stainless steel and is suitable for treatment areas (eg. dermatology) and areas subject to vandalism. Supplied complete with Ø38mm outlet and captive plug. 4 No adjustable feet.

Options

- EN 1.4401 acid resisting grade
- Overflow
- Tapholes
- Side and end panels in EN 1.4301 stainless steel

BATH

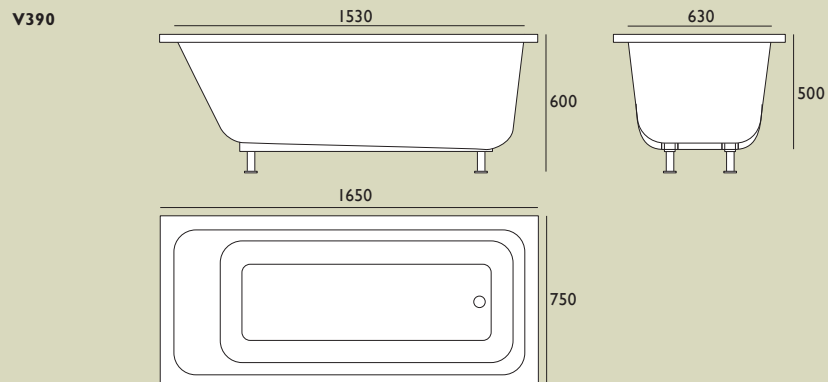

PEDESTAL SLUICE



V15

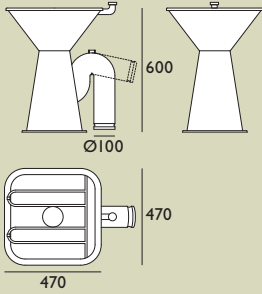

WALL MOUNTED SLUICES



V151

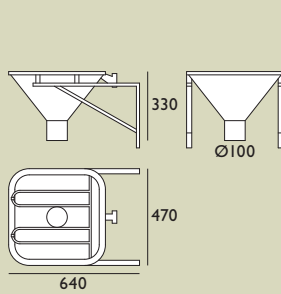

V20

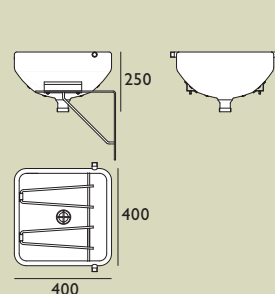

SAND TRAP



V220

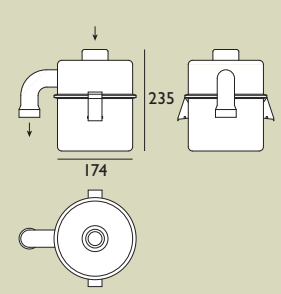

SLUICE SINKS

GEC Anderson sluice sinks with hinged grid, flushing-rim and waste grate can be wall fixed or integral to stainless steel sinktops, with or without additional sink bowl(s). Ready for plumbing. EN 1.4401 stainless steel.

- V151 Ø100mm outlet (excluding trap). Ø38mm push-fit rear inlet suitable for use with cistern or interval supply
- V15 with Ø100mm S-trap. Ø38mm push-fit rear inlet suitable for use with cistern or interval supply
- V20 Ø38mm waste and plastic trap assembly. Ø15mm left or right hand threaded inlet suitable for use with interval supply

Options

- V151 trap assembly
- V15 available with P-trap

SAND TRAPS

GEC Anderson sand traps have an all stainless steel (EN 1.4301 grade) construction for durability, hygiene and professional appearance. A quick-release container allows quick and easy disposal of captured materials. Ø38mm threaded top inlet and reversible left or right outlet fittings.

- V55 gypsum separator provides highly effective separation of finer residues but also heavy metals. A unique combined release-bar and handle ensures rapid waste disposal. Additional wall support is provided via adjustable cantilever brackets. Capacity: 13L.
- V220 sand trap is suitable for use in environments with lower capacity requirements. Capacity: 3L.

GYPSUM SEPARATOR



V55

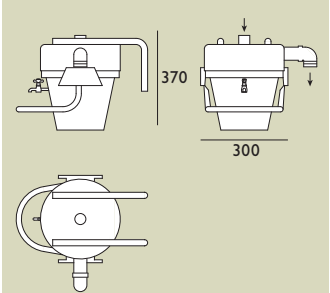

CLEANERS' SINK

GEC Anderson UG40 cleaners' sink is wall mounted with hinged bucket grid and stainless steel splashback – to avoid need for tiling. EN 1.4301 stainless steel.

Options

- Excluding grid
- Excluding splashback



BINS

GEC Anderson bins are smart, durable, easy to clean and functional. With twin castors and Ø60mm rubber tyre, pedal operated lid and available in choice of capacities: 50, 75, 100 litres. EN 1.4301 brushed satin stainless steel.

Option

- Lift-off lid

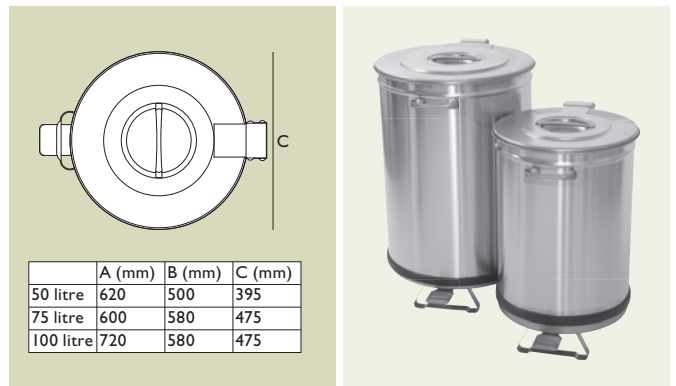
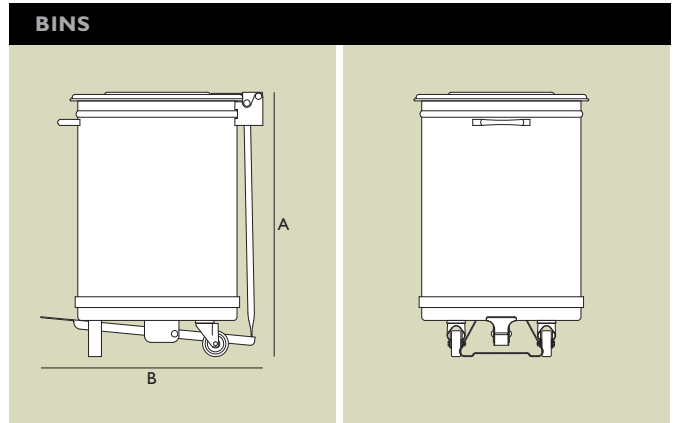
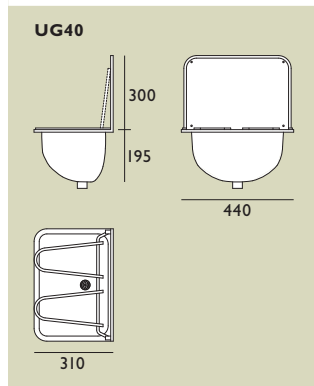

STORTIDY

The GEC Anderson StorTidy is based on the popular, versatile, adaptable, hygienic, neat and durable V90 stepless shelving system and ideally provides professional, open fronted storage in cupboards and stores where space may be limited. The StorTidy is available in 450 and 800mm widths. Non-standard configurations are available to order. EN 1.4301 stainless steel.

- VI08 StorTidy with intermediate 3-bar towel rail
- VIII StorTidy with intermediate shelf and guard rail 315mm
- VI14 StorTidy with intermediate shelf and guard rail 315mm and VI13 bucket sink
- VI13 optional bucket sink 450 or 800 x 415mm

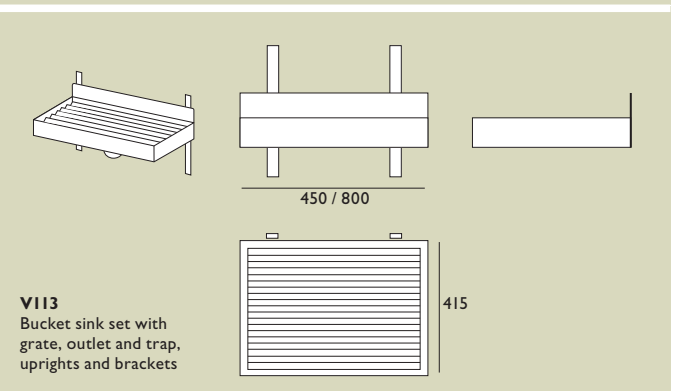
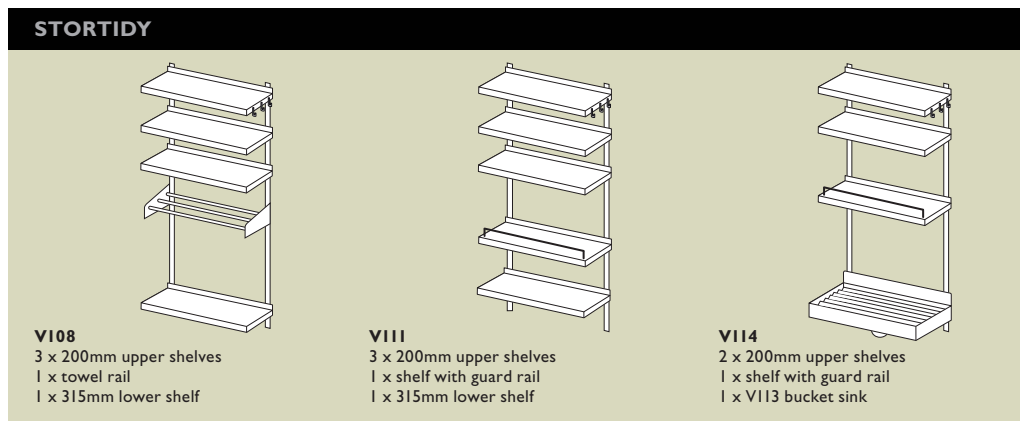

**COMPREHENSIVE,
PROFESSIONAL, FRIENDLY
AND EFFICIENT SUPPORT**

- **Technical advice and design guidance**
Available when you need it, regardless of project scale.
- **Rapid product specification and quotation**
Assisting you with meeting deadlines and to safeguard specifications.
- **Secure ordering procedures**
For added assurance and peace of mind.
- **Pre-production CAD drawings**
For clarity, time-saving and added assurance.
- **Dependable, on-time and co-ordinated deliveries**
Helping you to avoid costly delays and adhere to work-programs.
- **Measuring and installation service**
Let us take care of it for you.
- **Cleaning and maintenance guidance**
Full instructions and back up, including the E-cloth® system.
- **Technical product literature**
Carefully designed for clarity and ease of reference.
- **www.gecanderson.co.uk**
Comprehensive product data; case studies and examples; news items; specification clauses and CAD drawings.

Please contact us if we can help you in any way!

ORDERING

Standard products
Often available from stock. Simply provide product reference; quantity required.

Special products
Made to order.

- Please specify your requirements and/or refer to us for quotation and specification
- Upon receipt of order, we will issue our pre-production drawing to you, for approval
- A site visit will be arranged and dimensions and templates will be taken if GEC Anderson is installing for you
- As soon as your approval is obtained, your order will be placed into production
- We will confirm your order, in writing, to you with a confirmed delivery date
- Delivery, to the location of your choice, will be arranged and coordinated
- Installation will be pre-arranged where appropriate

Please indicate any delivery requirements or instructions.

Please ensure safe disposal of packaging.

For clarity and to minimise risk of errors, we ask for orders, in writing please.

INSTALLATION AND MAINTENANCE

Leave plastic surface protection in place until installation is complete. GEC Anderson recommends the E-cloth® system. Alternatively, wash with cold water and detergent. A fine scouring powder will remove persistent stains. Do not use coarse abrasive cleaners or bleach! Strong acids can mark and pit stainless steel.

OTHER PRODUCTS FROM GEC ANDERSON

MADE-TO-MEASURE
Stainless steel sinks, worktops, cabinets, panels, doors & shelving

DECIMETRIC®
Professional quality, modular kitchen furniture system

'The GEC Anderson stainless steel products and surfaces in the toilets have withstood all wear and tear – without signs of vandalism. The original aim was to specify products that deter and resist vandalism.'

*Robert Davey,
Facilities and Estates, Heart of England NHS Foundation Trust*



GEC Anderson Limited Oakengrove Shire Lane Hastoe Tring Hertfordshire HP23 6LY
Tel +44 (0)1442 82 6999 Fax +44 (0)1442 82 5999 info@gecanderson.co.uk www.gecanderson.co.uk

FSC logo to be dropped in here white out on black background

GEC ANDERSON DECIMETRIC® SYSTEM

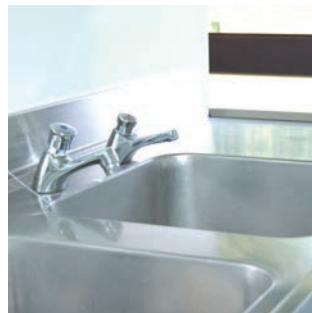

- **Classic Sinks and Worktops**
Plain sink and worktop configurations
- **Drainers**
Standard sink and drainer configurations
- **Frames and Storage**
Stainless steel legs, cabinets, drawers and shelving

GEC ANDERSON DECIMETRIC® SYSTEM
A cost-effective, versatile, flexible and comprehensive modular system of professional-quality stainless steel kitchen furniture that is easy to specify, easy to order and suitable for many environments. Based on 100mm (1 Dm) size increments in the range: 500 – 3000mm long and 600 or 700mm wide.

The GEC Anderson Decimetric® System is intended for commercial environments, such as catering, health, recreation and retail, where furniture must be robust, hygienic and look totally professional. It is produced under strict ISO 9001 quality procedures, using top quality EN 1.4301 grade SatinEase stainless steel.

- A highly flexible and versatile framework of sizes and options enable simple, rapid and accurate specification of **sinks, worksurfaces** and **drainers** with or without support **frames** and **cabinets**.
- **Frames** are available with or without shelf (or multiple shelves).
- Stainless steel **cabinets** are available with hinged or sliding or excluding doors. Drawers can be included (single or in series).
- **Wall cabinets** and **tall cabinets** are available with hinged or sliding or excluding doors.
- **Shelving** is wall mounted and fully adjustable.

Product Specification Data
Please read this Product Specification Data in conjunction with GEC Anderson brochure: *Sinks, Worktops, Cabinets, Shelving & Sanitaryware*

Modularity = Economy = Flexibility = Rapid Availability = Ease

1 Dm = 1 module = 100mm

SURFACES

Surfaces are available in DECIMETRIC® lengths of up to 3800mm (**38 Dm**) and widths of 600mm (**6 Dm**) or 700mm (**7 Dm**). Add **Frames and Storage** (stainless steel legs, cabinets, drawers and shelves), as required (please see pages 6 & 7).

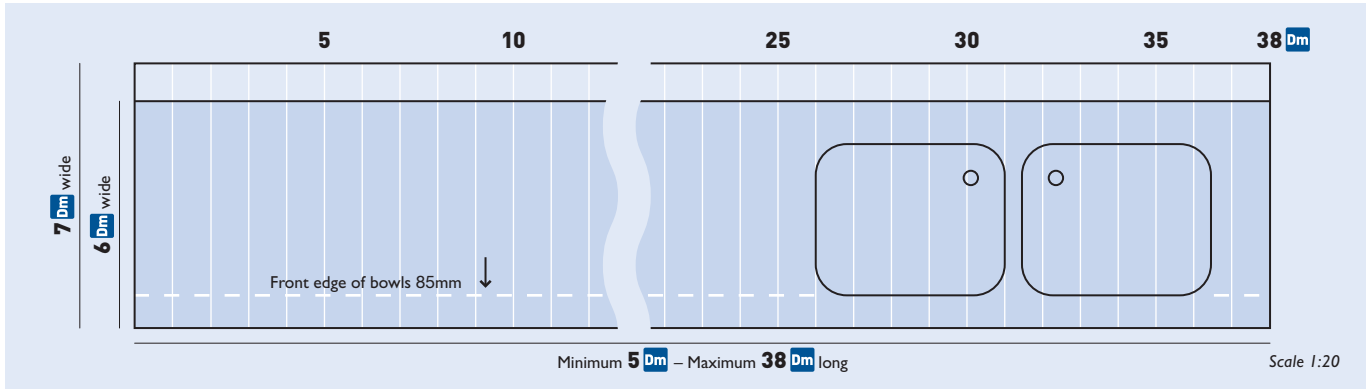

EDGE DETAILS AND UPSTANDS

Edges are 40mm high and are available lipped or plain. Upstand (100 x 20mm) to back edge is optional (side upstand(s) also available).

Tops with bowls have waterproof (lipped) edges and 18mm waterproof board core.

Plain worktops have 18mm waterproof board core.

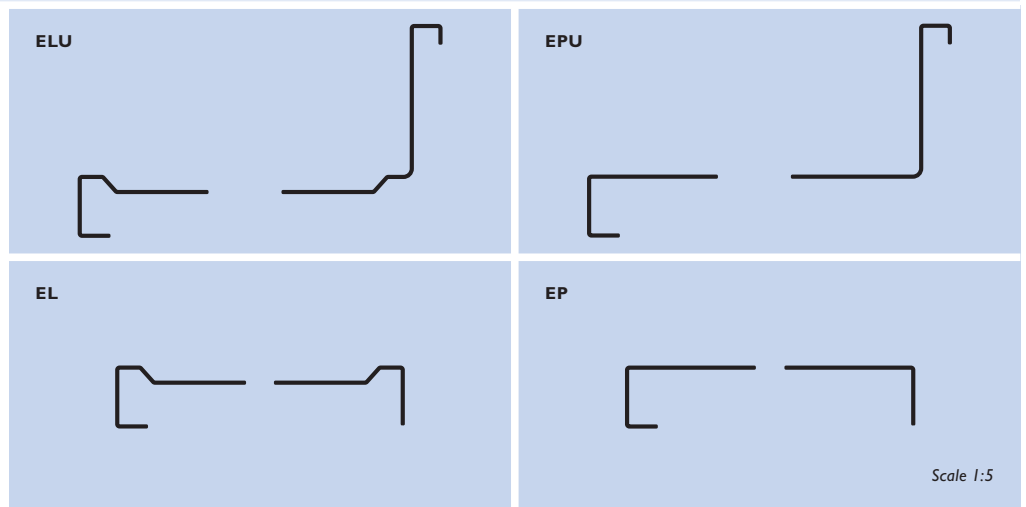

ORDERING & EXAMPLES

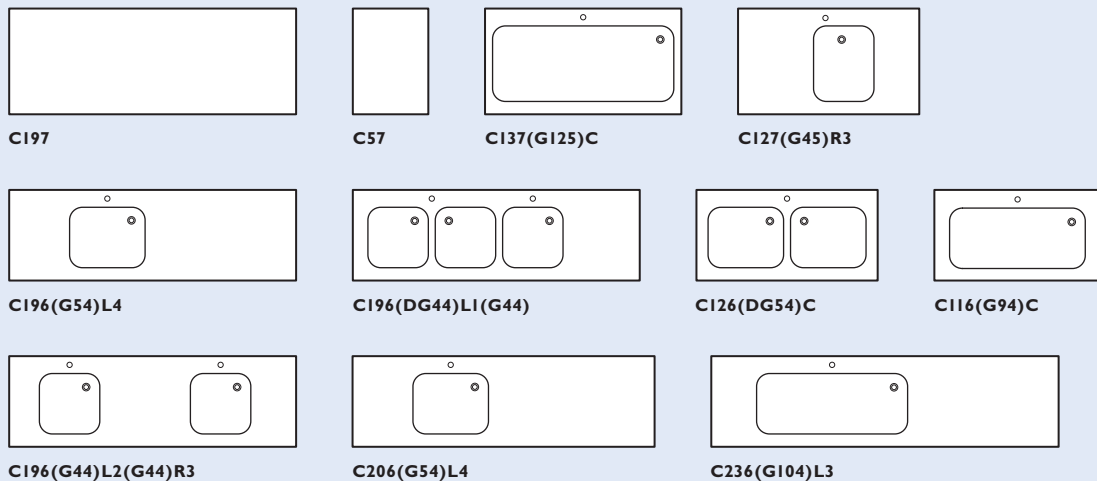

ORDERING

Alternative 1 – Send a sketch (indicating top size, bowl(s) with position and edge reference).

Alternative 2 – Specify product codes as per examples shown. For your peace of mind GEC Anderson can send you a scale drawing for approval before manufacture.

EXAMPLE	Top	Bowl	Position	Edge
20 Dm x 6 Dm Top	= C206			
+ G54 Single bowl	= C206	(G54)		
+ Position C = central	= C206	(G54)	C	
or position 4 Dm from left	= C206	(G54)	L4	
or position 5 Dm from right	= C206	(G54)	R5	
Add edge reference	= C206	(G54)	L4	EP
eg. plain edge no upstand				

1 Dm = 1 module = 100mm

BOWLS

Add sink bowls as required.

Place bowl(s) on module or centrally at least **1 Dm** (100mm) from ends (or ask us).

Supplied as standard with:

- Right-hand outlet
- Ø38mm plug, chain and overflow
- Ø35mm central taphole
- 46mm between bowls
- Anti scratch electropolished finish

Option

- Left-hand outlet
- Stainless steel standpipe overflow with or without corner strainer

Bowls for 6 Dm or 7 Dm wide surfaces (46mm between double bowls)

Scale 1:20

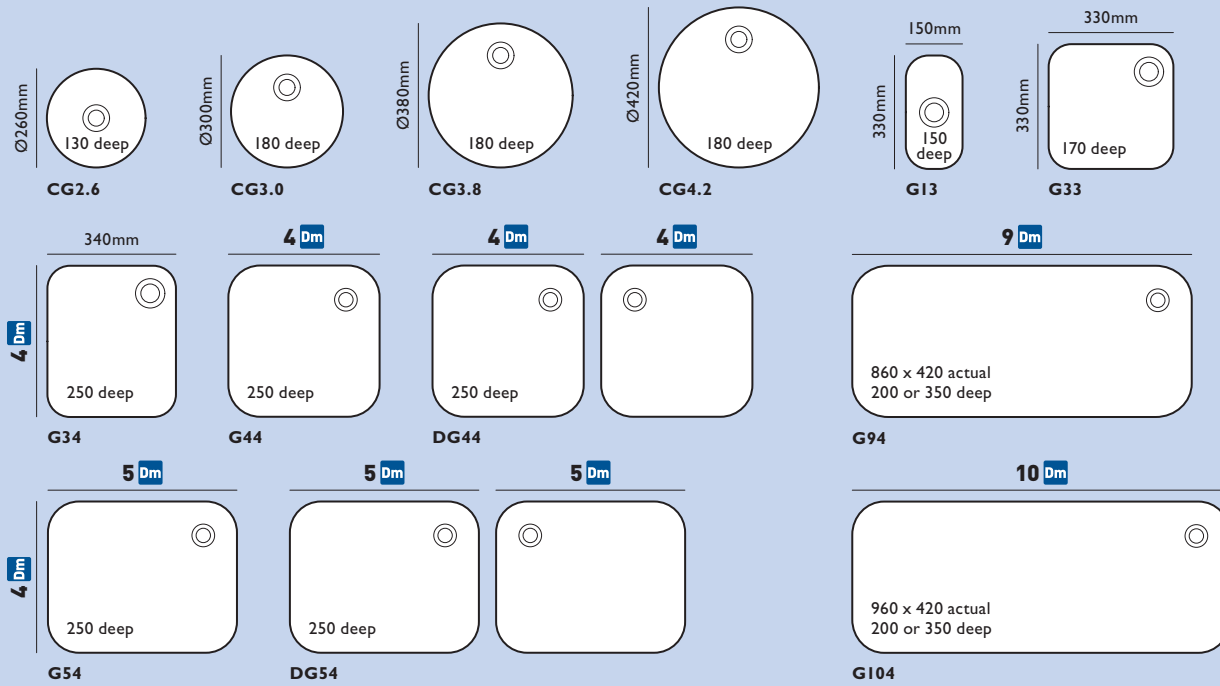

Bowls for 7 Dm wide surfaces only (46mm between double bowls)

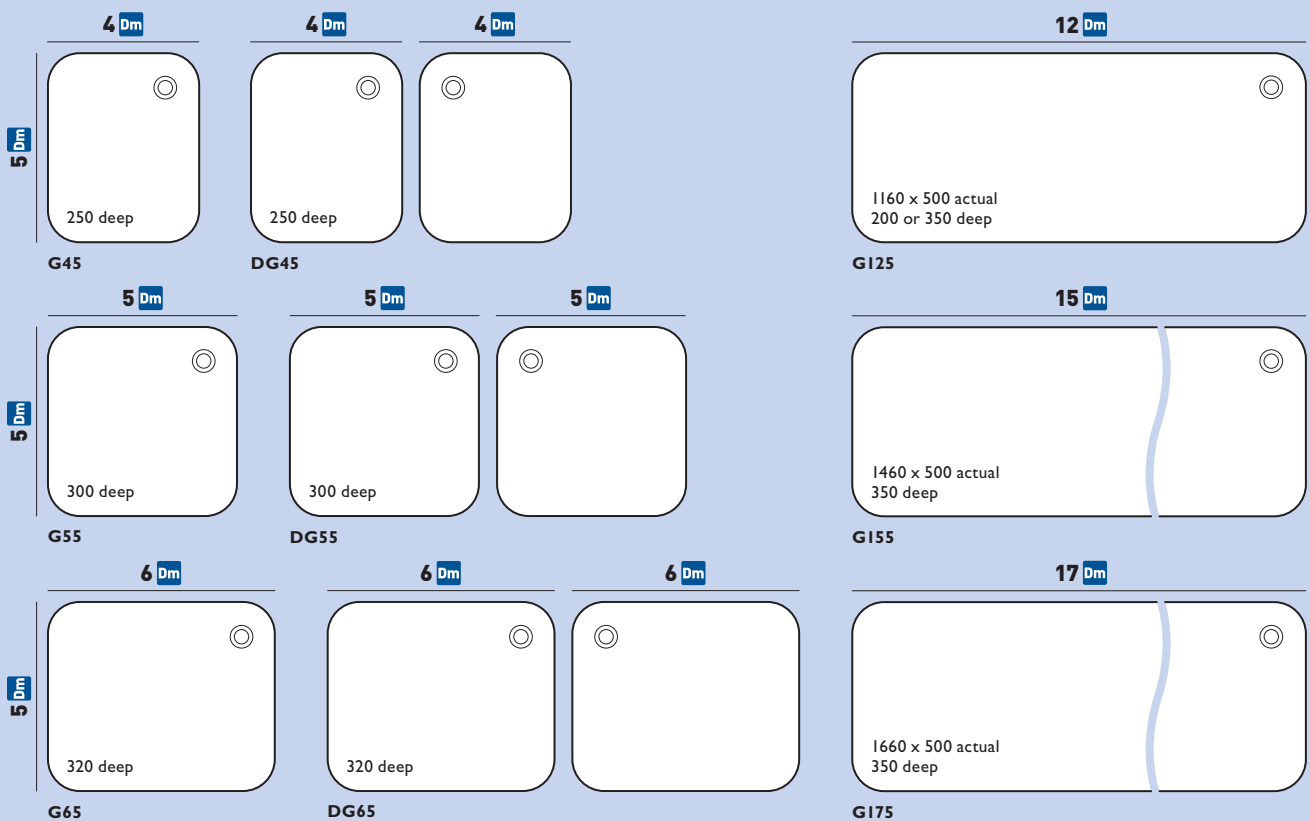

SINGLE BOWL WITH SINGLE DRAINER right or left (shown) 6 Dm and 7 Dm wide

Scale 1:50

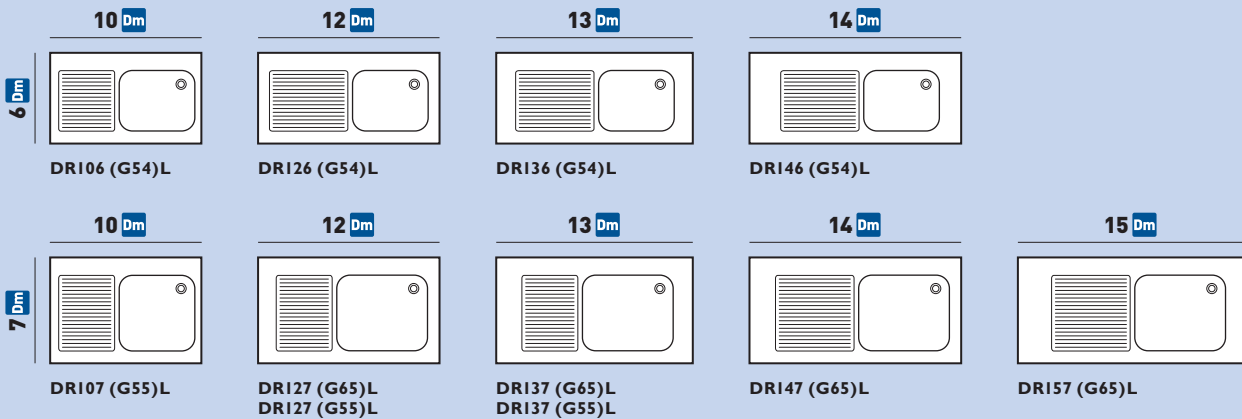

DOUBLE BOWL WITH DOUBLE DRAINER 7 Dm wide

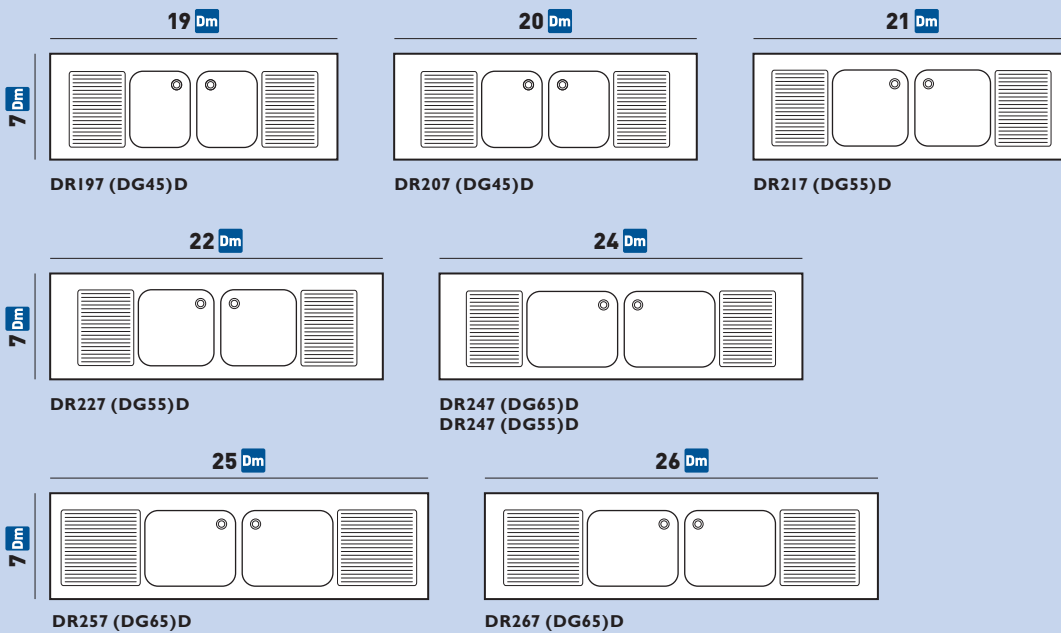

Add Frames and Storage
(stainless steel legs, cabinets, drawers and shelves), as required (please see pages 6 & 7).

EDGE DETAILS AND UPSTANDS

Edges are 40mm high with lipped profile and upstand (100 x 20mm) to back.
Suggested fixing: softwood frame constructed on site.

SINK BOWLS

For dimensions and details of bowls (please see page 3).

DRAINERS

Ribbed area (370 or 520mm long) to facilitate draining.

ELU

* Varies (drainer slopes to bowls)



Scale 1:5

ORDERING & EXAMPLE

ORDERING

Specify code.

EXAMPLE

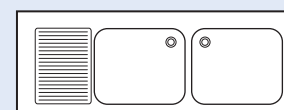

DRI187(DG45)L

Scale 1:50

DOUBLE BOWL WITH SINGLE DRAINER right or left (shown) 6 Dm and 7 Dm wide

Scale 1:50

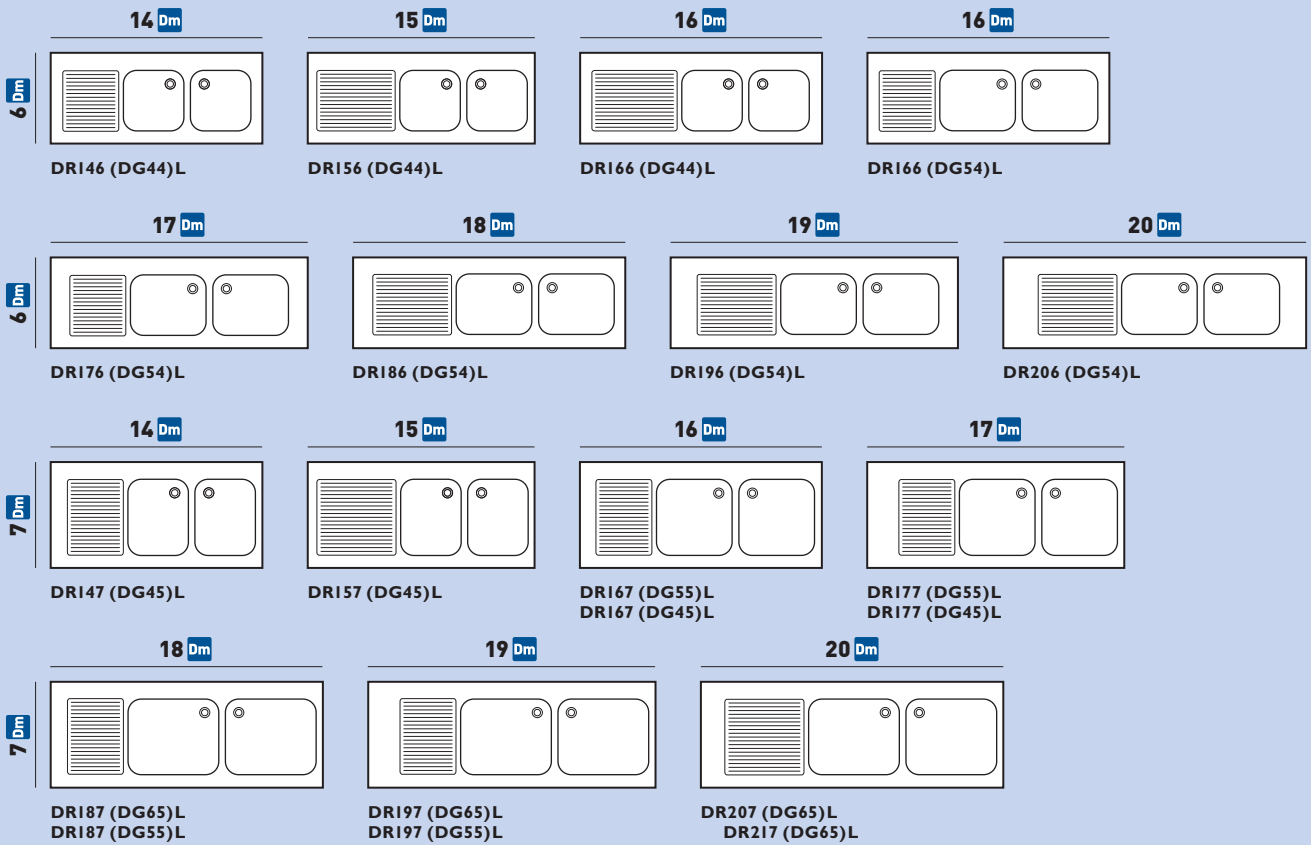

BASE FRAMES F adjustable height (without worktop) 810-860mm, legs 40 x 40mm

<p>Leg</p> <p>F (5-38 Dm)</p>	<p>Leg with brace</p> <p>FB (5-38 Dm)</p>	<p>Leg with shelf</p> <p>FS (5-38 Dm)</p>	<p>Leg with (2) shelves</p> <p>F2S (5-38 Dm)</p>	<p>Option Top drawers 1.5 or 2 Dm high</p> <p>TD1.5 (4-6 Dm) TD2 (4-6 Dm)</p>	<p>Option Panels (back and sides)</p> <p>Example Leg with (2) shelves and panels</p> <p>660mm</p>
-------------------------------	---	---	--	---	---

BASE CABINETS B height (without worktop) 810-860mm including adjustable legs Ø50mm

<p>Open</p> <p>B (4-22 Dm)</p>	<p>Hinged door with shelf</p> <p>B (4-10 Dm) H</p>	<p>Hinged door with drawer(s)</p> <p>B (4-8 Dm) HD 4-6 Dm 1 drawer 7-8 Dm 2 drawers</p>	<p>Sliding door with (2) shelves</p> <p>B (10-22 Dm) S</p>	<p>Option Double-sided cabinet, dual sliding doors with shelf</p> <p>B (10-22 Dm) DS</p>	<p>Option Sliding door with drawer(s)</p> <p>B (10-21 Dm) SD 10-12 Dm 2 drawers 13-16 Dm 3 drawers 17-20 Dm 4 drawers 21 Dm 5 drawers</p>
<p>Drawers</p> <p>BD (4-6 Dm) 2, 3 or 4 drawers</p>	<p>Corner with shelf</p> <p>BC (11 Dm)</p>	<p>Larger base frames, base cabinets and tall cabinets have intermediate support leg</p>			

TALL CABINETS T overall height 15, 18, or 20 Dm with adjustable feet (30mm)

<p>Open with (3) shelves</p> <p>T (6-20 Dm)</p>	<p>Hinged door with (3) shelves</p> <p>T (6-12 Dm) H</p>	<p>Sliding door with (3) shelves</p> <p>T (10-20 Dm) S 1500, 1800, 2000mm</p>	<p>Split sliding door with (2) shelves (2000mm height only)</p> <p>T (10-20 Dm) SS 2000mm</p>
---	--	---	---

SHELVING SH

Shelf

SH (5-30 Dm)

Bracket

SHB (3 or 4 Dm)
20kg safe load

WALL CABINETS W height 6 Dm 50kg safe load

<p>Open with shelf</p> <p>W (4-21 Dm)</p>	<p>Hinged door with shelf</p> <p>W (4-10 Dm) H</p>	<p>Sliding doors with shelf</p> <p>W (10-21 Dm) S</p>	<p>Corner with shelf</p> <p>WC (7 Dm) 660mm</p>	<p>Upright</p> <p>SHU (3, 7 or 10 Dm)</p>
---	--	---	---	---

ORDERING & EXAMPLES

FRAMES AND STORAGE

Use in conjunction with:
Classic sinks and worktops
 Plain sink and worktop configurations (please see pages 2 & 3) or

Drainers Standard sink and drainer configurations (please see pages 4 & 5)

Options

- Doors**
Hinged (single doors upto 700mm), or sliding, or open (excluding doors)
- Handles**
Continuous integral recessed handle
- Locks**
To doors or drawers
- Open backs**
Base cabinets with open backs (eg. for plumbing)
- Sloping tops**
Wall cabinets (not corner model) with 20° sloping top to aid cleaning
- Shelves**
Additional shelves to base frames and base cabinets
- Front and side valance**
(Base frames only)
Standard: 90mm
Options: 50, 150, 200 or 300mm
- Castors**
Ø125mm castors (one pair braked). Teflon / stainless steel or rubber / zinc plated

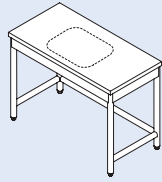

C136 + FBRI36
Plain stainless steel top (or with bowls) and leg unit

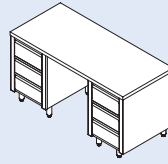

C157 + FR157 + BD47(3) + BD47(3)
Plain stainless steel top with frame and drawer cabinet

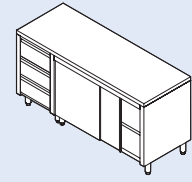

C177 + BD47(3) + B137S
Plain stainless steel top with drawers and sliding door/cabinet

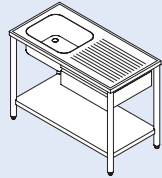

DR136(G54)R + FSRI36 + TD6(2)
Drainer top with drawer and leg unit

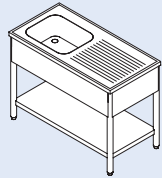

DR136(G54)R + FSRI36 + V3
Drainer top with valance to hide sink and leg unit

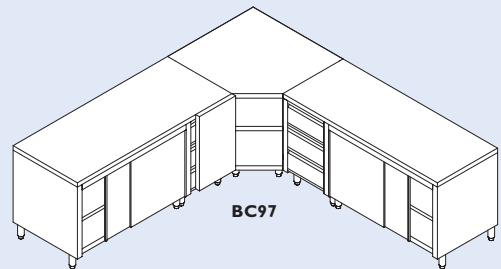
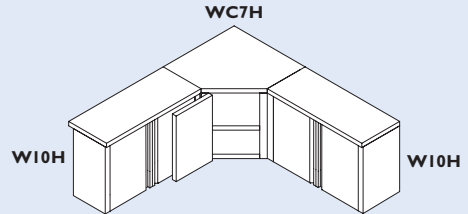

C177 + BD47(3) + B137S
Upper and lower units with corner cabinets

C177 + BD47(3) + B137S

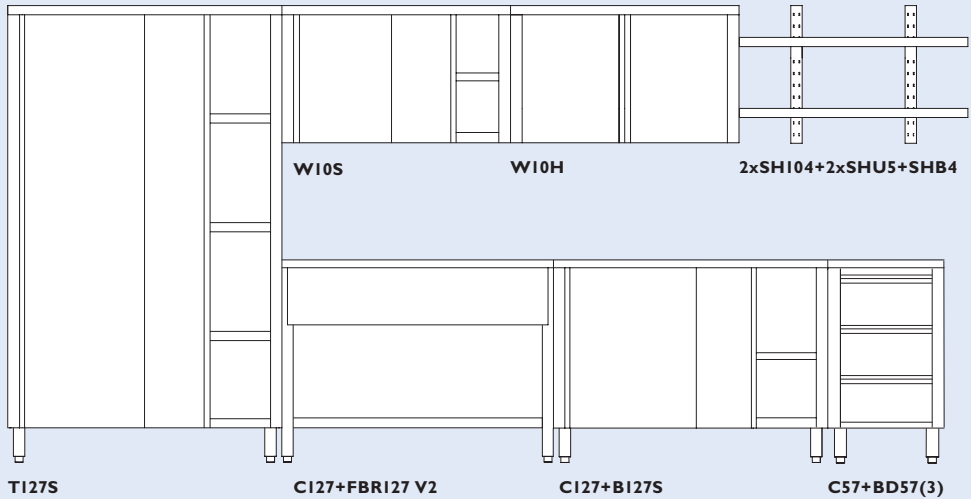

ORDERING

Alternative 1 – Send a sketch (indicating length, width and type of unit).

Alternative 2 – Specify product codes as per examples shown. For your peace of mind GEC Anderson can send you a scale drawing for approval before manufacture.

EXAMPLE	Type	Size	Feature
12 Dm x 7 Dm Legs	F	127	
20 Dm x 6 Dm Legs with shelf	FS	206	
22 Dm x 7 Dm Base cabinet with sliding doors and 5 drawers	B	227	SD(5)

1 Dm = 1 module = 100mm

**COMPREHENSIVE,
PROFESSIONAL, FRIENDLY
AND EFFICIENT SUPPORT**

- **Technical advice and design guidance**
Available when you need it, regardless of project scale.
- **Rapid product specification and quotation**
Assisting you with meeting deadlines and to safeguard specifications.
- **Secure ordering procedures**
For added assurance and peace of mind.
- **Pre-production CAD drawings**
For clarity, time-saving and added assurance.
- **Dependable, on-time and co-ordinated deliveries**
Helping you to avoid costly delays and adhere to work-programs.
- **Measuring and installation service**
Let us take care of it for you.
- **Cleaning and maintenance guidance**
Full instructions and back up, including the E-cloth® system.
- **Technical product literature**
Carefully designed for clarity and ease of reference.
- **www.gecanderson.co.uk**
Comprehensive product data; case studies and examples; news items; specification clauses and CAD drawings.

Please contact us if we can help you in any way!

ORDERING

Standard products
Often available from stock. Simply provide product reference; quantity required.

Special products
Made to order.

- Please specify your requirements and/or refer to us for quotation and specification
- Upon receipt of order, we will issue our pre-production drawing to you, for approval
- As soon as your approval is obtained, your order will be placed into production
- We will confirm your order, in writing, to you with a confirmed delivery date
- Delivery, to the location of your choice, will be arranged and coordinated

Please indicate any delivery requirements or instructions.

Please ensure safe disposal of packaging.

For clarity and to minimise risk of errors, we ask for orders, in writing please.

INSTALLATION AND MAINTENANCE

Leave plastic surface protection in place until installation is complete. GEC Anderson recommends the E-cloth® system. Alternatively, wash with cold water and detergent. A fine scouring powder will remove persistent stains. Do not use coarse abrasive cleaners or bleach! Strong acids can mark and pit stainless steel.

OTHER PRODUCTS FROM GEC ANDERSON

MADE-TO-MEASURE
Stainless steel sinks, worktops, cabinets, panels, doors & shelving

SANITARYWARE
A comprehensive range of safe and highly durable stainless steel sanitary appliances

'GEC Anderson were able to custom make the sinktop in a very short time and everyone has been very pleased with it.

I'm very glad that the other make was not available. The other big advantage of the Decimetric® product is that its 100mm modular size interments permit specification of the largest possible unit to fit a space, without the premium of a true bespoke installation.'

*Robert Gritton,
Milton Keynes Council*



GEC Anderson Limited Oakengrove Shire Lane Hastoe Tring Hertfordshire HP23 6LY
Tel +44 (0)1442 82 6999 Fax +44 (0)1442 82 5999 info@gecanderson.co.uk www.gecanderson.co.uk

FSC logo to be dropped
in here white out on
black background