

Theme Bins International Ltd

Established 1991



www.themebins.co.uk

Street Furniture 2019

Litter Bins Cycle Storage Seating Recycling Bins Lockers Planters Tables

Index	2
Personalised Bins	3
Micro Litter Bins	4+5
Midi Litter Bins	6+7
Continental Litter Bins	8
Colonial Litter Bins	9
Imperial Litter Bins	10
Provincial Litter Bins	11
Open Top Universal Litter Bins	12
Universal Litter Bins	13
Twist Litter Bins	14+15
Popular Litter Bins	16
Popular Twin Bins	17
Drinks Can Litter Bins	18+19
Classic Litter Bins	20
Slimline Classic Litter Bins	21
Animal Litter Bins	22
Monster Litter Bins	23
Pencil Litter Bins	24
Mushroom Litter Bins	25
Metalware and Cigarette Disposal	26
Recycling Bins	27 to 29
Wall and Post Mounted Bins	30
Grit Bins	30
Meeting Point Table	31
Wooden Picnic Table and Bench Set	31
Modular Seating	32+33
Junior Jigsaw Table Set	34
Junior Table Set	35
Zigzag Bench	36
Spiral Bench	37
Learning Curve	38
Learning Arena	39
Jigsaw Table and Bench	40
Star Bench	41
Double-Sided Seat	42
Wall Seat and Wall Bench	43
Multicoloured and Stone Effect Bench	44+45
Multicoloured and Stone Effect Seat	46+47
Multicoloured and Stone Effect Table and Bench Sets	48+49
Table and Seat Sets	50
Planters	51
Multi-Purpose Lockers	52+53
BykeBins	54+55



Personalised Litter Bins

Theme Bins specialises in supplying products with customers own personalised graphics. To aid the graphics application we offer a **free computer visualisation service** by our in-house designers. If you are unsure please call and ask for assistance.

Tel 0844 8794154



1. Company logo



2. Free computer visualisation



3. Finished product



Products on site



Micro Litter Bins



With Personalised Graphics and Localised Graphics

Theme Bins specialises in supplying products with customers own personalised graphics. To aid the graphics application we offer a **free computer visualisation service** by our in-house designers. If you are unsure please call and ask for assistance. Tel 0844 8794154



Open Top Lid
MIC-O

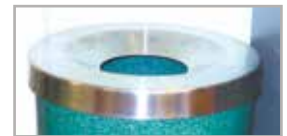

Stainless Steel Lid
MIC-SL

FEATURES

- Polyethylene bodyshell
- Galvanised steel liner (Can be supplied with plastic liner if preferred)
- Hygienic, easy to clean
- Environmentally friendly, made from recyclable plastic

Code	Product	Height	Diameter	Capacity	Weight	Price
MIC-O	Bin with OPEN TOP LID and tidy logo	740mm	390mm	42L	8.8 kg	£154.00
MIC-O-LG	Bin with localised graphics (A3 size)					£169.25
MIC-O	Bin with 1 colour wrap					£174.00
MIC-O	Bin with 2 colour wrap					£184.00
MIC-O	Bin with 3 colour wrap					£194.00
MIC-O	Bin with 4+ colour wrap					£204.00
MIC-SL	Bin with STEEL LID and tidy logo	650mm	390mm	42L	9.4 kg	£154.00
MIC-SL-LG	Bin with localised graphics (A3 size)					£169.25
MIC-SL	Bin with 1 colour wrap					£174.00
MIC-SL	Bin with 2 colour wrap					£184.00
MIC-SL	Bin with 3 colour wrap					£194.00
MIC-SL	Bin with 4+ colour wrap					£204.00
*GFB	Ground fixing bolts per bin	-	-	-	-	£14.00
*LK	Lock and key (excluding MIC-SL)	-	-	-	-	£18.00

*optional extra

There is a £60.00 artwork set-up charge for all personalised orders of 3 units and under.

All prices are subject to VAT but include delivery to any UK Mainland site. Deliveries to Northern Ireland and the Scottish Highlands add £15.00 + VAT per bin.



Colours available:
Stone effect and Plain



Micro Litter Bins



With Personalised Graphics and Localised Graphics

Theme Bins specialises in supplying products with customers own personalised graphics. To aid the graphics application we offer a **free computer visualisation service** by our in-house designers. If you are unsure please call and ask for assistance. Tel 0844 8794154



Black flip top lid
MIC-FT



Stainless steel flip top lid
MIC-FTS

FEATURES

- Polyethylene bodyshell
- Galvanised steel liner (Can be supplied with plastic liner if preferred)
- Hygienic, easy to clean
- Environmentally friendly, made from recyclable plastic

Code	Product	Height	Diameter	Capacity	Weight	Price
MIC-FT	Bin with BLACK FLIP LID and tidy logo	740mm	390mm	42L	8.8 kg	£187.75
MIC-FT-LG	Bin with localised graphics (A3 size)					£203.00
MIC-FT	Bin with 1 colour wrap					£207.75
MIC-FT	Bin with 2 colour wrap					£217.75
MIC-FT	Bin with 3 colour wrap					£227.75
MIC-FT	Bin with 4+ colour wrap					£237.75
MIC-FTS	Bin with STEEL FLIP LID and tidy logo	740mm	390mm	42L	8.8 kg	£194.75
MIC-FTS-LG	Bin with localised graphics (A3 size)					£210.00
MIC-FTS	Bin with 1 colour wrap					£214.75
MIC-FTS	Bin with 2 colour wrap					£224.75
MIC-FTS	Bin with 3 colour wrap					£234.75
MIC-FTS	Bin with 4+ colour wrap					£244.75
*GFB	Ground fixing bolts per bin	-	-	-	-	£14.00
*LK	Lock and key	-	-	-	-	£18.00

*optional extra

There is a £60.00 artwork set-up charge for all personalised orders of 3 units and under.

All prices are subject to VAT but include delivery to any UK Mainland site. Deliveries to Northern Ireland and the Scottish Highlands add £15.00 + VAT per bin.

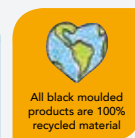

Midi Litter Bins with Open Top Lids

With Tidy Logo



MI-O £164.25 per bin



MI-SL £164.25 per bin

With Personalised Graphics and Localised Graphics

Theme Bins specialises in supplying products with customers own personalised graphics. To aid the graphics application we offer a **free computer visualisation service** by our in-house designers. If you are unsure please call and ask for assistance. Tel 0844 8794154



MI-O £184.25



MI-SL £204.25



MI-SL £214.25



Open Top Lid
MI-O

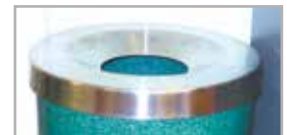

Stainless Steel Lid
MI-SL

FEATURES

- Polyethylene bodyshell
- Galvanised steel liner (Can be supplied with plastic liner if preferred)
- Hygienic, easy to clean
- Environmentally friendly, made from recyclable plastic

Code	Product	Height	Diameter	Capacity	Weight	Price
MI-O	Bin with OPEN TOP LID and tidy logo	860mm	390mm	52L	9.7 kg	£164.25
MI-O-LG	Bin with localised graphics (A3 size)					£179.50
MI-O	Bin with 1 colour wrap					£184.25
MI-O	Bin with 2 colour wrap					£194.25
MI-O	Bin with 3 colour wrap					£204.25
MI-O	Bin with 4+ colour wrap					£214.25
MI-SL	Bin with STEEL LID and tidy logo	780mm	390mm	52L	10.3 kg	£164.25
MI-SL-LG	Bin with localised graphics (A3 size)					£179.50
MI-SL	Bin with 1 colour wrap					£184.25
MI-SL	Bin with 2 colour wrap					£194.25
MI-SL	Bin with 3 colour wrap					£204.25
MI-SL	Bin with 4+ colour wrap					£214.25
*GFB	Ground fixing bolts per bin	-	-	-	-	£14.00
*LK	Lock and key (not MIC-SL)	-	-	-	-	£18.00

*optional extra

There is a £60.00 artwork set-up charge for all personalised orders of 3 units and under.

All prices are subject to VAT but include delivery to any UK Mainland site. Deliveries to Northern Ireland and the Scottish Highlands add £15.00 + VAT per bin.



Colours available:
Stone effect and Plain



Midi Litter Bins with Flip Top Lids

With Tidy Logo



With Personalised Graphics and Localised Graphics

Theme Bins specialises in supplying products with customers own personalised graphics. To aid the graphics application we offer a **free computer visualisation service** by our in-house designers. If you are unsure please call and ask for assistance. Tel 0844 8794154



MI-FT £228.00



MI-FT £248.00



MI-FTS £255.00



Black flip top lid
MI-FT



Stainless steel flip top lid
MI-FTS

FEATURES

- Polyethylene bodyshell
- Galvanised steel liner (Can be supplied with plastic liner if preferred)
- Hygienic, easy to clean
- Environmentally friendly, made from recyclable plastic

Code	Product	Height	Diameter	Capacity	Weight	Price
MI-FT	Bin with BLACK FLIP LID and tidy logo	860mm	390mm	52L	9.7 kg	£198.00
MI-FT-LG	Bin with localised graphics (A3 size)	"	"	"	"	£213.25
MI-FT	Bin with 1 colour wrap	"	"	"	"	£218.00
MI-FT	Bin with 2 colour wrap	"	"	"	"	£228.00
MI-FT	Bin with 3 colour wrap	"	"	"	"	£238.00
MI-FT	Bin with 4+ colour wrap	"	"	"	"	£248.00
MI-FTS	Bin with STEEL FLIP LID and tidy logo	860mm	390mm	52L	10.3 kg	£205.00
MI-FTS-LG	Bin with localised graphics (A3 size)	"	"	"	"	£220.25
MI-FTS	Bin with 1 colour wrap	"	"	"	"	£225.00
MI-FTS	Bin with 2 colour wrap	"	"	"	"	£235.00
MI-FTS	Bin with 3 colour wrap	"	"	"	"	£245.00
MI-FTS	Bin with 4+ colour wrap	"	"	"	"	£255.00
*GFB	Ground fixing bolts per bin	-	-	-	-	£14.00
*LK	Lock and key	-	-	-	-	£18.00

*optional extra

There is a £60.00 artwork set-up charge for all personalised orders of 3 units and under.

All prices are subject to VAT but include delivery to any UK Mainland site. Deliveries to Northern Ireland and the Scottish Highlands add £15.00 + VAT per bin.

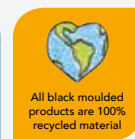

Colours available:
Stone effect and Plain



Continental Litter Bins

With Tidy Logo



pale granite

CB £174.50



emerald



red

With Personalised Graphics and Localised Graphics

Theme Bins specialises in supplying products with customers own personalised graphics. To aid the graphics application we offer a **free computer visualisation service** by our in-house designers. If you are unsure please call and ask for assistance.

Tel 0844 8794154

Ashtrays optional extra



CB-A

Black Ashtray



CB-AD

Stainless Steel Domed

Paper Slot

Paper slot for confidential waste + confidential waste graphics



CB-S



CB £224.50



CB £204.50



CB £204.50

FEATURES

•Polyethylene bodyshell •Lock and key •Galvanised steel liner (Can be supplied with plastic liner if preferred) •Hygienic, easy to clean •Environmentally friendly, made from recyclable plastic

Code	Product	Height	Diameter	Capacity	Weight	Price
CB	Bin with tidy logo	950mm	390mm	52L	11 kg	£174.50
CB-LG	Bin with localised A3 graphics					£189.75
CB-S	Bin with paper slot					£174.50
CB	Bin with 1 colour wrap					£194.50
CB	Bin with 2 colour wrap					£204.50
CB	Bin with 3 colour wrap					£214.50
CB	Bin with 4+ colour wrap					£224.50
*A	Black Ashtray	-	-	-	-	£20.25
*AD	Domed Ashtray	-	-	-	-	£42.75
*GFB	Ground fixing bolts per bin	-	-	-	-	£14.00

*optional extra

All prices are subject to VAT but include delivery to any UK Mainland site. Deliveries to Northern Ireland and the Scottish Highlands add £15.00 + VAT per bin.

Colours available:
Stone effect and Plain



There is a £60.00 artwork set-up charge for all personalised orders of 3 units and under.

Colonial Litter Bins

With Tidy Logo



With Personalised Graphics and Localised Graphics

Theme Bins specialises in supplying products with customers own personalised graphics. To aid the graphics application we offer a **free computer visualisation service** by our in-house designers. If you are unsure please call and ask for assistance.

Tel 0844 8794154



COL-SL £205.50



COL-SL-LG £200.00



COL-FT £225.00



Stainless Steel Open Top Lid
COL-SL



Stainless Steel Flip Top Lid
COL-FT

FEATURES

- Polyethylene bodyshell
- Galvanised steel liner (Can be supplied with plastic liner if preferred)
- Hygienic, easy to clean
- Environmentally friendly, made from recyclable plastic



Code	Product	Height	Diameter	Capacity	Weight	Price
COL-SL	Bin with OPEN TOP LID and tidy logo	790mm	390mm	70L	11.9 kg	£184.50
COL-SL-LG	Bin with localised graphics (A3 size)					£200.00
COL-SL	Bin with 1 colour wrap					£204.50
COL-SL	Bin with 2 colour wrap					£214.50
COL-SL	Bin with 3 colour wrap					£224.50
COL-SL	Bin with 4+ colour wrap					£234.50
COL-FT	Bin with FLIP TOP LID and tidy logo	790mm	390mm	70L	11.9 kg	£205.00
COL-FT-LG	Bin with localised graphics (A3 size)					£220.25
COL-FT	Bin with 1 colour wrap					£225.00
COL-FT	Bin with 2 colour wrap					£235.00
COL-FT	Bin with 3 colour wrap					£245.00
COL-FT	Bin with 4+ colour wrap					£255.00
*GFB	Ground fixing bolts per bin	-	-	-	-	£14.00

*optional extra

There is a £60.00 artwork set-up charge for all personalised orders of 3 units and under.

All prices are subject to VAT but include delivery to any UK Mainland site. Deliveries to Northern Ireland and the Scottish Highlands add £15.00 + VAT per bin.



Premier Stone Effect Imperial Litter Bins



dark millstone



sapphire



dark millstone



pale granite

black

sandstone

sapphire

dark millstone

emerald

IB £296.75 per bin

FEATURES

- Environmentally friendly, made from recyclable plastic
- Polyethylene bodyshell
- Galvanised steel liner
- Hygienic, easy to clean
- Lock and key
- Fold down door



Code	Product	Height	Width	Depth	Capacity	Weight	Price
IB	Single bin	1040mm	550mm	545mm	100L	28kg	£296.75
*GFBI	Ground fixing bolts	-	-	-	-	-	£24.25

All prices are subject to VAT but include delivery to any UK Mainland site. Deliveries to Northern Ireland and the Scottish Highlands add £15.00 + VAT per bin.

Colours available: Stone effect and Plain

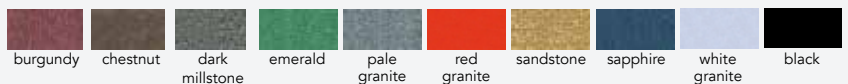

Provincial Litter Bins

With Tidy Logo



Pivots for easy emptying



PV-4 £812.00 set of 4

FEATURES

- Polyethylene bodyshell
- Galvanised steel liner
- Hygienic, easy to clean
- Environmentally friendly, made from recyclable plastic
- Pivoting door for easy emptying

Code	Product	Height	Width	Depth	Capacity	Weight	Price
PV	Single bin	920mm	510mm	400mm	39L	22.5kg	£208.00
PV-4	Set of 4						£812.00
*GFB	Ground fixing bolts per bin	-	-	-	-	-	£14.00

*optional extra

Door Colours available:

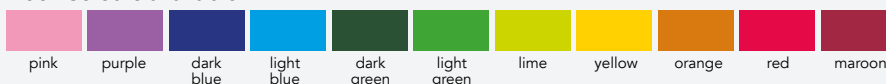

All prices are subject to VAT but include delivery to any UK Mainland site. Deliveries to Northern Ireland and the Scottish Highlands add £15.00 + VAT per bin.



Open Top Universal Litter Bins



UNO £183.00 per bin

With Tidy Logo



red

With Personalised Graphics and Localised Graphics

Theme Bins specialises in supplying products with customers own personalised graphics. To aid the graphics application we offer a **free computer visualisation service** by our in-house designers. If you are unsure please call and ask for assistance. Tel 0844 8794154



UNO £203.00



UNO £233.00



UNO-CS £276.75

Gold Banding



UNO-GB £193.25

FEATURES

- Polyethylene bodyshell
- Galvanised steel liner (Can be supplied with plastic liner if preferred)
- Hygienic, easy to clean
- Environmentally friendly, made from recyclable plastic
- Weighted base

Code	Product	Height	Diameter	Capacity	Weight	Price
UNO	Bin with tidy logo	810mm	520mm	90L	18 kg	£183.00
UNO-GB	Bin with gold banding					£193.25
UNO-LG	Bin with localised graphics (A3 size)					£198.50
UNO	Bin with 1 colour wrap					£203.00
UNO	Bin with 2 colour wrap					£213.00
UNO	Bin with 3 colour wrap					£223.00
UNO	Bin with 4+ colour wrap					£233.00
*GFB	Ground fixing bolts per bin	-	-	-	-	£14.00
*BS	Internal steel base plate + fixing bolts	-	-	-	-	£27.00
*PF	Pre-drilled paving flag + fixing bolts	-	-	-	-	£31.00
*CS	Set of castors: 2 free wheeling/2 breaking	-	-	-	-	£43.75

*optional extra

There is a £60.00 artwork set-up charge for all personalised orders of 3 units and under.

All prices are subject to VAT but include delivery to any UK Mainland site. Deliveries to Northern Ireland and the Scottish Highlands add £15.00 + VAT per bin.



Universal Litter Bins



With Tidy Logo

Ashtrays optional extra



Stainless Steel Domed



Black Ashtray

With Personalised Graphics and Localised Graphics

Theme Bins specialises in supplying products with customers own personalised graphics. To aid the graphics application we offer a **free computer visualisation service** by our in-house designers. If you are unsure please call and ask for assistance. Tel 0844 8794154



Gold Banding



FEATURES

- Polyethylene bodyshell
- Galvanised steel liner (Can be supplied with plastic liner if preferred)
- Hygienic, easy to clean
- Environmentally friendly, made from recyclable plastic
- Cigarette stub plate
- Weighted base

Code	Product	Height	Diameter	Capacity	Weight	Price
UNL	Bin with tidy logo	1130mm	520mm	90L	22 kg	£203.50
UNL-LG	Bin with localised graphics (A3 size)					£218.75
UNL-GB	Bin with gold banding					£213.75
UNL	Bin with 1 colour wrap					£223.50
UNL	Bin with 2 colour wrap					£233.50
UNL	Bin with 3 colour wrap					£243.50
UNL	Bin with 4+ colour wrap					£253.50
*A	Black ashtray	-	-	-	-	£18.75
*AD	Stainless steel domed ashtray	-	-	-	-	£37.75
*GFB	Pair of ground fixing bolts	-	-	-	-	£14.00
*BS	Internal steel base plate + fixing bolts	-	-	-	-	£27.00
*PF	Pre-drilled paving flag + fixing bolts	-	-	-	-	£31.00

Colours available:
Stone effect and Plain



*optional extra

There is a £60.00 artwork set-up charge for all personalised orders of 3 units and under.

All prices are subject to VAT but include delivery to any UK Mainland site. Deliveries to Northern Ireland and the Scottish Highlands add £15.00 + VAT per bin.



Twist Litter Bins



Code	Product	Height	Diameter	Capacity	Weight	Price
T	Bin with tidy logo	1130mm	520mm	90L	22 kg	£209.50
T-F	Bin with 'Frog' graphics	"	"	"	"	£212.75
T-L	Bin with 'Litter Please' logo	"	"	"	"	£212.75
*GFB	Ground fixing bolts per bin	-	-	-	-	£14.00

*optional extra

FEATURES

- Polyethylene bodyshell
- Galvanised steel liner (Can be supplied with plastic liner if preferred)
- Lock and key
- Hygienic, easy to clean
- Environmentally friendly, made from recyclable plastic
- Weighted base

Colours available: Stone effect and Plain



All prices are subject to VAT but include delivery to any UK Mainland site. Deliveries to Northern Ireland and the Scottish Highlands add £15.00 + VAT per bin.

There is a £60.00 artwork set-up charge for all personalised orders of 3 units and under.

Twist Litter Bins

Twist with 'Frog' Graphics



Twist with 'Litter Please' Graphics



Popular Litter Bin

With Litter Please



POP-L £167.25 per bin



With Tidy Logo



POP £164.25 per bin

Please select lid and body colour

Code	Product	Height	Diameter	Capacity	Weight	Price
POP	Popular Bin with tidy logo	790mm	390mm	70L	10.2kg	£164.25
POP-4	Popular Bin with tidy logo set of 4	"	"	"	"	£641.00
POP-L	Popular with 'litter please'	"	"	"	"	£167.25
POP-L-4	Popular with 'litter please' set of 4	"	"	"	"	£653.00
*GFB	Ground fixing bolts per bin	-	-	-	-	£14.00

*optional extra

Colours available:

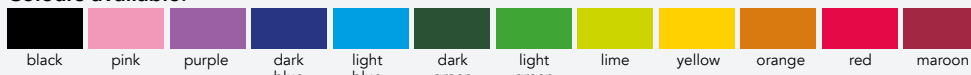

All prices are subject to VAT but include delivery to any UK Mainland site. Deliveries to Northern Ireland and the Scottish Highlands add £15.00 + VAT per bin.

FEATURES

- Polyethylene bodyshell
- Galvanised steel liner (Can be supplied with plastic liner if preferred)
- Hygienic, easy to clean
- Environmentally friendly, made from recyclable plastic



+44 (0)844 8794154



themebins@btconnect.com

Popular Twin Bin

With Tidy Logo



POPT £238.75

With 'Litter Please'



POPT-L £241.75

With Localised Graphics



POPT-LG £254.00



Code	Product	Height	Width	Depth	Capacity	Weight	Price
POPT	Twin bin with 'tidy logo'	790mm	800mm	410mm	2 x 70L	20.3kg	£238.75
POPT-L	Twin bin with 'litter please'	"	"	"	"	"	£241.75
POPT-LG	Twin Bin with localised graphics (A3 size)	"	"	"	"	"	£254.00
*GFB	Ground fixing bolts per bin	-	-	-	-	-	£14.00

*optional extra

FEATURES

- Polyethylene bodyshell
- 2 x galvanised steel liners (Can be supplied with plastic if preferred)
- Hygienic, easy to clean
- Environmentally friendly, made from recyclable plastic

Colours available: Stone effect and Plain



All prices are subject to VAT but include delivery to any UK Mainland site. Deliveries to Northern Ireland and the Scottish Highlands add £15.00 + VAT per bin.

Please select lid and body colour



Drinks Can Litter Bins



DC £203.50 per bin

With Tidy Logo

FEATURES

- Polyethylene bodyshell
- Pivoting ring-pull lid
- Galvanised steel liner (Can be supplied with plastic liner if preferred)
- Hygienic, easy to clean
- Environmentally friendly, made from recyclable plastic
- Lock and key
- UV stable
- Cigarette stub plate
- Weighted base

Code	Product	Height	Diameter	Capacity	Weight	Price
DC	Drinks Can with tidy logo	900mm	520mm	90L	23.5 kg	£203.50
DC-LG	Drinks Can with localised 'A3' graphics					£218.75
DC	Drinks Can with 1 colour wrap					£223.50
DC	Drinks Can with 2 colour wrap					£233.50
DC	Drinks Can with 3 colour wrap					£243.50
DC	Drinks Can with 4+ colour wrap					£253.50
DC-CB	Catering Bin and tidy logo	900mm	520mm	90L	23.5 kg	£205.50
DC-CB-LG	Catering Bin with localised 'A3' graphics					£220.50
DC-CB	Catering Bin with 1 colour wrap					£225.50
DC-CB	Catering Bin with 2 colour wrap					£235.50
DC-CB	Catering Bin with 3 colour wrap					£245.50
DC-CB	Catering Bin with 4+ colour wrap					£255.50
*GFB	Ground fixing bolts per bin	-	-	-	-	£14.00
*BS	Internal steel base plate + fixing bolts	-	-	-	-	£27.00
*PF	Pre-drilled paving flag + fixing bolts	-	-	-	-	£31.00
*CS	Set of castors: 2 free wheeling/2 breaking	-	-	-	-	£43.75

*optional extras for Drinks Can and Catering Bin

There is a £60.00 artwork set-up charge for all personalised orders of 3 units and under.

All prices are subject to VAT but include delivery to any UK Mainland site. Deliveries to Northern Ireland and the Scottish Highlands add £15.00 + VAT per bin.



Colours available:



Drinks Can with Personalised Graphics



DC £253.50

Stock Graphic

With Personalised Graphics and Localised Graphics

Theme Bins specialises in supplying products with customers own personalised graphics. To aid the graphics application we offer a **free computer visualisation service** by our in-house designers. If you are unsure please call and ask for assistance. Tel 0844 8794154



DC £253.50

DC £253.50

DC £253.50

DC £233.50

Drinks Can with Catering Lid

Our Drinks Can with Catering Lid has a larger aperture than our regular Drinks Can and is ideal for promotions and easy disposal of kitchen waste.



Castors are an optional extra



DC-CB £299.25



DC-CB £299.25



Premier Stone Effect Classic Bin

With Tidy Logo



With Personalised Graphics and Localised Graphics

Theme Bins specialises in supplying products with customers own personalised graphics. To aid the graphics application we offer a **free computer visualisation service** by our in-house designers. If you are unsure please call and ask for assistance. **Tel 0844 8794154**



FEATURES

•Polyethylene bodyshell •Lock and key •Galvanised steel liner (Can be supplied with plastic liner if preferred) •Hygienic, easy to clean •Environmentally friendly, made from recyclable plastic

Code	Product	Height	Diameter	Capacity	Weight	Price
C	Bin with tidy logo	1130mm	520mm	90L	23.2kg	£209.50
C-LG	Bin with localised graphics (A3 size)					£225.00
C	Bin with 1 colour wrap					£229.50
C	Bin with 2 colour wrap					£239.50
C	Bin with 3 colour wrap					£249.50
C	Bin with 4+ colour wrap					£259.50
*GFB	Ground fixing bolts per bin	-	-	-	-	£14.00
*BS	Internal steel base plate + fixing bolts	-	-	-	-	£27.00
*PF	Pre-drilled paving flag + fixing bolts	-	-	-	-	£31.00

*optional extra

There is a £60.00 artwork set-up charge for all personalised orders of 3 units and under.

All prices are subject to VAT but include delivery to any UK Mainland site. Deliveries to Northern Ireland and the Scottish Highlands add £15.00 + VAT per bin.

Colours available: Stone effect and Plain



Slimline Classic Litter Bins



With Personalised Graphics and Localised Graphics

Theme Bins specialises in supplying products with customers own personalised graphics. To aid the graphics application we offer a **free computer visualisation service** by our in-house designers. If you are unsure please call and ask for assistance. Tel 0844 8794154



Ashtray optional extra



Stainless Steel Domed

Code	Product	Height	Diameter	Capacity	Weight	Price
SC	Single bin with tidy logo	940mm	390mm	52L	10.5 kg	£174.50
SC-4	Set of 4 with tidy logo	''	''	''	''	£682.00
SC-LG	Single bin with localised graphics A4 size	''	''	''	''	£189.75
SC	Bin with 1 colour personalised wrap	''	''	''	''	£194.50
SC	Bin with 2 colour personalised wrap	''	''	''	''	£204.50
SC	Bin with 3 colour personalised wrap	''	''	''	''	£214.50
SC	Bin with 4+ colour personalised wrap	''	''	''	''	£224.50
*A	Ashtray	-	-	-	-	£32.50
*GFB	Ground fixing bolts per bin	-	-	-	-	£14.00

*optional extra

Colours available: Stone effect and Plain

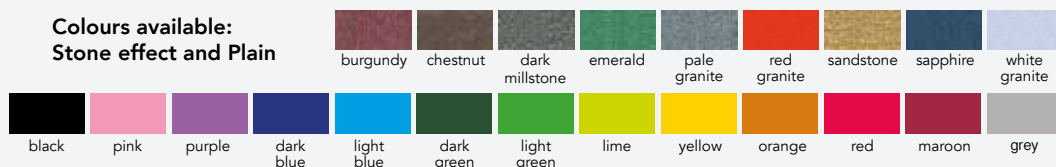

FEATURES

- Polyethylene bodyshell
- Galvanised steel liner (Can be supplied with plastic liner if preferred)
- Lock and key
- Hygienic, easy to clean
- Environmentally friendly, made from recyclable plastic

All prices are subject to VAT but include delivery to any UK Mainland site. Deliveries to Northern Ireland and the Scottish Highlands add £15.00 + VAT per bin.

There is a £60.00 artwork set-up charge for all personalised orders of 3 units and under.



Animal Litter Bins

Also available: Bear, Fox and Mouse



PAN-S £181.50

Small Panda

PAN-L £186.75

Large Panda



CHK-S Small Chick £181.50
CHK-L Large Chick £186.75



PENG-S Small Penguin £181.50
PENG-L Large Penguin £186.75



FRG-S Small Frog £181.50
FRG-L Large Frog £186.75



LEP-S Small Leopard £181.50
LEP-L Large Leopard £186.75



CAT-S Small Cat £181.50
CAT-L Large Cat £186.75



TIG-S Small Tiger £181.50
TIG-L Large Tiger £186.75

FEATURES

- Polyethylene bodyshell
- Galvanised steel liner (Can be supplied with plastic liner if preferred)
- Lock and key
- Hygienic, easy to clean
- Environmentally friendly, made from recyclable plastic

	Height	Diameter	Capacity	Weight	Price single	Price set of 4
Small	930mm	390mm	42L	10.5kg	£181.50	£706.00
Large	1050mm	390mm	52L	11.3kg	£186.75	£727.00
(Chick and Penguin)						
Small	820mm	390mm	42L	10.5kg	£181.50	£706.00
Large	940mm	390mm	52L	11.3kg	£186.75	£727.00

optional extra: **GFB** ground fixing bolts per bin £14.00



Litter opening in back of lid

All prices are subject to VAT but include delivery to any UK Mainland site. Deliveries to Northern Ireland and the Scottish Highlands add £15.00 + VAT per bin.

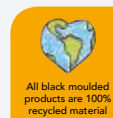

Please select required animals for sets.

Monster Litter Bins



Purple



Light Blue



Orange



Dark Blue

MONL-4 £727.00 set of 4 large bins Please state required colours.



Red

Black

Pink

Green

Choose from Lime, Purple, Light Blue, Orange, Dark Blue, Red, Black, Pink and Green. Also available: Maroon, Yellow and Grey.

FEATURES

- Polyethylene bodyshell
- Galvanised steel liner (Can be supplied with plastic liner if preferred)
- Lock and key
- Hygienic, easy to clean
- Environmentally friendly, made from recyclable plastic

Litter opening in back of lid

Code	Product	Height	Diameter	Capacity	Weight	Price
MONS	Small Monster	930mm	390mm	42L	10.5kg	£181.50
MONS-4	Small Monster set of 4					£706.00
MONL	Large Monster	1050mm	390mm	52L	11.3kg	£186.75
MONL-4	Large Monster set of 4					£727.00
*GFB	Ground fixing bolts per bin	-	-	-	-	£14.00

*optional extra

All prices are subject to VAT but include delivery to any UK Mainland site. Deliveries to Northern Ireland and the Scottish Highlands add £15.00 + VAT per bin.



Please state required colours when ordering



Pencil Litter Bins



 A set of 4 are supplied in light blue, red, yellow and light green or choose your own colours.



Code	Product	Height	Diameter	Capacity	Weight	Price
PMIC	Plain micro size bin	1040mm	390mm	42L	10.5 kg	£169.25
PMIC-4	Plain micro size bin set of 4	"	"	"	"	£661.00
PMID	Plain midi size bin	1200mm	390mm	52L	11.8kg	£173.50
PMID-4	Plain midi size bin set of 4	"	"	"	"	£678.00
PMIC-L	Micro size bin with 'litter letters'	1040mm	390mm	42L	10.5kg	£174.50
PMIC-L-4	Micro size bin with 'litter letters' set of 4	"	"	"	"	£682.00
PMID-L	Midi size bin with 'litter letters'	1200mm	390mm	52L	11.8kg	£178.50
PMID-L-4	Midi size bin with 'litter letters' set of 4	"	"	"	"	£698.00
*GFB	Ground fixing bolts per bin	-	-	-	-	£14.00

*optional extra

Colours available:

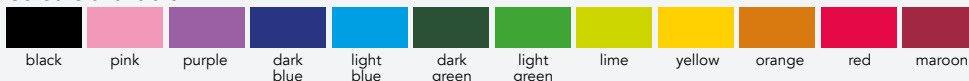

FEATURES

- Polyethylene bodyshell
- Galvanised steel liner (Can be supplied with plastic liner if preferred)
- Lock and key
- Hygienic, easy to clean
- Environmentally friendly, made from recyclable plastic

All prices are subject to VAT but include delivery to any UK Mainland site. Deliveries to Northern Ireland and the Scottish Highlands add £15.00 + VAT per bin.



Mushroom Litter Bins



MUL £231.00 per bin

With 'Litter Letters'



Colour of spots may vary or choose your own spot colour

With 'Door Graphics'



MUDR £236.25 per bin

With 'Bugs'



MUB £231.00

FEATURES

- Polyethylene bodyshell •Galvanised steel liner (Can be supplied with plastic liner if preferred)
- Lock and key •Hygienic, easy to clean •Environmentally friendly, made from recyclable plastic

Code	Product	Height	Diameter	Capacity	Weight	Price
MUL	Mushroom with 'Litter Letters'	900mm	720mm	90L	26 kg	£231.00
MUL-4	Mushroom with 'Litter Letters' set of 4					£904.00
MUDR	Mushroom with 'Door Graphics'					£236.25
MUDR-4	Mushroom with 'Door Graphics' set of 4					£925.00
MUB	Mushroom with 'Bugs'					£231.00
MUB-4	Mushroom with 'Bugs' set of 4					£904.00
*GFB	Ground fixing bolts per bin	-	-	-	-	£14.00

*optional extra

Colours available:



All prices are subject to VAT but include delivery to any UK Mainland site. Deliveries to Northern Ireland and the Scottish Highlands add £15.00 + VAT per bin.

Use key to unlock then lift and twist body to access liner. Once empty, replace the body and press lock.



Cigarette Disposal



CDB-G £167.25



pale granite



sapphire



CDB-W £167.25



FEATURES

- Quick and easy to empty
- Stainless steel grid for extinguishing cigarettes
- Polyethylene bodyshell
- Can be wall mounted or ground fixed
- Lock and key
- Hygienic, easy to clean
- Environmentally friendly, made from recyclable plastic

Code	Product	Height	Diameter	Width	Depth	Capacity	Weight	Price
CDB-G	Cigarette bin (ground)	940mm	160mm	-	-	5L	7 kg	£167.25
CDB-W	Cigarette bin (wall)	940mm	160mm	-	-	5L	5.5 kg	£167.25
WAL-C	Wall mounted cigarette bin	390mm	-	280mm	140mm	2L	2kg	£108.75

Colours available for CDB-G and CDB-W



Metalware Cigarette Disposal

Textured metal cigarette disposal bin available in green and silver.

WAL-C £108.75



Textured Green



Textured Silver

All prices are subject to VAT but include delivery to any UK Mainland site. Deliveries to Northern Ireland and the Scottish Highlands add £15.00 + VAT per bin.

Battery Recycling Bin

FEATURES

- Polyethylene bodyshell
- Galvanised steel liner (Can be supplied with plastic liner if preferred)
- Lock and key
- Hygienic, easy to clean
- Environmentally friendly, made from recyclable plastic

Colours available:



Code	Product	Height	Diameter	Capacity	Weight	Price
BRB	Bin with banding	960mm	390mm	52L	10 kg	£184.50
BRB+	Bin with 'be positive' graphics					£194.75
BRB	Bin with 1 colour personalised wrap					£204.50
BRB	Bin with 2 colour personalised wrap					£214.50
BRB	Bin with 3 colour personalised wrap					£224.50
BRB	Bin with 4+ colour personalised wrap					£234.50
*GFB	Ground fixing bolts per bin	-	-	-	-	£14.00

*optional extra

There is a £60.00 artwork set-up charge for all personalised orders of 3 units and under.

All prices are subject to VAT but include delivery to any UK Mainland site. Deliveries to Northern Ireland and the Scottish Highlands add £15.00 + VAT per bin.



BRB £184.50



Stock Graphic

BRB+ £194.75

Twin Recycling Bins

Twin Recycling



POP-RT £243.75



POP-RT £243.75

Choose your recycling message when ordering.
Cans, Plastic, Paper, Bottles, Fruit, Cardboard, Glass.
Organic Waste, Aluminium, Batteries or Silver Foil.

Examples of Personalised Twin Recycling



POPT-LG £254.00



POPT-LG £254.00

Please select lid and body colour

Code	Product	Height	Width	Depth	Capacity	Weight	Price
POP-RT	Twin bin with 'recycling graphic'	790mm	800mm	410mm	2 x 70L	20.3kg	£243.75
POPT-LG	Twin Bin with localised graphics (A3 size)						£254.00
*GFB	Ground fixing bolts per bin	-	-	-	-	-	£14.00

*optional extra

Colours available: Stone effect and Plain

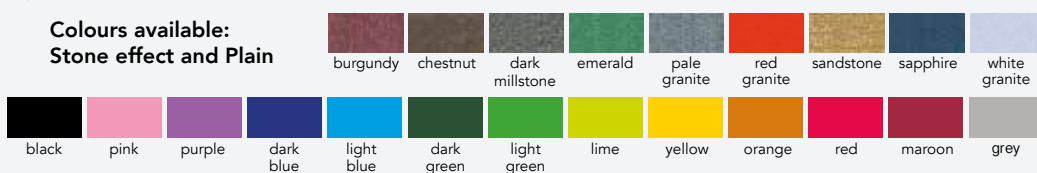

FEATURES

- Polyethylene bodyshell
- Two galvanised steel liners (Can be supplied with plastic liner if preferred)
- Hygienic, easy to clean
- Environmentally friendly, made from recyclable plastic

All prices are subject to VAT but include delivery to any UK Mainland site. Deliveries to Northern Ireland and the Scottish Highlands add £15.00 + VAT per bin.



Popular Recycling Bins



FEATURES

- Polyethylene bodyshell
- Galvanised steel liner (Can be supplied with plastic if preferred)
- Hygienic, easy to clean
- Environmentally friendly, made from recyclable plastic

Code	Product	Height	Diameter	Capacity	Weight	Price
POP-RCH	Bin with recycling character	790mm	390mm	70L	10.2kg	£168.25
POP-RCH4	Bin with recycling character x 4	"	"	"	"	£657.00
*GFB	Ground fixing bolts per bin	-	-	-	-	£14.00

*optional extra

- CHOOSE FROM: • FRUIT • CANS • PAPER • PLASTIC BOTTLES • COMPOST • GENERAL WASTE • MIXED RECYCLING • CARDBOARD • GLASS BOTTLES • MILK CARTONS

All prices are subject to VAT but include delivery to any UK Mainland site. Deliveries to Northern Ireland and the Scottish Highlands add £15.00 + VAT per bin.

Classic Recycling Bins



C-R £219.75 per bin

Slimline Classic Recycling Bins



SC-R £184.50 per bin

CHOOSE FROM: • CANS • FRUIT
 • PAPER • PLASTIC • BOTTLES
 • ORGANIC WASTE • FRUIT
 • CARDBOARD • BATTERIES
 • SILVER FOIL

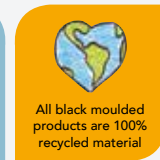

Please choose colour and message

FEATURES

- Polyethylene bodyshell
- Galvanised steel liner (Can be supplied with plastic liner if preferred)
- Lock and key
- Hygienic, easy to clean
- Environmentally friendly, made from recyclable plastic

Code	Product	Height	Diameter	Capacity	Weight	Price
C-R	Bin with recycling wording	1130mm	520mm	90L	23.2kg	£219.75
C-R-4	Bin with recycling wording set of 4					£859.00
SC-R	Bin with recycling wording	940mm	390mm	52L	10.5kg	£184.50
SC-R-4	Bin with recycling wording set of 4					£722.00
*GFB	Ground fixing bolts per bin	-	-	-	-	£14.00

*optional extra

All prices are subject to VAT but include delivery to any UK Mainland site. Deliveries to Northern Ireland and the Scottish Highlands add £15.00 + VAT per bin.



Wall-Post Mounted Litter Bin



Code	Product	Height	Width	Depth	Capacity	Weight	Price
WPM	Single bin	675mm	440mm	310mm	26L	28kg	£141.75

Optional Extras **BKPM** banding kit and tool for post mounting (25 bins) £153.00
BPM banding and seals only (25 bins) £77.50

FEATURES

- Polyethylene bodyshell
- Hygienic, easy to clean
- Made from recyclable plastic
- Wall or post mounting
- Environmentally friendly, made from recyclable plastic
- Lock and key
- Internal galvanised steel liner
- Wall fixing bolts supplied

Colours available: Stone effect and Plain



All prices are subject to VAT but include delivery to any UK Mainland site. Deliveries to Northern Ireland and the Scottish Highlands add £15.00 + VAT per bin.

Large and Standard Grit Bin

Available in yellow only



FEATURES

- Polyethylene bodyshell
- Fork lift truck grooves for easy handling
- Hygienic, easy to clean
- Environmentally friendly, made from recyclable plastic

Optional Extra: Hasp, staple and padlock £35.00

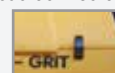

Code	Product	Height	Length	Depth	Capacity	Weight	Price
GB-S	Standard Grit Bin	710mm	840mm	500mm	200L	11.5	£166.25
GB-L	Large Grit Bin	920mm	1050mm	670mm	400L	18.5	£207.00

All prices are subject to VAT but include delivery to any UK Mainland site. Deliveries to Northern Ireland and the Scottish Highlands add £15.00 + VAT per bin.



GB-S £166.25



Meeting Point Table



FEATURES

- Made from polyethylene
- Hygienic, easy to clean
- Environmentally friendly, made from recyclable plastic
- Ground fixing bolts for hard surfaces

Code	Product	Height	Length	Depth	Weight	Price
MPT	Single table	1060mm	635mm	600mm	28kg	£254.00
SPT	With ashtray					£291.75

Colours available: Stone effect

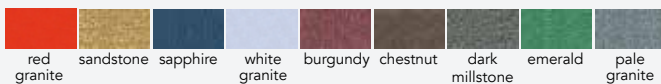

Please note that all struts are made from 100% recycled material and are available in black only.

All prices are subject to VAT but include delivery to any UK Mainland site. Deliveries to Northern Ireland and the Scottish Highlands add £20.00 + VAT per bench.

Wooden Picnic Table



FEATURES

- Preserved treated timbers from sustainable renewable sources
- Heavy duty for outdoor use
- Supplied flat pack for self assembly

	Product	Height	Length	Depth	Weight	Price
PPT-6	6 person set	760mm	1355mm	1490mm	28kg	£296.75
PPT-8	8 person set	760mm	1615mm	1490mm	30kg	£307.00

Disabled access add £15.00



Modular Seating



emerald

MSF-3 £448.75

MSF-4 £746.00



MSP-4 £746.00

sapphire

FEATURES

- Extremely versatile - limitless combination of seating arrangements
- Maintenance free - no need for varnish or paint
- Ground fixing bolts supplied for hard surfaces
- Hygienic, easy to clean
- Environmentally friendly, made from recycled and recyclable plastic
- Vandal resistant - made from durable polyethylene
- Struts are supplied in black only and are 100% recycled material

Please note some simple self assembly is required with this product.

Suggested Arrangements

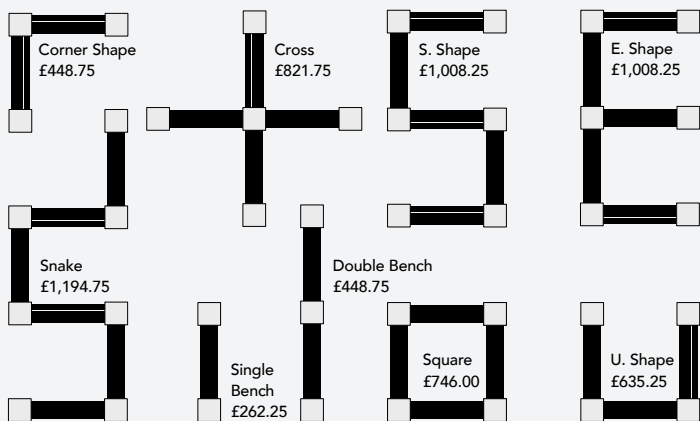

FOR ALTERNATIVE PERSONALISED LAYOUTS PLEASE CALL FOR PRICE

Dimensions

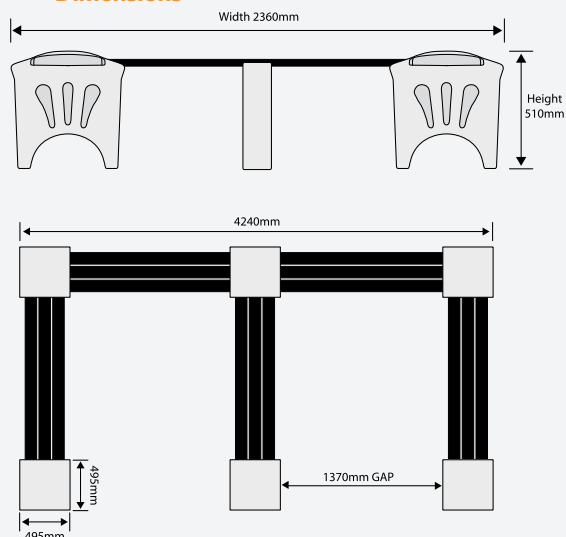

Modular Seating



sapphire

MSF-4U £635.25

Colours available:
Stone effect and Plain



Unit Shape	Modular with Flat Top Box Code	Modular with Planter Box Code	Price	optional extra Earth Fixing Kit for grass	Price
Single Bench	MSF-2	MSP-2	£262.25	EK	£58.25
Double Bench	MSF-3	MSP-3	£448.75	EK	£97.25
Corner Shape	MSF-3	MSP-3	£448.75	EK	£97.25
U-Shape	MSF-4U	MSP-4U	£635.25	EK	£97.25
Square	MSF-4	MSP-4	£746.00	EK	£97.25
Cross	MSF-5	MSP-5	£821.75	EK	£119.75
S-Shape	MSF-6	MSP-6	£1,008.25	EK	£153.25
E-Shape	MSF-6	MSP-6	£1,008.25	EK	£153.25
Snake	MSF-7	MSP-7	£1,194.75	EK	£153.25

Please note that ground fixing bolts for **HARD SURFACES** are included in the price. An earth fixing kit for **GRASS** is available as an optional extra.

All prices are subject to VAT but include delivery to any UK Mainland site. Deliveries to Northern Ireland and the Scottish Highlands add £55.00 + VAT per product.

Weights

Each end box 6kg
Each end box + strut + centre support 26kg



Example of a personalised arrangement.



Junior Jigsaw Table Set

Junior Jigsaw Table Set (4 Children)



COLOURS MAY VARY

Please note that all struts are made from 100% recycled material and are available in black only.



JJGTS £305.00

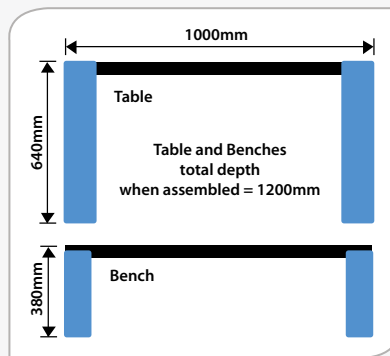

Code	Product	Capacity	Weight	Price
JJGTS	Table + bench set	4 children	67kg	£305.00
*EKT	Earth fixing kit for grass	-	-	£119.75

*optional extra

Please note that ground fixing bolts for HARD SURFACES are included in the price. An earth fixing kit for GRASS is available as an optional extra.

PLEASE NOTE: SOME SIMPLE SELF ASSEMBLY IS REQUIRED WITH THIS PRODUCT

FEATURES

- Maintenance free
- Ready assembled
- Ground fixing bolts for hard surfaces
- Environmentally friendly, made from recyclable plastic
- Hygienic, easy to clean
- Vandal resistant
- UV stable

All prices are subject to VAT but include delivery to any UK Mainland site. Deliveries to Northern Ireland and the Scottish Highlands add £35.00 + VAT per set.

Junior Table Set

Junior Table Set (4 Children)



COLOURS MAY VARY

Please note that all struts are made from 100% recycled material and are available in black only.



JTS £305.00

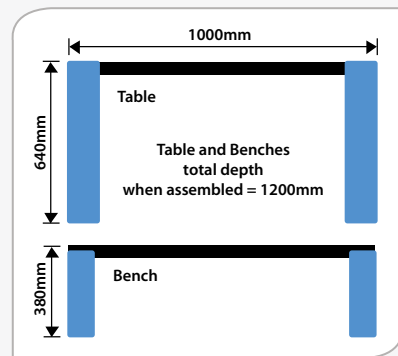

Code	Product	Capacity	Weight	Price
JTS	Table + bench	4 children	63kg	£305.00
*EKT	Earth fixing kit for grass	-	-	£119.75

*optional extra

Please note that ground fixing bolts for HARD SURFACES are included in the price. An earth fixing kit for GRASS is available as an optional extra.

PLEASE NOTE: SOME SIMPLE SELF ASSEMBLY IS REQUIRED WITH THIS PRODUCT

FEATURES

- Maintenance free
- Environmentally friendly, made from recyclable plastic
- Hygienic, easy to clean
- Vandal resistant
- UV stable
- Ground fixing bolts for hard surfaces

All prices are subject to VAT but include delivery to any UK Mainland site. Deliveries to Northern Ireland and the Scottish Highlands add £35.00 + VAT per set.



Multicoloured Zigzag Bench

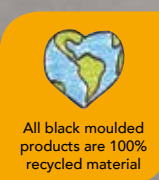
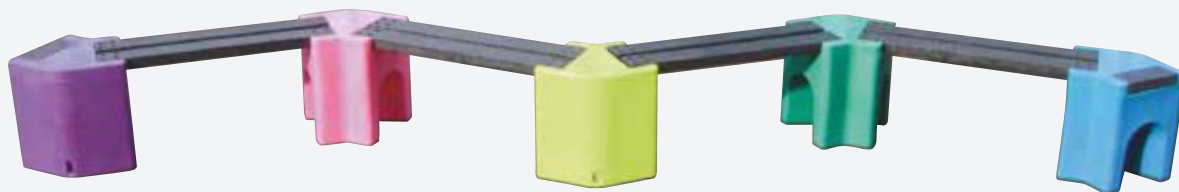

PLEASE NOTE: SOME SIMPLE SELF ASSEMBLY IS REQUIRED WITH THIS PRODUCT



ZZ-14 £550.25

ZZ-10 £405.00

ZZ-6 £249.75

FEATURES

- Extremely versatile - limitless combination of seating arrangements
- Maintenance free - no need for varnish or paint
- Ground fixing bolts supplied for hard surfaces
- Hygienic, easy to clean
- Environmentally friendly, made from recycled and recyclable plastic
- Vandal resistant - made from durable polyethylene
- Struts are supplied in black only and are 100% recycled material

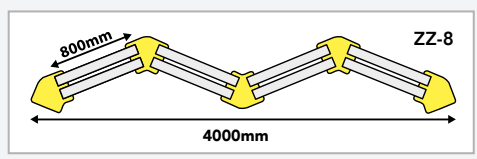

Code	Product	Height	Length	Depth	Weight	Price
ZZ-4	4 person unit	380mm	2160mm	650mm	27kg	£205.25
ZZ-6	6 person unit	380mm	3080mm	650mm	38kg	£249.75
ZZ-8	8 person unit	380mm	4000mm	650mm	49kg	£327.25
ZZ-10	10 person unit	380mm	4920mm	650mm	60kg	£405.00
ZZ-12	12 person unit	380mm	5840mm	650mm	71kg	£482.75
ZZ-14	14 person unit	380mm	6760mm	650mm	82kg	£550.25
*EK	Earth fixing kit (4 person)	-	-	-	-	£97.25
*EK	Earth fixing kit (6 person)	-	-	-	-	£97.25
*EK	Earth fixing kit (8 person)	-	-	-	-	£119.75
*EK	Earth fixing kit (10 person)	-	-	-	-	£119.75
*EK	Earth fixing kit (12 person)	-	-	-	-	£153.25
*EK	Earth fixing kit (14 person)	-	-	-	-	£153.25

*optional extra

Please note: Units are supplied in standard plain colours. Please ask if specific colours are required.

Please note that all struts are made from 100% recycled material and are available in black only.

Please note that ground fixing bolts for HARD SURFACES are included in the price. An earth fixing kit for GRASS is available as an optional extra.

All prices are subject to VAT but include delivery to any UK Mainland site. Deliveries to Northern Ireland and the Scottish Highlands add £35.00 + VAT per product.

Multicoloured Spiral Bench



SPI-24 £919.00

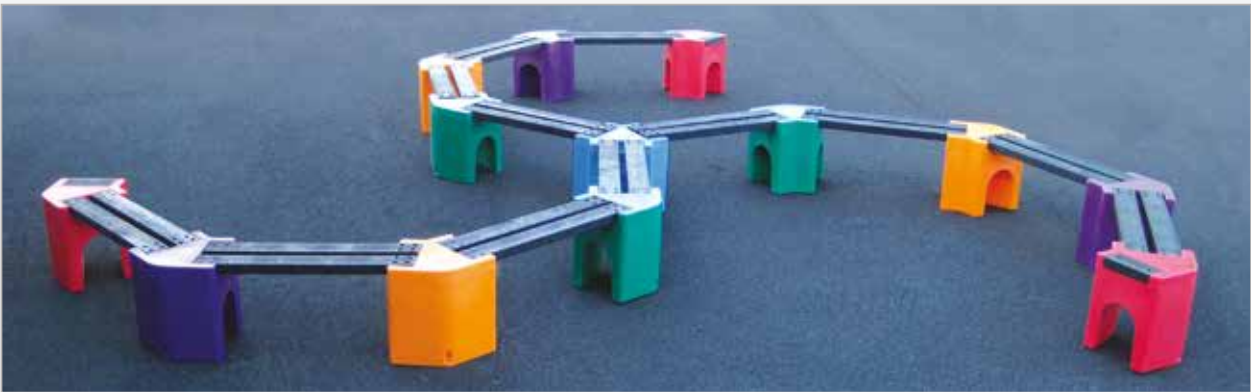

PLEASE NOTE: SOME SIMPLE SELF ASSEMBLY IS REQUIRED WITH THIS PRODUCT

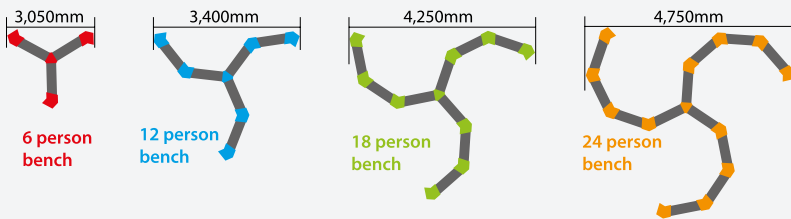

FEATURES

- Maintenance free - no need for varnish or paint
- Ground fixing bolts for hard surfaces
- Environmentally friendly, made from recyclable plastic
- Hygienic, easy to clean
- Vandal resistant - made from durable polyethylene
- UV stable
- Struts are supplied in black only and are 100% recycled material

Code	Product	Height	Length	Depth	Weight	Price
SPI-6	6 person unit	380mm	3050mm	3050mm	38kg	£269.50
SPI-12	12 person unit	380mm	3400mm	3400mm	71kg	£470.75
SPI-18	18 person unit	380mm	4250mm	4250mm	104kg	£691.75
SPI-24	24 person unit	380mm	4750mm	4750mm	137kg	£919.00
*EK	Earth fixing kit (6 person)	-	-	-	-	£119.75
*EK	Earth fixing kit (12 person)	-	-	-	-	£119.75
*EK	Earth fixing kit (18 person)	-	-	-	-	£174.75
*EK	Earth fixing kit (24 person)	-	-	-	-	£226.25

*optional extra

Please note: Units are supplied in standard plain colours. Please ask if specific colours are required.

Please note that all struts are made from 100% recycled material and are available in black only.



Please note that ground fixing bolts for HARD SURFACES are included in the price. An earth fixing kit for GRASS is available as an optional extra.

All prices are subject to VAT but include delivery to any UK Mainland site. Deliveries to Northern Ireland and the Scottish Highlands add £35.00 + VAT per product.



Multicoloured Learning Curve



FEATURES

- UV stable
- Vandal resistant
- Maintenance free
- Hygienic, easy to clean
- Ground fixing bolts for hard surfaces
- Environmentally friendly, made from recyclable plastic

Code	Product	Height	Width	Capacity	Weight	Price
LC-1	Single unit	380mm	2,600mm	12+ children	71kg	£468.75
LC-2	Double unit	380mm	2,600mm x 2	24+ children	71kg x 2	£856.25
LC-3	Triple unit	380mm	2,600mm x 3	36+ children	71kg x 3	£1,243.75
LC-T	Single unit + chair	380mm	2,600mm	12+ children	71kg	£575.75
LLC	Large single unit	380mm	4,050mm	18+ children	92kg	£665.75
LLC-T	Large single unit + chair	380mm	4,050mm	18+ children	92kg	£772.75
*EK-LC	Earth fixing kit per unit	-	-	-	-	£119.75
*EK-LLC	Earth fixing kit per unit	-	-	-	-	£119.75

*optional extra

Please note that ground fixing bolts for **HARD SURFACES** are included in the price. An earth fixing kit for **GRASS** is available as an optional extra.

All prices are subject to VAT but include delivery to any UK Mainland site. Deliveries to Northern Ireland and the Scottish Highlands add £45.00 + VAT per set.

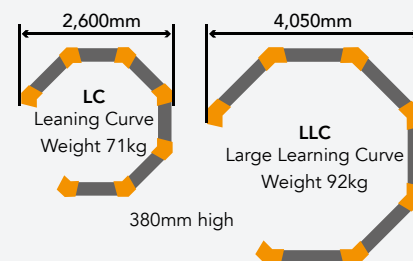

Please note that all struts are made from 100% recycled material and are available in black only.

Multicoloured Learning Arena

LA £1077.00



Teachers Chair

Please note: Units are supplied in standard plain colours. Please ask if specific colours are required.

Please note that all struts are made from 100% recycled material and are available in black only.



Multi-coloured Learning Arena with Teachers Chair



LA-T £1,184.25

30+ children

PLEASE NOTE: SOME SIMPLE SELF ASSEMBLY IS REQUIRED WITH THIS PRODUCT

FEATURES

- UV stable
- Vandal resistant
- Maintenance free
- Hygienic, easy to clean
- Ground fixing bolts for hard surfaces
- Environmentally friendly, made from recyclable plastic

Code	Product	Height	Width	Capacity	Weight	Price
LA	Arena	380mm	4,050mm	30+ children	163kg	£1,077.00
LA-T	Arena + chair	380mm	4,050mm	30+ children	195kg	£1,184.25
*EK-LA	Earth Fixing Kit (Grass)	-	-	-	-	£233.50

*optional extra

Please note that ground fixing bolts for **HARD SURFACES** are included in the price. An earth fixing kit for **GRASS** is available as an optional extra.

All prices are subject to VAT but include delivery to any UK Mainland site. Deliveries to Northern Ireland and the Scottish Highlands add £45.00 + VAT per set.

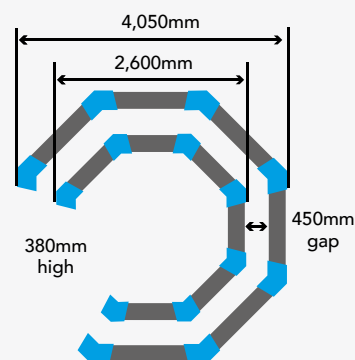



All products made in the uk

Jigsaw Table and Bench Sets



JTB-6 £684.50



JTB-8 £715.00

COLOURS MAY VARY

Please note that all struts are made from 100% recycled material and are available in black only.

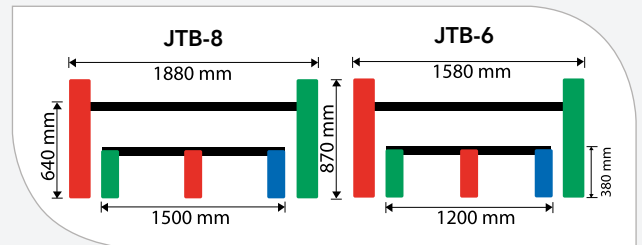

Assembled width approx 1.4m



JB-3 £235.50



JB-4 £245.75

Code	Product	Capacity	Weight	Price
JTB-6	Table + 2 x 3 person bench	6 children	98kg	£684.50
JTB-8	Table + 2 x 4 person bench	8 children	108kg	£715.00
*EK-T	Earth fixing kit for grass (table set)	-	-	£119.75
JB-3	3 person bench	3 children	18kg	£235.50
JB-4	4 person bench	4 children	20kg	£245.75
*EK	Earth fixing kit for grass (bench)	-	-	£58.25

*optional extra

Please note that ground fixing bolts for HARD SURFACES are included in the price. An earth fixing kit for GRASS is available as an optional extra.

FEATURES

- Maintenance free
- Ready assembled
- Ground fixing bolts for hard surfaces
- Environmentally friendly, made from recyclable plastic
- Hygienic, easy to clean
- Vandal resistant
- UV stable

All prices are subject to VAT but include delivery to any UK Mainland site. Deliveries to Northern Ireland and the Scottish Highlands add £20.00 + VAT per bench or table.



Star Bench

6 Person Bench



ST-6 £330.50

8 Person Bench



ST-8 £345.75



ST-6 £330.50



ST-8 £345.75

sapphire



Code	Product	Height	Length	Depth	Weight	Price
ST-6	6 person bench	710mm	1760mm	720mm	60kg	£330.50
ST-8	8 person bench	710mm	2015mm	720mm	65kg	£345.75
*EK	Earth fixing kit for grass	-	-	-	-	£58.25

*optional extra

Please note that ground fixing bolts for HARD SURFACES are included in the price. An earth fixing kit for GRASS is available as an optional extra.

FEATURES

- Maintenance free
- Ready assembled
- Ground fixing bolts for hard surfaces
- Environmentally friendly, made from recyclable plastic
- Hygienic, easy to clean
- Vandal resistant
- UV stable

All prices are subject to VAT but include delivery to any UK Mainland site. Deliveries to Northern Ireland and the Scottish Highlands add £20.00 + VAT per product.

All products are available in Stone Effect, Plain and Multi-coloured (assorted plain colours)

Please note that all struts are made from 100% recycled material and are available in black only.

Colours available: Stone effect and Plain



Premier Double-Sided Seats

6 Person Seat



sapphire

6 Person Seat



DSS-6 £376.50

dark millstone

8 Person Seat



DSS-8 £391.75

burgundy

8 Person Seat



red granite

All black moulded products are 100% recycled material

Code	Product	Height	Length	Depth	Weight	Price
DSS-6	6 person seat	800mm	1775mm	900mm	85kg	£376.50
DSS-8	8 person seat	800mm	1975mm	900mm	93kg	£391.75
*EK	Earth fixing kit for grass	-	-	-	-	£58.25

*optional extra

Please note that ground fixing bolts for **HARD SURFACES** are included in the price. An earth fixing kit for **GRASS** is available as an optional extra.

FEATURES

- Maintenance free
- Ready assembled
- Ground fixing bolts for hard surfaces
- Environmentally friendly, made from recyclable plastic
- Hygienic, easy to clean
- Vandal resistant
- UV stable

All prices are subject to VAT but include delivery to any UK Mainland site. Deliveries to Northern Ireland and the Scottish Highlands add £20.00 + VAT per product.

Colours available: Stone effect and Plain

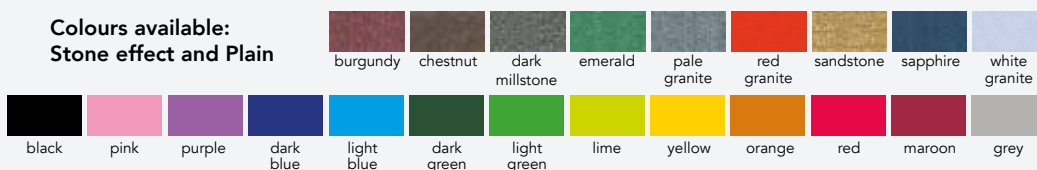

All products are available in Stone Effect, Plain and Multi-coloured (assorted plain colours)

Please note that all struts are made from 100% recycled material and are available in black only.

Wall Mounted Seats and Benches

Wall Mounted Seat

3 Person Seat



4 Person Seat



Wall Mounted Bench



Code	Product	Height	Length	Depth	Weight	Price
WSE-3	3 person seat	800mm	1775mm	485mm	46kg	£269.25
WSE-4	4 person seat	800mm	1975mm	485mm	50kg	£294.75
WB	Wall bench	-	2050mm	320mm	19.5kg	£188.75

All prices are subject to VAT but include delivery to any UK Mainland site. Deliveries to Northern Ireland and the Scottish Highlands add £20.00 + VAT per product.

FEATURES

- Maintenance free
- Ready assembled
- Wall fixing bolts
- Environmentally friendly, made from recyclable plastic
- Hygienic, easy to clean
- Vandal resistant
- UV stable

Colours available: Stone effect and Plain



All products are available in Stone Effect, Plain and Multi-coloured (assorted plain colours)

Please note that all struts are made from 100% recycled material and are available in black only.

Multicoloured Bench

2 Person Bench



PB-2 £227.50

3 Person Bench



PB-3 £263.25

4 Person Bench



PB-4 £288.75



Code	Product	Height	Length	Depth	Weight	Price
PB-2	2 person bench	410mm	1250mm	560mm	26kg	£227.50
PB-3	3 person bench	410mm	1850mm	560mm	37kg	£263.25
PB-4	4 person bench	410mm	2050mm	560mm	45kg	£288.75
*EK	Earth fixing kit for grass	-	-	-	-	£58.25

*optional extra

Please note that ground fixing bolts for HARD SURFACES are included in the price. An earth fixing kit for GRASS is available as an optional extra.

FEATURES

- Maintenance free
- Ready assembled
- Ground fixing bolts for hard surfaces
- Environmentally friendly, made from recyclable plastic
- Hygienic, easy to clean
- Vandal resistant
- UV stable

All prices are subject to VAT but include delivery to any UK Mainland site. Deliveries to Northern Ireland and the Scottish Highlands add £20.00 + VAT per product.

Colours available: Stone effect and Plain



All products are available in Stone Effect, Plain and Multi-coloured (assorted plain colours)

Please note that all struts are made from 100% recycled material and are available in black only.

Premier Stone Effect Bench

2 Person Bench



4 Person Bench



3 Person Bench



4 Person Bench



3 Person Bench



Multicoloured Seat

2 Person Seat



PS-2 £274.50

3 Person Seat



PS-3 £310.00



4 Person Seat



PS-4 £335.50



Code	Product	Height	Length	Depth	Weight	Price
PS-2	2 person seat	840mm	1350mm	620mm	48kg	£274.50
PS-3	3 person seat	840mm	1850mm	620mm	64kg	£310.00
PS-4	4 person seat	840mm	2050mm	620mm	75kg	£335.50
*EK	Earth fixing kit for grass	-	-	-	-	£58.25

*optional extra

Please note that ground fixing bolts for **HARD SURFACES** are included in the price. An earth fixing kit for **GRASS** is available as an optional extra.

FEATURES

- Maintenance free
- Ready assembled
- Ground fixing bolts for hard surfaces
- Environmentally friendly, made from recyclable plastic
- Hygienic, easy to clean
- Vandal resistant
- UV stable

All prices are subject to VAT but include delivery to any UK Mainland site. Deliveries to Northern Ireland and the Scottish Highlands add £20.00 + VAT per product.

Colours available: Stone effect and Plain

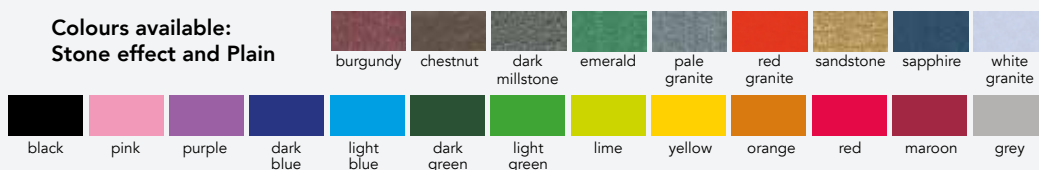

All products are available in Stone Effect, Plain and Multi-coloured (assorted plain colours)

Please note that all struts are made from 100% recycled material and are available in black only.

Premier Stone Effect Seat

3 Person Seat



4 Person Seat



2 Person Seat



3 Person Seat



3 Person Seat



Multicoloured Table and Bench Sets

Table



PT £428.50

8 Person Bench Set



PTB-8 £850.75

6 Person Bench Set



PTB-6 £784.50

Dimensions	Height	Length	Depth	Weight
3 person bench	410mm	1850mm	560mm	37kg
4 person bench	410mm	2050mm	560mm	45kg
Table	720mm	2050mm	680mm	67kg

Code	Product	Price
PTB-6	2 x 3 person bench + table	£784.50
PTB-8	2 x 4 person bench + table	£850.75
PT	Table only	£428.50
*EKT	Earth fixing kit for grass	£119.75

*optional extra

Please note that ground fixing bolts for HARD SURFACES are included in the price. An earth fixing kit for GRASS is available as an optional extra.

All prices are subject to VAT but include delivery to any UK Mainland site. Deliveries to Northern Ireland and the Scottish Highlands add £60.00 + VAT per set. For disabled access add £25.00 per set.

FEATURES

- Maintenance free
- Ready assembled
- Ground fixing bolts for hard surfaces
- Environmentally friendly, made from recyclable plastic
- Hygienic, easy to clean
- Vandal resistant
- UV stable



All products are available in Stone Effect, Plain and Multi-coloured (assorted plain colours)

Please note that all struts are made from 100% recycled material and are available in black only.

Colours available: Stone effect and Plain

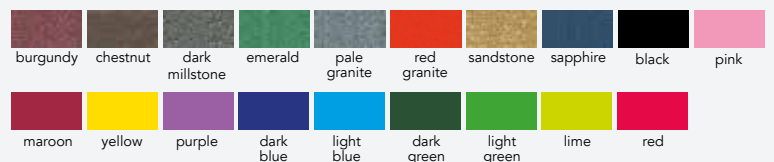

Premier Table and Bench Sets

6 Person Bench Set



PTB-6 £784.50

burgundy

8 Person Bench Set



PTB-8 £850.75

dark millstone

6 Person Bench Set



PTB-6 £784.50

sapphire



sandstone

Please note that sets are available with wheelchair access.

6 Person Bench Set



PTB-6 £784.50

emerald



Premier Table and Seat Sets

6 Person Seat Set



PTS-6 £943.50

sandstone

6 Person Seat Set



PTS-6 £943.50

sapphire

8 Person Seat Set



PTS-8 £1,004.75

emerald

Dimensions	Height	Length	Depth	Weight
3 person seat	840mm	1850mm	620mm	64kg
4 person seat	840mm	2050mm	620mm	75kg
Table	720mm	2050mm	620mm	67kg

Code	Product	Price
PTS-6	2 x 3 person seat + table	£943.50
PTS-8	2 x 4 person seat + table	£1,004.75
PT	Table only	£428.50
*EKT	Earth fixing kit for grass	£119.75

*optional extra

Please note that ground fixing bolts for **HARD SURFACES** are included in the price. An earth fixing kit for **GRASS** is available as an optional extra.

All prices are subject to VAT but include delivery to any UK Mainland site. Deliveries to Northern Ireland and the Scottish Highlands add £60.00 + VAT per set. For disabled access add £25.00 per set.

FEATURES

- Maintenance free
- Ready assembled
- Ground fixing bolts for hard surfaces
- Environmentally friendly, made from recyclable plastic
- Hygienic, easy to clean
- Vandal resistant
- UV stable

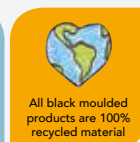

All products are available in Stone Effect, Plain and Multi-coloured (assorted plain colours)

Please note that all struts are made from 100% recycled material and are available in black only.

Colours available: Stone effect and Plain

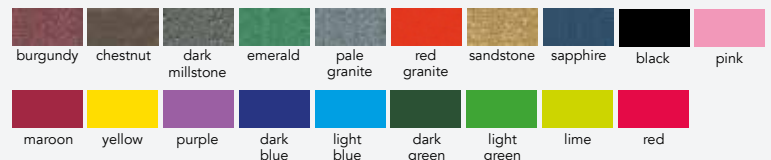

Planters

Ornamental Planter



Square Planter



FEATURES

- Maintenance free - will not rust, no painting required
- Environmentally friendly, made from recyclable plastic
- Hygienic, easy to clean
- Vandal resistant
- UV stable

All prices are subject to VAT but include delivery to any UK Mainland site. Deliveries to Northern Ireland and the Scottish Highlands add £15.00 + VAT per product. There is a £15.00 delivery charge for all orders under £100.00.

Code	Product	Height	Width	Depth	Weight	Price
SP	Square Planter	700mm	550mm	550mm	12kg	£116.25
SP-4	Square Planter x 4	-	-	-	-	£445.00
OP	Ornamental Planter	640mm	500mm	500mm	6kg	£99.00
OP-4	Ornamental Planter x 4	-	-	-	-	£380.00
*GFB	Ground Fixing Bolts per planter	-	-	-	-	£14.00

*optional extra

Colours available: Stone effect and Plain



Multi-Purpose Lockers

The 'Lockers' are ideal for use in all types of environments including, hospitals, schools, colleges, universities, sports centres and many other industries which have a need for secure storage. They can be sited to effectively utilise available space both indoors and outdoors.

The 'Jumbo Locker' enables the storage of outsize items such as sports and training equipment, cricket and hockey bags, tool boxes, musical instruments and many other items which can normally be found in unsecured area cluttering corridors and store rooms. The 'Large Locker' ensures that valuable out-sized items do not have to be carried around until required.

The two sizes available are: 1250mm deep x 550mm high x 550mm wide (Jumbo) or 700mm deep x 550mm high x 550mm wide (Large) and can be supplied as individual units or in multiple units to bolt together in banks.

All lockers are manufactured in hard wearing polyethylene which will not rust or require painting and are weather and vandal resistant which makes them ideal for outdoor use.

The products can be supplied with different coloured bodies and doors to meet any colour-coded requirements.

The lockers are hygienic and easy to clean and are made from recycled and recyclable material. (All black moulded products are made from 100% recycled material).

The units can be supplied with either a padlock, or an integral keyed handle. Master keys are available with padlock only if required. Keyed handles can be supplied either 'keyed differently' or 'keyed alike' but not with master key.

Large Lockers

Code	Product	Height	Length	Depth	Weight	Price
LMPL-P	Single Large locker with padlock	550mm	550mm	700mm	16kg	£198.25
LMPL-P	2 to 5 units	-	-	-	-	£189.50
LMPL-P	6 to 10 units	-	-	-	-	£180.75
LMPL-P	11 or more units	-	-	-	-	£172.00
LMPL-K	Single Large locker with keyed handle	550mm	550mm	700mm	16kg	£198.25
LMPL-K	2 to 5 units	-	-	-	-	£189.50
LMPL-K	6 to 10 units	-	-	-	-	£180.75
LMPL-K	11 or more units	-	-	-	-	£172.00

FEATURES

- Maintenance free
- Ready assembled
- Environmentally friendly, made from recyclable plastic
- Hygienic, easy to clean
- Vandal resistant
- Padlock or Keyed handle
- UV stable

PLEASE STATE COLOUR AND PREFERRED LOCK WHEN ORDERING.

Jumbo Lockers

Code	Product	Height	Length	Depth	Weight	Price
JMPL-P	Single Jumbo locker with padlock	550mm	550mm	1250mm	22kg	£221.50
JMPL-P	2 to 5 units	-	-	-	-	£212.75
JMPL-P	6 to 10 units	-	-	-	-	£204.00
JMPL-P	11 or more units	-	-	-	-	£195.25
JMPL-K	Single Jumbo locker with keyed handle	550mm	550mm	1250mm	22kg	£221.50
JMPL-K	2 to 5 units	-	-	-	-	£212.75
JMPL-K	6 to 10 units	-	-	-	-	£204.00
JMPL-K	11 or more units	-	-	-	-	£195.25

All prices are subject to VAT but include delivery to any UK Mainland site. Deliveries to Northern Ireland and the Scottish Highlands add £20.00 + VAT per product.



KEYED HANDLE



PADLOCK

Colours available: Stone effect and Plain

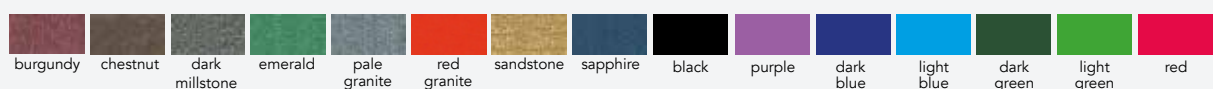

Jumbo Multi-Purpose Locker



sandstone

Large Multi-Purpose Locker



emerald



Cut-away view showing 380 litre Jumbo storage capacity



sandstone



purple

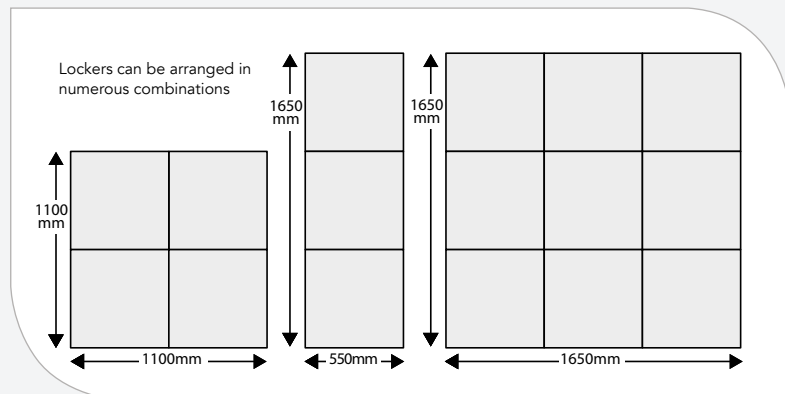

BykeBin Cycle Storage Unit



emerald



sandstone



sapphire



dark millstone



pale granite

BykeBins can be interlocking with access from either side as shown in (A) or bolted together in line (B). 6 units may be situated in 1 car parking space. Units can be bolted to the ground, but uplifted and relocated if necessary.

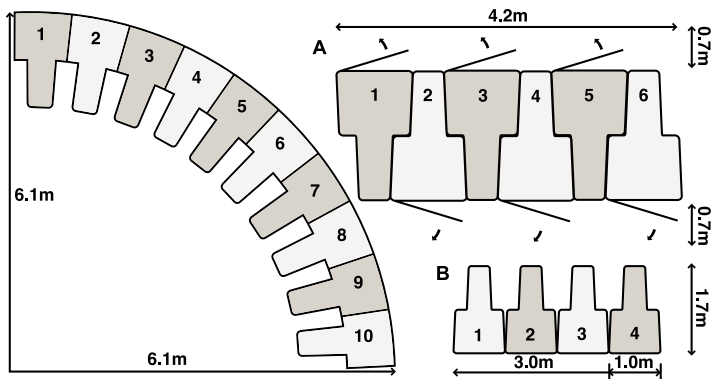

FEATURES

- Supplied assembled
- Padlock and key
- Padlock securing bracket
- Ground fixing bolts for hard surfaces
- Internal hooks for personal effects
- Internal ground fixing cycle securing positions
- Vandal resistant
- Huge advertising potential
- Can be installed in minutes
- Minimal maintenance - will not rust, no painting required
- Incorporates built-in floor
- Environmentally friendly, made from recyclable plastic
- Hygienic, easy to clean
- Drainage holes
- All metal work stainless steel



Colours available: Stone effect and Plain



Code	Product	Height	Width	Depth	Weight	Price
B	Bykebin	1250mm	960mm	1650mm	85kg	£628.25
BG	With advertising panel	1250mm	960mm	1650mm	85kg	£730.25
*BPCB	Padlock cover bracket	-	-	-	-	£29.50

*optional extra

All prices are subject to VAT but include delivery to any UK Mainland site. Deliveries to Northern Ireland and the Scottish Highlands add £60.00 + VAT per bykebin.

BykeBin Cycle Storage Unit

PERSONALISED GRAPHICS

The advertising/instruction panel can be manufactured with any personalised graphics. Our in-house designers will prepare computer illustrations for your approval free of charge.



1. Logo supplied by client



2. Presentation for customer approval



3. Finished product



chestnut



sandstone



*Padlock cover bracket
*optional extra



Theme Bins International Ltd

Established 1991

Sales Office

Theme Bins International Ltd
Knowl House,
84 Dale Street, Ossett, Wakefield,
West Yorkshire, WF5 9HJ
England
Tel: +44 (0) 844 8794154
Fax: +44 (0) 1924 270699
email: themebins@btconnect.com

Head Office

Theme Bins International Ltd,
Nest Road,
Felling Industrial Estate, Gateshead,
Tyne and Wear, NE10 OES
England
Tel: +44 (0) 191 4950772
Fax: +44 (0) 191 4694636
email: hq@themebins.co.uk

Approved Distributor



www.themebins.co.uk

