

7



EQUIPAMIENTO
COMERCIAL

ÉQUIPEMENT
COMMERCIAL

SHOPFITTING
EQUIPMENT

C R E A T I V I D A D
C R E A T I V I T É
I N N O V A T I O N

I N V E S T I G A C I O N
R E C H E R C H E
R E S E A R C H

D E S A R R O L L O
D É V E L O P P E M E N T
D E V E L O P M E N T

C A L I D A D
Q U A L I T É
Q U A L I T Y

S E R V I C I O
S E R V I C E

EDICION: ENERO 2014

CREACIONES MARSANZ, s.a. may change any product displayed in this catalogue without further notice. Partial or complete reproduction of this catalogue is also prohibited.

CREACIONES MARSANZ, s.a. se reserva el derecho de modificación, sin previo aviso, de todo el producto expuesto en el presente catálogo. Asimismo, queda prohibida la reproducción total o parcial del mismo.



















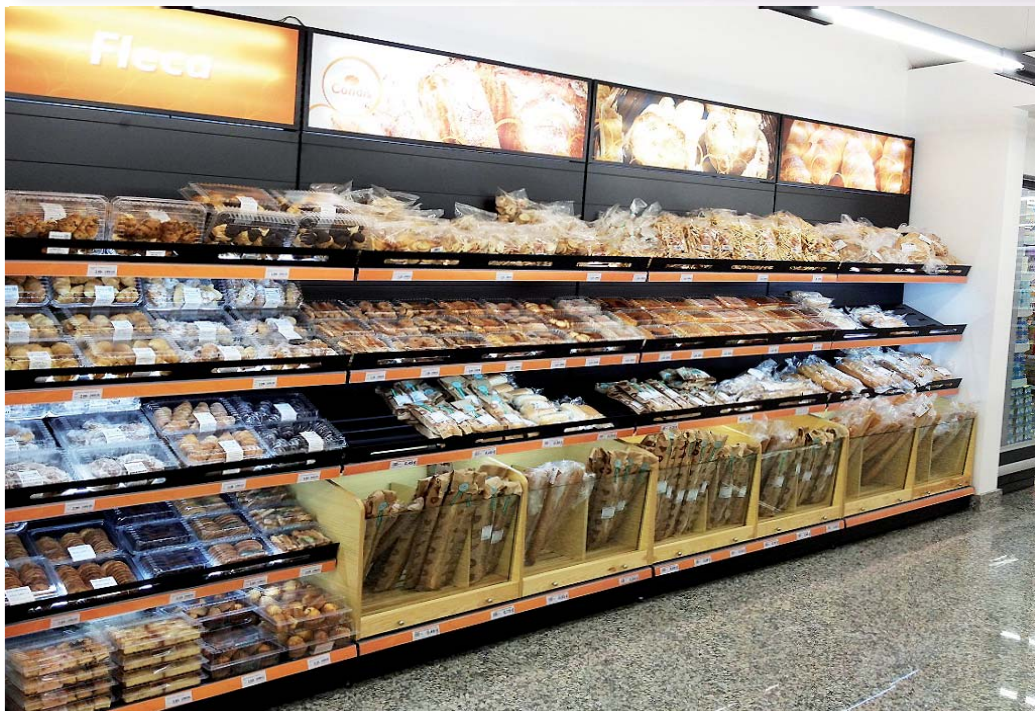







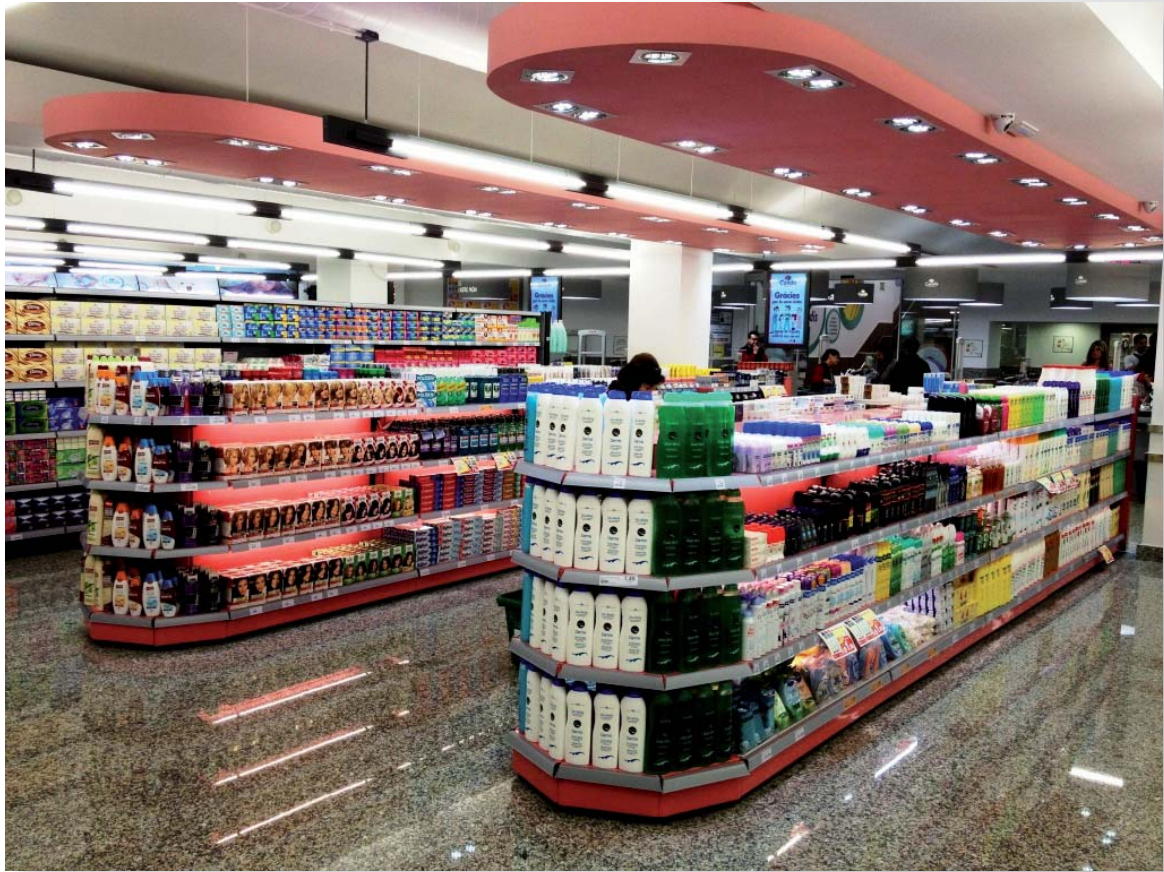









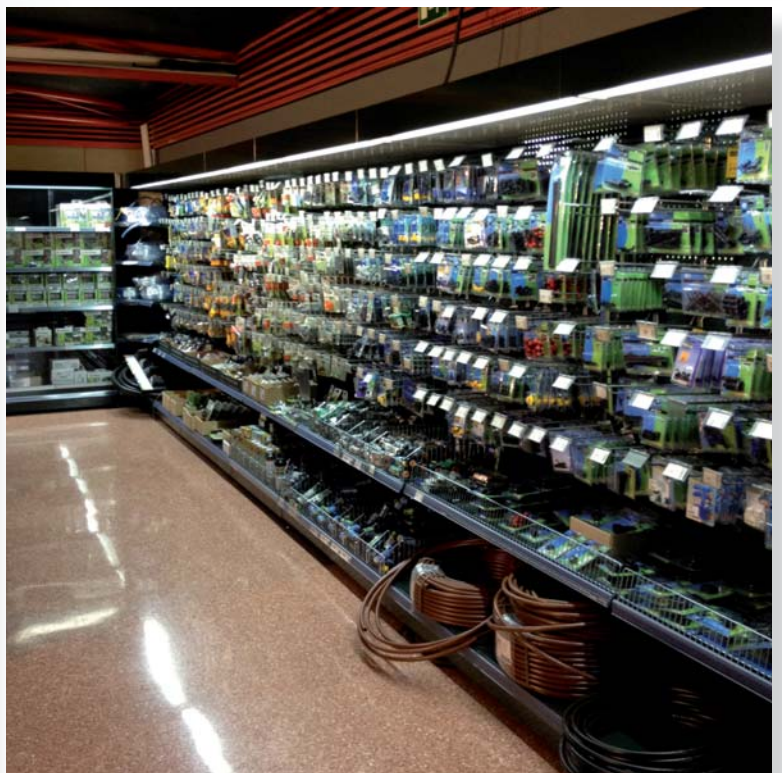







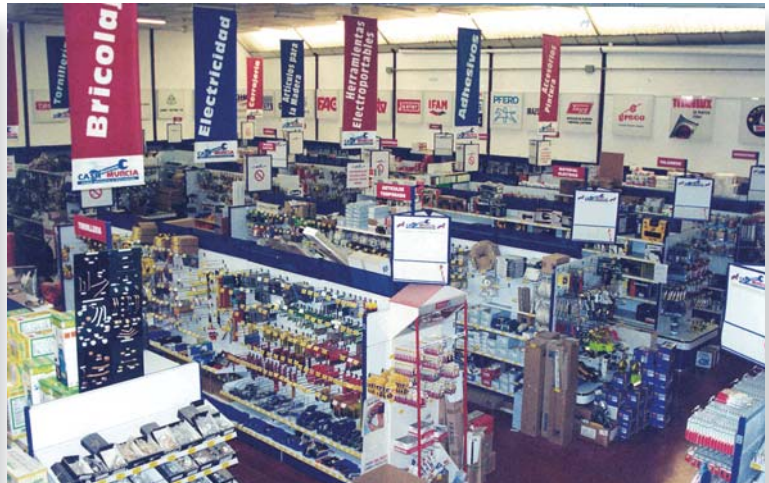











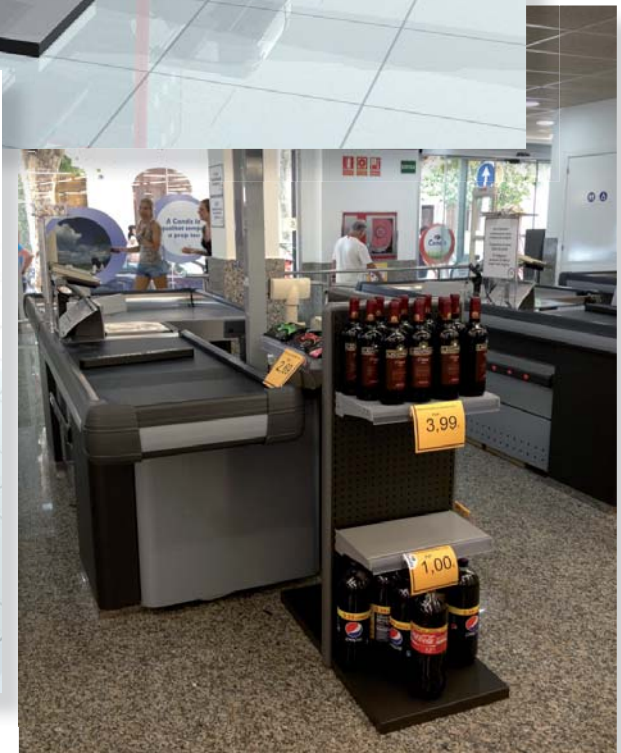
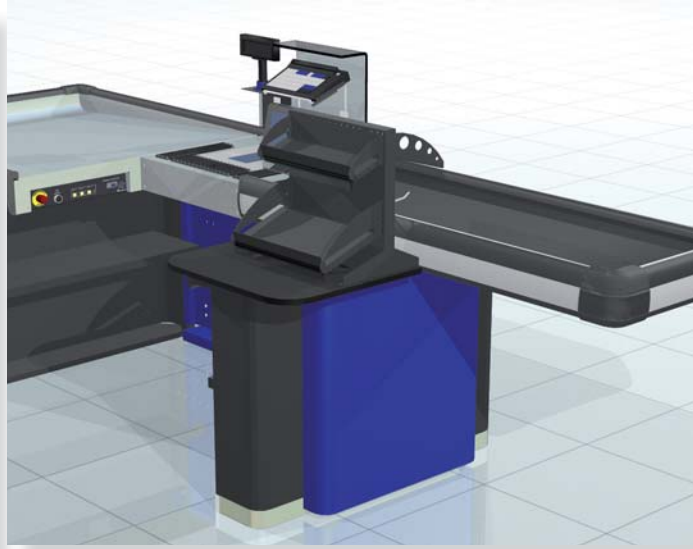
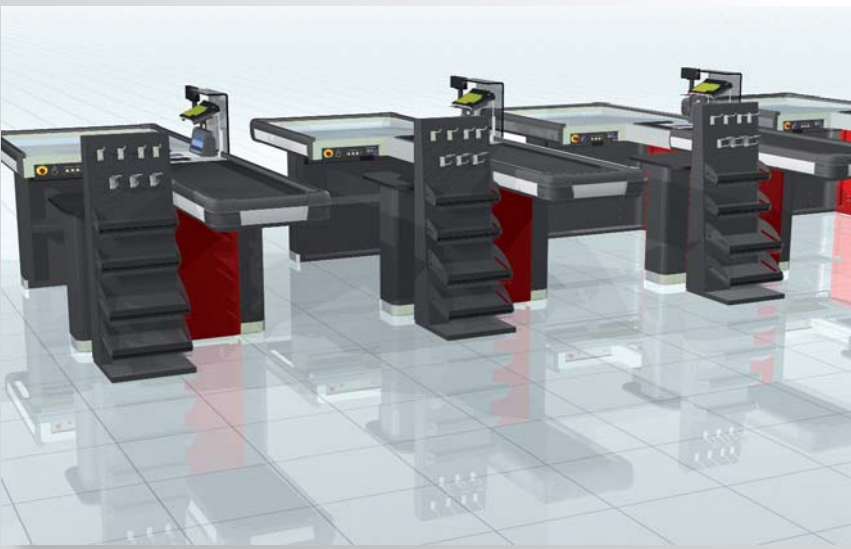



POLYSTEEL

NUEVO ESTILO
NOUVEAU STYLE
NEW STYLE

AENOR



Producto
Certificado

A12 / 000003

UNE-EN 1929-1
UNE-EN 1929-2
UNE-EN 1929-3
UNE-EN 1929-4
UNE-EN 1929-7
UNE-EN 4892-2



NUEVO CONCEPTO
NOUVEAU CONCEPT
NEW CONCEPT



NUEVA IMAGEN
NOUVELLE IMAGE
NEW IMAGE



DURABILIDAD
DURABILITÉ
DURABILITY





NUESTROS NUEVOS CARROS ESTAN
PREPARADOS PARA SATISFACER TODAS LAS EXIGENCIAS DEL NUEVO MERCADO.

OUR TROLLEYS ARE READY TO COMPLY WITH THE NEW MARKET DEMANDS



SU RESISTENCIA, ROBUSTEZ Y DURABILIDAD, HA LOGRADO HACER DE MARSANZ UNA MARCA DE REFERENCIA.

ITS RESISITANCE, STRONGHOLD AND DURABILITY HAS ACHIEVED MARSANZ A REFERENCED TRADEMARK.



OFRECIENDO UNA AMPLIA GAMA DE ACCESORIOS,
CONSEGUIMOS CUBRIR TODAS LAS NECESIDADES
EXIGIDAS POR NUESTROS CLIENTES

WE COVER ALL OF OUR CUSTOMER REQUEST OFFERING A WIDE RANGE OF ACCESSORIES



LOS NUEVOS DISEÑOS HACEN DE SU ENSAMBLAJE UNA NUEVA ESTETICA, MANIOBRABILIDAD, COLORIDO, MODERNIDAD. UN MAYOR DINAMISMO EN SU COMPRA.

EASY TO MOVE, WIDE RANGE OF COLOURS. THE NEW DESIGNS PROVIDES THE TROLLEY WITH A MODERN APPEARANCE



COMODIDAD Y SEGURIDAD
LA TRANQUILIDAD DEL PERFECTO ACABADO

SAFETY AND CONFORT: THE CALMNESS OF A PERFECT FINISHING



www.marsanz.es



SEDE SOCIAL
SIÈGE
HEAD OFFICE

CALLE HIERRO, 27
28850 TORREJON DE ARDOZ
MADRID
ESPAÑA - SPAIN

TEL.: (34) 91 675 14 34 // (34) 91 677 10 92
FAX.: (34) 91 675 12 90
E.MAIL.: creaciones@marsanz.es

PLANTAS DE FABRICACION
USINES
PRODUCTION FACILITIES

TORREJON DE ARDOZ (MADRID)
UGENA (TOLEDO)

INTERNACIONAL
INTERNATIONAL

EXPORT DIVISION

E.MAIL.: export@marsanz.es

FRANCIA
FRANCE

MARSANZ FRANCE SAS

13 RUE SAINT HONORÉ
78000 VERSAILLES

TEL.: +33 (0) 1 30 88 82 95
E.MAIL.: info@marsanz.fr
www.marsanz.fr

REINO UNIDO
UNITED KINGDOM

MARSANZ UK Ltd.

30 CHELSFIELD GROVE
MANCHESTER, M21 7SU

TEL.: +44 (0) 1618818515
E.MAIL.: info@marsanz.co.uk
www.marsanz.co.uk

DELEGACIONES EN ESPAÑA
BUREAUX REGIONAUX EN ESPAGNE
SPANISH BRANCHES

BARCELONA

POLIGONO INDUSTRIAL MOLI D'EN XECH
Calle Barneda, Nº 17 nave 25
Frente Rio Ripoll
08291 - RIPOLLET

TEL.: 93 231 34 75
FAX.: 93 231 35 47
E.MAIL.: barcelona@marsanz.es

SEVILLA

AVDA. DEL PARSÍ
POL.IND. MINI PARSÍ, NAVE 9
41016 SEVILLA

TEL.: 95 451 12 45
FAX.: 95 425 85 09
E.MAIL.: andalucia@marsanz.es

ALICANTE

C/ CAMPELLO, 13
POL.IND. LA CALA
03509 FINESTRAT - ALICANTE

TEL.: 96 680 27 04
FAX.: 96 683 07 96
E.MAIL.: levante@marsanz.es

DISTRIBUIDO POR

DISTRIBUÉ PAR

DISTRIBUTED BY

