

SERENITY WALL PANELS

MAKING YOUR INTERIOR QUIETER



movingdesigns LIMITED
movable and folding doors

Tel: 0845 643 2197

sales@movablewall.co.uk

Unit 5, Station Ind Est|Oxford Road|Wokingham|Berkshire|RG41 2YQ



SERENITY WALL PANELS ~ MAKING YOUR INTERIOR QUIETER

The Serenity is the perfect acoustic and aesthetic solution for various noise reducing applications. It decreases the reverberation time and absorbs sound in any space they are used. The wall panels are used extensively to transform areas such as multi-purpose halls, open-plan offices, conference suites, studios and interview rooms into workable environments.

FIRE RESISTANCE















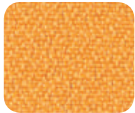





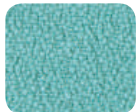
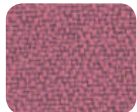

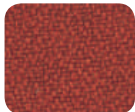

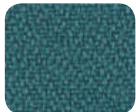

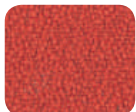

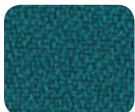









The recycled glasswool acoustic board provides very good fire-resistant properties. This is fire rated as Class 0 to BS476: Part 6. Standard fabric facings comply with Class 1 to BS476: Part 7. Class 0 fire rated fabric finishes are also available on request. UPVC trims are fire rated as BS476 Part 7.





STANDARD COLOUR CHART

































Lucia

 Adobo YB165 LR = 85.8	 Oyster YB107 LR = 64.8	 Turtle YB098 LR = 39.14	 Apple YB096 LR = 37.16	 Solano YB088 LR = 36.13	 Madura YB156 LR = 43.08	 Sandstorm YB302 LR = 22.78	 Reef YB085 LR = 45.6
 Aruba YB093 LR = 37.39	 Belize YB105 LR = 10.49	 Campeche YB301 LR = 27.43	 Bridgetown YB102 LR = 11.34	 Diablo YB101 LR = 6.99	 Jamaica YB027 LR = 7.2	 Calypso YB106 LR = 6.4	 Windjammer YB047 LR = 9.02
 Taboo YB045 LR = 4.15	 Tobago YB030 LR = 3.11	 Lobster YB087 LR = 11.55	 Tortuga YB168 LR = 30.46	 Montserrat YB011 LR = 7.94	 Arecibo YB099 LR = 45.31	 Bermuda YB084 LR = 32.9	 Mauve YB069 LR = 14.64
 Tarot YB090 LR = 3.01	 Ocean YB100 LR = 3.56	 Scuba YB089 LR = 6.37	 Bluebell YB097 LR = 16.91	 Martinique YB004 LR = 12.79	 Steel YB095 LR = 23.03	 Bluefield YB021 LR = 8.27	 Marianna YB157 LR = 33.48
 Tequila YB038 LR = 14.56	 Slip YB094 LR = 27.94	 Blizzard YB108 LR = 12.23	 Havana YB009 LR = 2.26	 Sombbrero YB046 LR = 4.36	 Costa YB026 LR = 3.38	 Buru YB170 LR = 24.37	 Rum YB086 LR = 38.32



SERENITY BUBBLE COLOUR CHART

Cara

 Lomond EJ192 LR =	 Glass EJ004 LR = 46.32	 Clan EJ169 LR = 62.3	 Vit EJ184 LR =	 Beltane EJ193 LR =	 Shetland EJ191 LR =	 Hillswick EJ190 LR =	 Denny EJ196 LR =
 Maree EJ195 LR =	 Chaucer EJ172 LR = 25.94	 Ronay EJ189 LR =	 Easdale EJ188 LR =	 Austen EJ173 LR = 39.8	 Spray EJ033 LR = 16.46	 Lora EJ187 LR =	 Dolphin EJ105 LR = 35.65
 Lerwick EJ194 LR =	 Portland EJ016 LR = 14.26	 Fair Isle EJ186 LR =	 Inverness EJ175 LR = 31.48	 Lead EJ104 LR = 18.39	 Staffa EJ185 LR =	 Galilee EJ125 LR = 18.96	 Adriatic EJ154 LR = 8.79
 Lossie EJ197 LR =	 Merrick EJ048 LR = 12.23	 Carron EJ015 LR = 8.67	 Cluanie EJ180 LR = 4.13	 Tummel EJ038 LR = 6.65	 Pitlochry EJ076 LR = 8.59	 Walten EJ011 LR = 3.46	 Black EJ138 LR = 1.65

LR = Light Reflectance



ACOUSTIC PERFORMANCE

Sound absorption Coefficient - Cloudsorba Echo II (with 100mm suspension)

Frequency (Hz)	125	250	1000	2000	4000	NRC	Sound Absorption Class
Cloudsorba Echo II	0.36	0.84	1.0	1.0	1.0	0.96	A

Sound absorption Coefficient - Cloudsorba Fabric (with 100mm suspension)

Frequency (Hz)	125	250	500	1000	4000	NRC	Sound Absorption Class
Cloudsorba Fabric	0.38	0.92	0.96	0.99	0.97	0.95	A

WEIGHT

The 25mm thick Serenity Wall panels weigh approximately 3kg/m², whilst the 40mm thick Serenity Wall panels weigh approximately 4kg/m². UPVC trims weigh approx. 1kg/length.

The Serenity is available in 3 standard versions.





TYPE A ~ TEE JOINT PANEL SYSTEM



This is the most economical panel utilising white UPVC fixing sections. The panels have cut edges on all four sides. The UPVC sections serve two functions. One is to decoratively mask the edges and the other is as structural fixing sections.

This system is the most flexible as panels can be cut on site to suit wall dimensions.

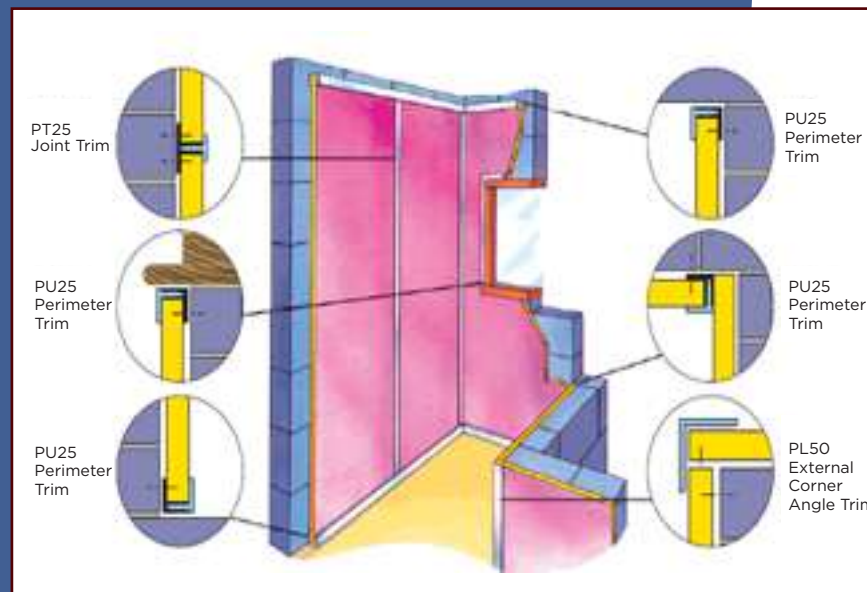

Nominal Dimension

Panel size ~ 1700mm x 1200mm

Panel thickness ~ 25mm (40mm thickness available on request)

UPVC fixings trims ~ 2700mm lengths



BUTT JOINT PANEL SYSTEM

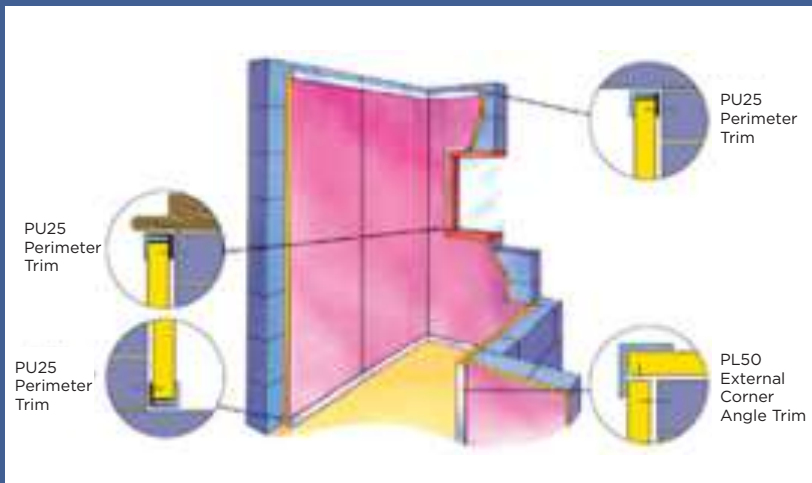

This eliminates the requirement of a tee joint section as this panel has reinforced long edges.

The fabric facing is wrapped around the two long edges of the panel.

This results in a neat, crisp butt joint between the panels.

Nominal Dimension

Panel size: 2700mm x 1200mm.

Panel thickness: 25mm (40mm thickness available on request).

UPVC fixing trims: 2700mm lengths.



SHADOW JOINT PANEL SYSTEM



Nominal Dimension

Standard sizes: 1200 x 900mm, 1200 x 1200mm,
1200 x 1500mm, 1200 x 1800mm, 1200 x 2100mm,
1200 x 2400mm, 1200 x 2700mm.

Panel thickness: 25mm (40mm thickness available on request).

Custom size panels made to customers' requirements are available

This panel has no visible fixing sections on any of the four sides of the panel. The panel has internal reinforced edges on all sides with the fabric bonded to the face and wrapped on all four sides. This results in a beautiful individual panel which can be used in single units or joined together to other panels or with shadow gaps as a design feature.



TYPE C ~ SERENITY BUBBLES

These acoustic panels have unique shapes with unsurpassed choices in shapes and colours, so that they can be visually pleasing and unique. These panels can visually lift the customers profile and tailor a noise solution for their room.

Our products are durable, they last a long time and are manufactured with materials that enables them to always keep the same shape.

The Serenity Bubble designer panels are an artistic decoration as well as being acoustic. The basic shapes lead to millions of combinations of patterns and colours. Do you love soft shapes or the strictly graphical? We have them. The products contribute to creating unique and creative spaces so that people can be comfortable both aurally and visually.





TYPE D: SERENITY WALL – ECOPAINT SURFACE FINISH



This version has an Arctic white speckled painted finish on all 6 sides, giving a crisp visually attractive appearance. The panels can be fitted as individual stand-alone panels as a design feature or can be butted together to form continuous wall linings. The perimeter edges of the panels are square edged.

These panels are NOT designed for impact resistance. If impact resistance is required, then use the fabric faced versions. The majority of the applications of these Serenity Wall - Ecopaint panels will be above door head height, out of touching reach. The panels can be fitted vertically or horizontally.

The standard Serenity Cloud - Ecopaint surface finish comes in a visually pleasing Arctic white speckled painted finish. However, they can be emulsion spray painted on site to any colour with little significant effect on acoustical performance. The panels can be painted for aesthetic reasons or even in the future to cover any dirty marks or maybe discolouration from cigarette smoke, etc.

Frequency (Hz)	125	250	500	1000	2000	4000
Quietsorba ecopaint direct fixed	0.25	0.70	0.95	1.00	1.00	1.00
Quietsorba ecopaint with 100mm air gap	0.55	0.90	1.00	1.00	1.00	1.00

NOMINAL DIMENSIONS

Standard sizes: 1200 x 1200 x 40mm thick

also: 2400 x 1200 x 40mm thick

Circle Panels: 800 diameter x 40mm thick

1200 diameter x 40mm thick

ACOUSTIC RATING

These are Class A sound absorbers. With 200mm air gap:

FIRE: The panels are Class 0 fire rated to BS476: Part 6.

WEIGHT: Nominal 4 kg/m²



ENVIRONMENT

Serenty Glass fibre sound absorbing boards consist of recovered household glass and recycled glass fibre. The fabric range used is made from 100% recycled materials saving virgin raw materials, reducing waste to landfill and minimising our damage to the environment. Made using sustainable manufacturing techniques, including green electricity, comprehensive energy and effluent management, borehole water and on-going waste saving initiatives, Second Nature fabrics leave a lighter environmental footprint. Our ethos is focused on continuing to achieve the highest environmental standards for our operations, products and innovations, engaging with, and acting responsibly towards, our local community and wider interest groups





WALL INSTALLATION

Clean white gloves must be used when handling these panels to avoid marking them. The acoustic panels are installed using impaling clips and Gluesorba contact spray adhesive.

This method allows the panels to be fixed direct to concrete, brickwork, wood, plaster, or metal. A site installation guide is sent with each delivery. The wall to which the Serenity acoustic panels are to be fixed must have a continuous solid backing wall surface, which must be level and flat.

The Serenity Impaling clips have 4mm diameter holes to take pan head screws. Using appropriate screws and plugs, etc. depending on your wall substrate, fix the correct number of impaling clips needed for the size of the panel. The larger the panel, the greater the number of impaling clips.

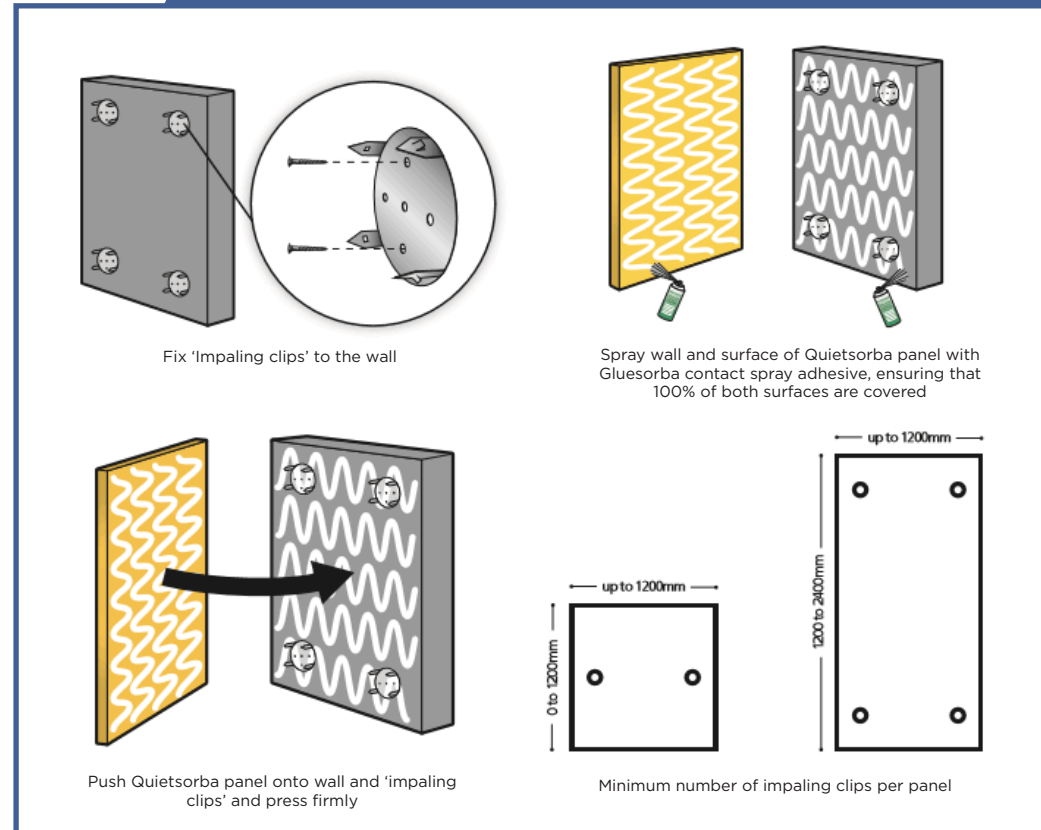



SERENITY WALL & CLOUD SORBA SHAPES

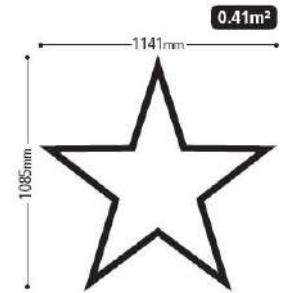
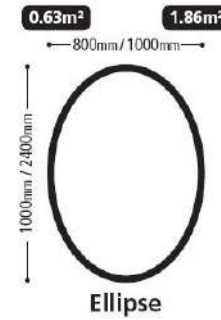
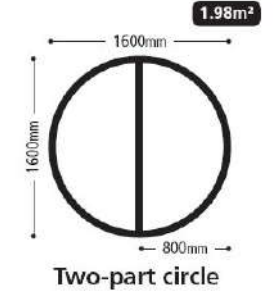
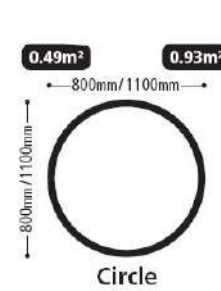
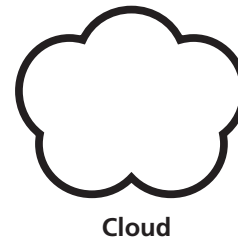
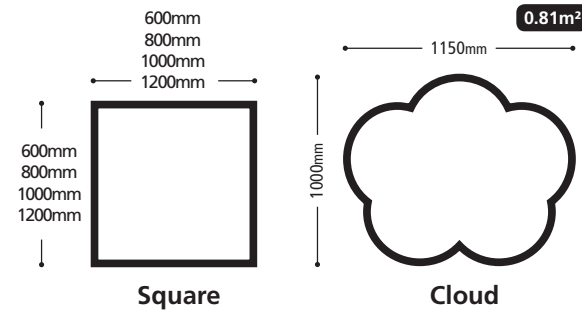
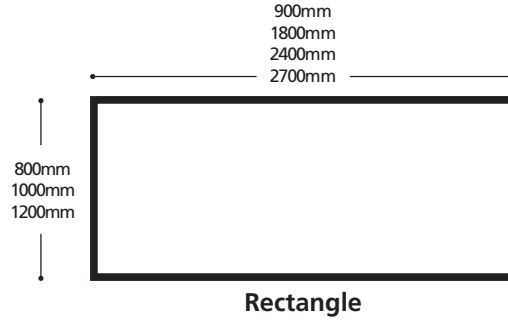
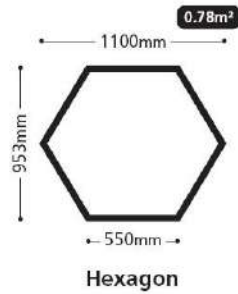
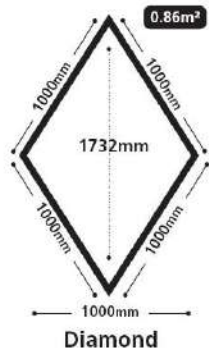
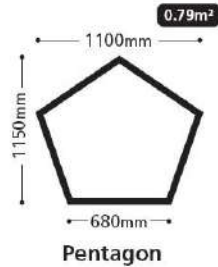
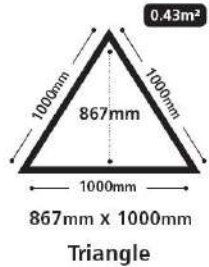



SERENITY BUBBLE SHAPES

SHAPES

We now offer a selection of 9 shapes.

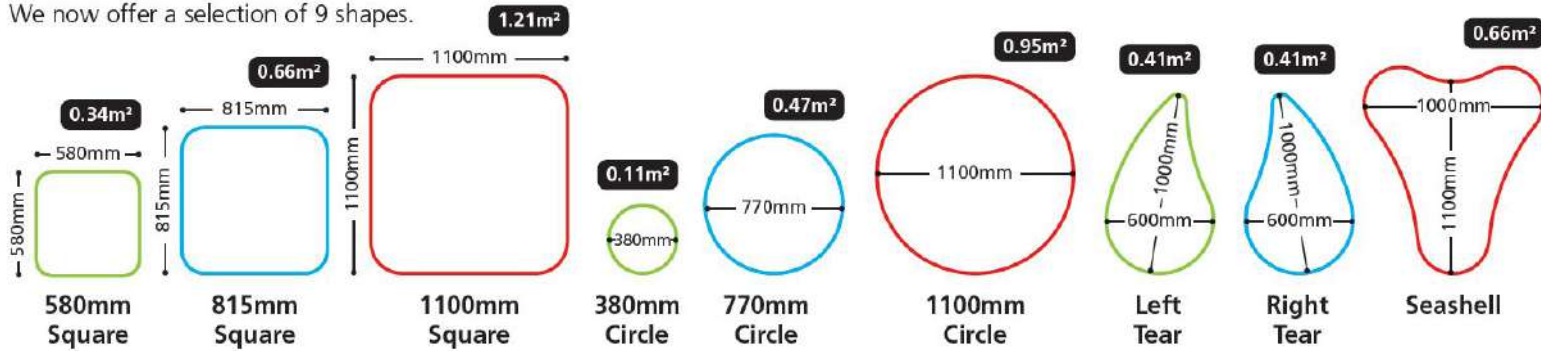

PATTERNS

We have a range of standard pattern groups for you to choose from.

Feel free to compose your own group of patterns and shapes to fit your interior at your workspace or home.

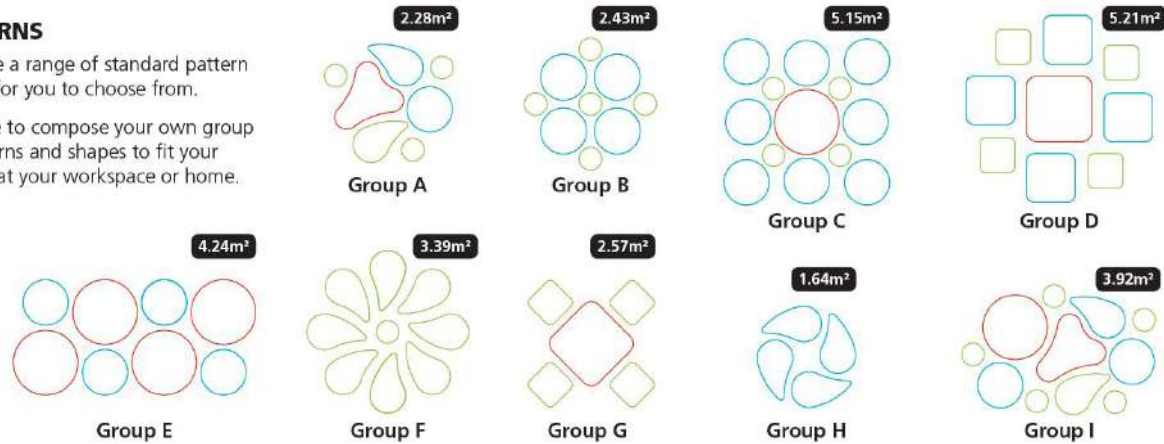



LEARN MORE

Problem

Unwanted sound is formed by waves that are reflected from solid surfaces that have limited absorption, such as wood floors, glass, walls and ceilings. Ideally, sound travels in one direction from the speaker to the listener. Today in many offices, schools, healthcare facilities, government buildings and indoor public areas (e.g. libraries, concert halls and museums), sound reflects off hard surfaces creating echoes. These echoes diminish voice intelligibility, making words hard to understand. We have all experienced acoustic “reverberation”, or echo, in large open spaces. Working or being in a noise polluted environment is stressful and reduces productivity and enjoyment.

Solution

Better acoustics requires reducing these secondary sound paths with sound absorbing materials. The Serenity acoustic panels are an ideal solution to reduce echoes in conference rooms, call centres, restaurants, hotels, houses of worship, classrooms, retail stores and movie theatres. These commercial grade panels are designed for many years of use.

Performance

The Serenity is a high specification acoustic panel system. They are durable, fire rated, visually pleasing and offer excellent acoustic performance. They are the decorative solution to your sound control needs.

Aesthetic And Design Qualities

The Serenity Wall acoustic panels will transform a stark echoing area into a warm, quieter, congenial work place. The panels have been designed with a commitment to creating a product that is as stylish as it is functional. They are manufactured from resin bonded glass fibre specifically tooled and pressed for maximum sound absorption. The panels are fabric finished hence forming an acoustic panel which is decorative, durable and resistant to mild impacts.